



# Owner's Manual

## Q2



## Foreword

### Thank you for choosing an Audi.

Your new Audi is a combination of superb craftsmanship and state-of-the-art technology. We recommend that you read this Owner's Manual carefully so that you quickly become familiar with your vehicle and can take full advantage of all its functions in everyday use.

In addition to information on how to use the controls and equipment, this Manual also contains important information on looking after your vehicle. This is relevant for your safety and will help preserve your car's value. The Manual also offers useful driving tips and advice, together with some suggestions on how to drive your car with minimum impact on the environment.

We wish you safe and enjoyable motoring with your Audi.

**AUDI AG**



#### **WARNING**

Please read the important safety information about the front passenger's airbag ⇒ *page 282*.

## Table of Contents

|  |    |   |     |
|--|----|---|-----|
| <b>Notes on this Owner's Manual</b> ..   | 6  | <b>Heating and cooling</b> .....  | 66  |
| <b>Quick reference</b> .....             | 8  | Heating system/air conditioner .....                                      | 66  |
| <b>FAQs</b> .....                        | 8  | <b>Driving</b> .....  | 72  |
| Before you set off .....                 | 8  | General notes .....   | 72  |
| Breakdowns and emergencies .....         | 8  | Steering .....  | 74  |
| Useful functions .....                   | 8  | Starting and stopping the engine<br>(vehicles with ignition lock) .....   | 74  |
| Using the infotainment system .....      | 8  | Starting and stopping the engine<br>(vehicles with convenience key) ..... | 76  |
| Communication .....                      | 8  | Driver messages .....   | 77  |
| Navigation .....                         | 9  | Starting the engine after a malfunction ..                                | 79  |
| Entertainment .....                      | 9  | Start/stop system .....   | 79  |
| Tips and tricks .....                    | 9  | Electro-mechanical parking brake .....                                    | 82  |
| <b>Cockpit</b> .....                     | 10 | Driving away from a standstill .....                                      | 83  |
| <b>Instruments and controls</b> .....    | 10 | Off-road driving .....  | 84  |
| Controls at a glance .....               | 10 | Automatic gearbox .....   | 85  |
| Instrument cluster .....                 | 12 | <b>Towing a trailer</b> .....   | 96  |
| Multi-function steering wheel plus ..... | 15 | Driving the vehicle with a trailer or<br>caravan .....                    | 96  |
| Multi-function steering wheel .....      | 18 | Removable towing bracket .....  | 99  |
| Driver information system .....          | 19 | Retrofitting .....  | 102 |
| Head-up display .....                    | 25 | <b>Driver assistance</b> .....  | 104 |
| Warning and indicator lamps .....        | 26 | <b>Driver assist systems</b> .....  | 104 |
| <b>Setting off</b> .....                 | 37 | Speed warning function .....  | 104 |
| <b>Doors and windows</b> .....           | 37 | Cruise control system .....   | 104 |
| Central locking system .....             | 37 | Speed limiter .....   | 106 |
| Boot lid .....                           | 43 | Camera-based traffic sign recognition ...                                 | 108 |
| Child locks .....                        | 46 | Rest recommendation .....   | 110 |
| Electric windows .....                   | 46 | Audi adaptive cruise control .....  | 111 |
| Panorama sun roof .....                  | 48 | Traffic jam assist .....  | 117 |
| <b>Lights and vision</b> .....           | 49 | Distance indicator and distance warning .                                 | 118 |
| Exterior lights .....                    | 49 | Driver messages .....   | 119 |
| Interior lights .....                    | 52 | Audi pre sense .....  | 120 |
| Clear vision .....                       | 53 | Audi pre sense basic .....  | 120 |
| Windscreen wipers .....                  | 55 | Audi pre sense front .....  | 121 |
| <b>Seats and storage</b> .....           | 58 | Driver messages .....   | 122 |
| General notes .....                      | 58 | Audi active lane assist .....   | 123 |
| Front seats .....                        | 58 | Audi side assist .....  | 127 |
| Head restraints .....                    | 58 | Audi drive select .....   | 131 |
| Ashtray .....                            | 59 | <b>Parking aids</b> .....   | 134 |
| Cigarette lighter .....                  | 60 | General notes .....   | 134 |
| Power sources .....                      | 60 | Rear parking aid .....  | 135 |
| Storage .....                            | 61 | Parking system plus .....   | 135 |
| Luggage compartment .....                | 62 | Reversing camera .....  | 137 |
| Roof carrier .....                       | 64 |   |     |

|   |            |   |            |
|---|------------|---|------------|
| Park assist .....                           | 139        | Option 2: Using your own SIM card .....   | 191        |
| Settings for parking aid .....              | 143        | Configuring using myAudi .....            | 196        |
| Fault warnings .....                        | 144        | Calling up Audi connect (infotainment) .. | 196        |
| Towing bracket .....                        | 144        | Audi connect infotainment services .....  | 197        |
| <b>Intelligent technology .....</b>         | <b>145</b> | Wi-Fi hotspot .....                       | 201        |
| Electronic stabilisation control (ESC) .... | 145        | Configuring the data connection .....     | 203        |
| Brakes .....                                | 147        | General notes on Audi connect             |            |
| Electro-mechanical power steering .....     | 148        | (infotainment) .....                      | 204        |
| Four-wheel drive (quattro) .....            | 148        | Troubleshooting .....                     | 205        |
| Power management .....                      | 149        | <b>Navigation .....</b>                   | <b>207</b> |
| Information saved in the control units ...  | 150        | Introduction .....                        | 207        |
| <b>Infotainment .....</b>                   | <b>152</b> | Setup .....                               | 207        |
| <b>Multi Media Interface .....</b>          | <b>152</b> | Calling up the navigation menu .....      | 207        |
| Notes on traffic safety .....               | 152        | Entering a destination .....              | 208        |
| Introduction .....                          | 152        | Personal route assist .....               | 214        |
| MMI ON/OFF button with joystick             |            | Home address .....                        | 215        |
| function .....                              | 152        | Favourites .....                          | 216        |
| Infotainment display .....                  | 153        | Directory contacts .....                  | 216        |
| How to use the MMI .....                    | 153        | Alternative routes .....                  | 216        |
| MMI touch .....                             | 155        | Other settings .....                      | 217        |
| Rotary pushbutton with joystick function    | 157        | Map .....                                 | 219        |
| Speller for letters/numbers .....           | 159        | Google Earth map display .....            | 222        |
| Search function .....                       | 160        | Map update .....                          | 223        |
| Menus and symbols .....                     | 161        | myAudi special destinations .....         | 224        |
| <b>Speech dialogue system .....</b>         | <b>164</b> | Calling up traffic information .....      | 225        |
| How to use the speech dialogue system ..    | 163        | Troubleshooting .....                     | 227        |
| Notes on the overviews of commands ...      | 164        | <b>Radio .....</b>                        | <b>228</b> |
| Commands .....                              | 165        | Calling up the radio menu .....           | 228        |
| External speech dialogue system .....       | 170        | Radio functions .....                     | 228        |
| <b>Telephone .....</b>                      | <b>172</b> | Radio menu .....                          | 230        |
| Introduction .....                          | 172        | Favourites .....                          | 231        |
| Setting up .....                            | 173        | Other settings .....                      | 231        |
| Using the Audi phone box .....              | 177        | Troubleshooting .....                     | 233        |
| Using the telephone .....                   | 178        | <b>Media .....</b>                        | <b>234</b> |
| Favourites .....                            | 181        | Introduction .....                        | 234        |
| Messages .....                              | 182        | Notes .....                               | 234        |
| Listening to voicemail messages .....       | 185        | Media drives .....                        | 235        |
| Directory .....                             | 185        | Bluetooth audio player .....              | 237        |
| Other settings .....                        | 187        | Wi-Fi audio players .....                 | 238        |
| Troubleshooting .....                       | 189        | Online media and Internet radio .....     | 239        |
| <b>Audi connect (infotainment) .....</b>    | <b>191</b> | Multimedia connections .....              | 240        |
| Introduction .....                          | 191        | Playing media .....                       | 243        |
| Option 1: Using the embedded SIM card .     | 191        | Other settings .....                      | 246        |
|   |            | Supported media and file formats .....    | 249        |
|   |            | Troubleshooting .....                     | 250        |

## Table of Contents

|  |     |   |     |
|--|-----|---|-----|
| <b>Audi smartphone interface</b> .....               | 253 | Brake fluid .....                         | 301 |
| Setting up .....                                     | 253 | Battery .....                             | 302 |
| How to use .....                                     | 254 | Windscreen washer .....                   | 303 |
| Troubleshooting .....                                | 254 | Service interval display .....            | 304 |
| <b>System settings</b> .....                         | 255 | <b>Wheels</b> .....                       | 305 |
| Setting the time and date .....                      | 255 | Tyres and rims .....                      | 305 |
| MMI settings .....                                   | 255 | Tyre pressure loss indicator .....        | 309 |
| Connection manager .....                             | 257 | <b>Care of vehicle and cleaning</b> ..... | 312 |
| System update .....                                  | 259 | General notes .....                       | 312 |
| On-board Handbook .....                              | 260 | Washing the vehicle .....                 | 312 |
| Sound settings .....                                 | 260 | Notes on cleaning and care .....          | 313 |
| Volume settings .....                                | 261 | Taking the vehicle out of service .....   | 317 |
| Restarting the MMI system .....                      | 262 | <b>Self-help</b> .....                    | 318 |
| Notes on software licences .....                     | 262 | <b>Mobility</b> .....                     | 318 |
| <b>Safety</b> .....                                  | 263 | General notes .....                       | 318 |
| <b>Safe driving</b> .....                            | 263 | Equipment .....                           | 318 |
| General notes .....                                  | 263 | Tyre repair kit .....                     | 319 |
| Correct sitting positions .....                      | 265 | Changing a wheel .....                    | 321 |
| Child seats .....                                    | 267 | Spare wheel .....                         | 324 |
| Fitting child seats .....                            | 270 | Jump-starting .....                       | 326 |
| Pedal area .....                                     | 272 | Tow-starting / towing away .....          | 328 |
| Stowing luggage safely .....                         | 272 | <b>Fuses and bulbs</b> .....              | 332 |
| <b>Seat belts</b> .....                              | 275 | Fuses .....                               | 332 |
| Why is it so important to use seat belts? ..         | 275 | Bulbs .....                               | 334 |
| Forces acting in a collision .....                   | 276 | Changing headlight bulbs .....            | 336 |
| How to wear seat belts properly .....                | 277 | Changing bulbs for rear lights .....      | 339 |
| Belt tensioners .....                                | 279 | <b>Technical data and accessories</b> ..  | 340 |
| <b>Airbag system</b> .....                           | 281 | <b>Accessories and modifications</b>      |     |
| Description of airbag system .....                   | 281 | <b>to the vehicle</b> .....               | 340 |
| Front airbags .....                                  | 282 | Accessories, replacement parts and        |     |
| Side airbags .....                                   | 285 | repairs .....                             | 340 |
| Head-protection airbags .....                        | 286 | Modifications .....                       | 340 |
| Deactivating the front passenger's airbag            | 288 | Radio transmitters and business           |     |
| <b>Service and care</b> .....                        | 289 | equipment .....                           | 340 |
| <b>Checking and topping up fluids</b> ..             | 289 | <b>Technical data</b> .....               | 342 |
| Fuel .....   | 289 | Vehicle identification data .....         | 342 |
| Filling the tank .....                               | 290 | Explanation of technical data .....       | 342 |
| Selective catalytic reduction (AdBlue/<br>DEF) ..... | 292 | Dimensions .....                          | 343 |
| Emission control systems .....                       | 295 | Capacities .....                          | 343 |
| Engine compartment .....                             | 295 | Weights .....                             | 343 |
| Engine oil .....                                     | 297 | Engine data .....                         | 344 |
| Cooling system .....                                 | 299 |   |     |

**Index** ..... 345

This Owner's Manual applies to all versions of your particular Audi model and contains important information, tips, suggestions and warnings.

Please ensure that this Owner's Manual is always kept in the vehicle. It should always be available to anyone else driving the vehicle, i.e. anyone renting, borrowing or buying the vehicle from you.

This manual describes **the equipment available for the vehicle at the time of going to print**.

Some of the equipment described here will not be available until a later date, or may only be available in certain markets.

Some sections of this Owner's Manual do not apply to all vehicles. If this is the case, a text at the start of the section indicates which vehicles it applies to, e.g. "Applies to: vehicles with cruise control system". This optional or vehicle-specific equipment is also marked with an asterisk "\*".

**Illustrations** are intended as a general guide, and may vary from the equipment fitted in your vehicle.

All references to **positions** such as "left", "right", "front" or "rear" are given as seen facing in the direction of travel.

\* Optional or vehicle-specific equipment

► The section is continued on the following page.

⇒ ⚠ Refers to a "WARNING" within the same section. If the WARNING symbol is followed by a page number the warning text referred to is included in a different section.

### **WARNING**

Texts with this symbol contain safety information. They warn you of serious dangers, possibly involving accident or injury.

### **CAUTION**

Texts with this symbol draw your attention to a possible risk of damage to your vehicle.



### **For the sake of the environment**

Texts with this symbol refer to points relevant to the protection of the environment.



### **Note**

Texts with this symbol contain additional information of a more general nature.





## FAQs

### Before you set off

- How do I adjust the seats? ⇒ *page 58.*
- How do I adjust the steering wheel?  
⇒ *page 74.*
- How does the selector lever for the automatic gearbox work? ⇒ *page 86.*
- How does the electro-mechanical parking brake work? ⇒ *page 82.*
- How do I adjust the exterior mirrors?  
⇒ *page 53.*
- How do I refuel my vehicle? ⇒ *page 290.*
- How do I refill the AdBlue tank on my diesel vehicle? ⇒ *page 293.*
- How do I operate the windscreen wipers on vehicles with rain sensor? ⇒ *page 55.*
- Where is the windscreen washer container?  
⇒ *page 297.*
- How can I store the tyre pressures?  
⇒ *page 311.*
- How do I drive with a trailer or caravan?  
⇒ *page 96.*

### Breakdowns and emergencies

- How do I jump-start the vehicle? ⇒ *page 326.*
- Where can I find the warning triangle?  
⇒ *page 318.*
- Where can I find the first-aid kit? ⇒ *page 318.*
- Where can I find the recommended tyre pressures? ⇒ *page 307.*
- Which airbags are installed in my vehicle?  
⇒ *page 281.*
- Where are the towline anchorages on the vehicle? ⇒ *page 328.*
- How can I release the tank flap manually?  
⇒ *page 291.*

### Useful functions

- How can I automatically control the distance to the vehicle in front? ⇒ *page 111, Audi adaptive cruise control.*
- How can I use the parking aid? ⇒ *page 134.*

- How can I have information projected onto the windscreen? ⇒ *page 25, Head-up display.*
- How do I operate the main beam assist for the headlights? ⇒ *page 50.*
- How can I drive off more easily? ⇒ *page 84, Driving off with the hold assist.*
- How can I stay in my lane more easily?  
⇒ *page 123, Audi active lane assist.*
- How can I check the blind spot more easily when changing lanes? ⇒ *page 127, Audi side assist.*
- How can I adjust the brightness of the instrument and display lighting? ⇒ *page 53.*
- How can I change the vehicle set-up in different driving situations depending on my personal mood and driving style? ⇒ *page 131, Audi drive select.*

### Using the infotainment system

- How do I switch on the infotainment system and adjust the volume? ⇒ *page 152.*
- How do I navigate through the infotainment menus? ⇒ *page 153, How to use the MMI.*
- How can I enter letters and numbers by handwriting? ⇒ *page 155, MMI touch.*
- How do I use the search function on the infotainment system? ⇒ *page 160, Search function.*
- How do I operate the infotainment system by voice? ⇒ *page 164.*
- Which functions can I control using the buttons on the steering wheel? ⇒ *page 15, Multi-function steering wheel plus.*
- How do I set the date and time? ⇒ *page 255.*

### Communication

- How can I connect my mobile phone to the handsfree telephone system? ⇒ *page 173.*
- How can I charge my mobile phone battery without a cable? ⇒ *page 177, Using the Audi phone box.*
- How can I control certain apps on my smartphone via the infotainment system?  
⇒ *page 253, Audi smartphone interface.*

- How can I call up information online?  
⇒ *page 191, Audi connect (infotainment).*
- How can I use the Wi-Fi hotspot? ⇒ *page 201.*

## Navigation

- What ways are there to enter a navigation destination? ⇒ *page 208.*
- How do I operate the map functions?  
⇒ *page 219.*
- How can I display traffic information?  
⇒ *page 225.*

## Entertainment

- How can I listen to the radio? ⇒ *page 228.*
- How can I play media? ⇒ *page 243.*
- How can I play music from my mobile phone via the infotainment system? ⇒ *page 237, Bluetooth audio player.*

## Tips and tricks

- How can I unlock my vehicle from inside to let passengers in? ⇒ *page 40.*
- How can I open all the windows from outside using the remote control key? ⇒ *page 47, Convenience open/close function.*
- How can I operate both sides of the air conditioner together? ⇒ *page 69.*
- How can I deactivate the front passenger's airbag? ⇒ *page 288.*
- How do I secure a child seat? ⇒ *page 270.*
- What do I have to be aware of when driving through an automatic car wash? ⇒ *page 312.*
- How can I drive (more) economically?  
⇒ *page 72.*
- How can I see when the next service date is?  
⇒ *page 304.*

## Instruments and controls

### Controls at a glance

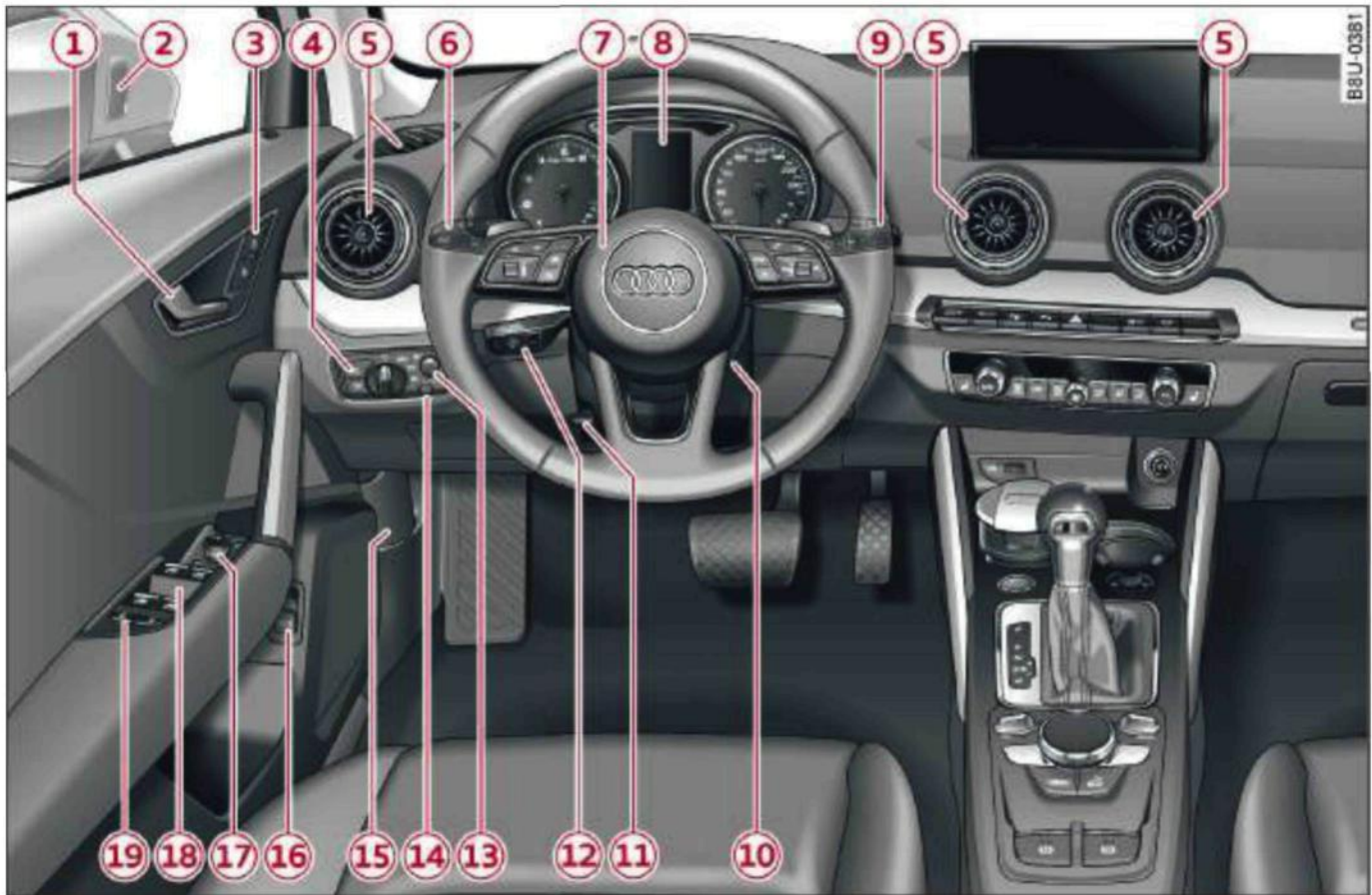

Fig. 1 Front cabin: Left side

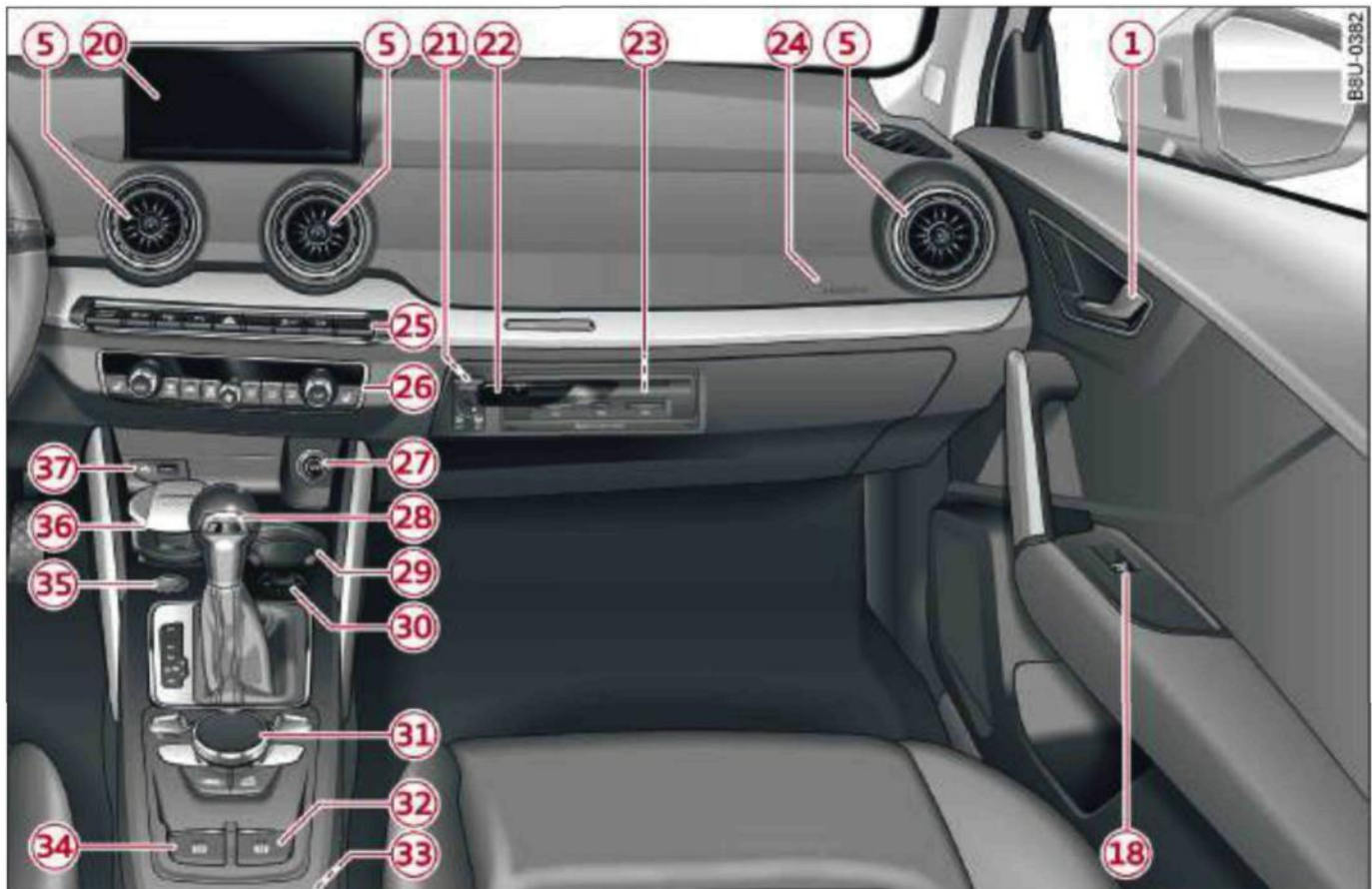



Fig. 2 Front cabin: Right side

|  |        |  |       |
|--|--------|--|-------|
| ① Door handle  |        | ②① Deactivating front passenger's airbag   | 288   |
| ② side assist  | 127    | ②② Glove box   | 61    |
| ③ Central locking switch   | 40     | ②③ Drives for CD, DVD and SIM/SD cards   | 235   |
| ④ Light switch   | 49     | ②④ Front passenger's airbag  | 282   |
| ⑤ Air outlets  | 66     | ②⑤ Depending on equipment fitted, buttons for:   |       |
| ⑥ Control lever for:   |        | – Drive select   | 131   |
| – Turn signals and main beam headlights  | 50     | – Start/stop system  | 79    |
| – Main beam assist   | 50     | – Park assist  | 139   |
| – Active lane assist   | 123    | – Parking aid  | 135   |
| – Traffic jam assist   | 117    | – Hazard warning lights  | 52    |
| ⑦ Multi-function steering wheel with:  |        | – Electronic stabilisation control (ESC)   | 145   |
| – Horn   |        | – Switching infotainment display on and off  | 153   |
| – Driver's airbag  | 282    | ②⑥ Depending on equipment fitted:  |       |
| – Controls for driver information system   | 15, 18 | – Heating/ventilation system or manual air conditioner   | 67    |
| – Controls for audio/video, telephone, navigation system and speech dialogue system        | 17, 18 | – Deluxe automatic air conditioner   | 69    |
| – Button  | 17, 18 | ②⑦ Depending on equipment fitted:  |       |
| – Paddle levers  | 90     | – Cigarette lighter  | 60    |
| ⑧ Instrument cluster   | 12     | – Electrical socket  | 60    |
| ⑨ Control lever for windscreen wipers and washer   | 55     | ②⑧ Depending on equipment fitted:  |       |
| ⑩ Steering column with optional equipment:   |        | – Gear lever (on vehicles with manual gearbox)   |       |
| – Ignition lock  | 74     | – Selector lever (for automatic gearbox)   | 85    |
| – Starting the engine after a malfunction  | 79     | ②⑨ Cup holder  | 61    |
| ⑪ Adjustable steering column   | 74     | ③⑩ On/off button for infotainment system   | 152   |
| ⑫ Control lever for:   |        | ③① Infotainment control console  | 152   |
| – Cruise control   | 104    | ③② Hold assist   | 84    |
| – Speed limiter  | 106    | ③③ Centre armrest with storage compartment and the following optional equipment:               |       |
| – Adaptive cruise control  | 111    | – Audi music interface   | 241   |
| ⑬ Depending on equipment, knob for:  |        | – AUX input/USB charging socket  | 242   |
| – Headlight range control  | 49     | – Audi smartphone interface  | 253   |
| – Head-up display  | 25     | – Audi phone box   | 177   |
| ⑭ Instrument lighting  | 53     | ③④ Electro-mechanical parking brake  | 82    |
| ⑮ Bonnet lock release  | 296    | ③⑤  button | 76    |
| ⑯ Boot lid switch  | 44     | ③⑥ Centre console with ashtray   | 59    |
| ⑰ Electric adjuster for exterior mirrors   | 53     | ③⑦ Audi music interface  | 241 ▶ |
| ⑱ Electric windows   | 46     |  |       |
| ⑲ Electric child lock  | 46     |  |       |
| ⑳ Infotainment display   | 153    |  |       |

**Note**  
 – Some of the items of equipment listed in this section are only fitted on certain models or are optional extras.

– Applies to right-hand drive vehicles: The arrangement of switches and controls may be slightly different from the layout shown on *page 10*. However, the symbols used to identify the controls are the same.

## Instrument cluster

### Instrument cluster overview

The instrument cluster is the driver's information centre.



Applies to: vehicles with Audi virtual cockpit  
**Fig. 3** Instrument cluster overview



Applies to: vehicles with analogue instrument cluster  
**Fig. 4** Instrument cluster overview

- |  |            |  |      |
|--|------------|--|------|
| ① Coolant temperature gauge . . . . .        | 13         | ④ Central area with:   |      |
| ② Rev counter . . . . .                      | 13         | – Display . . . . .  | 14   |
| – with status display <b>OFF</b> . . . . .   | 74, 76     | – Driver information system (Audi virtual cockpit) * . . . . . | 19 ▶ |
| – with status display <b>READY</b> . . . . . | 74, 76, 79 |  |      |
| ③ Tab area*                                  |            |  |      |

|   |    |
|---|----|
| – Driver information system (analogue instrument cluster)* . . . .    | 19 |
| – Warning and indicator lamps . . .                                   | 26 |
| ⑤ Status line (displayed on one or two lines)                         |    |
| ⑥ Reset button for trip recorder . . .                                | 14 |
| ⑦ Speedometer/convenience display                                     |    |
| ⑧ Fuel gauge . . . . .  | 14 |
| ⑨ Speedometer   |    |
| ⑩ Additional display on left (two separate sections in extended view) |    |

Further warning/indicator lamps may appear in the rev counter ②, in the speedometer ⑦, in the status line ⑤ and above or below the central area ④, depending on the instrument cluster version.

Most of the illustrations on the following pages show the colour analogue instrument cluster\*. The display and position of the elements may be different on the monochrome instrument cluster or the Audi virtual cockpit\*.

**i Note**

- Depending on the vehicle equipment, the instrument lighting (for dials and needles) may be switched on when the ignition is on and the vehicle's lights are off. The illumination of the dials and needles is automatically reduced as it becomes dark outside and is eventually switched off altogether. This function is intended to remind the driver to switch on the dipped headlights in good time.
- You can change the measurement units for temperature or speed, etc. via the infotainment system ⇒ page 255.

**Coolant temperature gauge**

The coolant temperature gauge ① ⇒ page 12, Fig. 4 / ⇒ page 12, Fig. 3 only works when the ignition is switched on. In order to avoid possible damage to the engine, please read the following notes for the different temperature ranges.

**Engine cold**

If the LEDs are still in the lower range of the display, this indicates that the engine has not yet reached operating temperature. Avoid high engine speeds, full acceleration and heavy engine loads.

**Normal temperature**

The LEDs will settle somewhere in the centre of the display once the engine has reached operating temperature. If the warning lamp  lights up in the instrument cluster display, the coolant temperature is too high ⇒ page 30.

**! CAUTION**

- Additional lights and other accessories in front of the air inlet reduce the cooling effect of the radiator. At high outside temperatures and high engine loads, there is a risk of the engine overheating.
- The front spoiler also ensures proper distribution of the cooling air when the vehicle is moving. If the spoiler is damaged this can reduce the cooling effect, which could cause the engine to overheat. Obtain professional assistance.

**i Note**

Applies to: vehicles with diesel engine  
 These engines are so efficient that they may not reach their full operating temperature in very cold weather. This is quite normal and no cause for concern.

**Rev counter**

*The rev counter indicates the number of engine revolutions per minute.*

The start of the red zone on the dial indicates the maximum engine speed which may be used briefly in all gears when the engine is warm and after it has been run in properly. However, it is advisable to change up a gear or move the selector lever to D/S (or lift your foot off the accelerator) before the needle reaches the red zone. ►

**! CAUTION**

The rev counter needle **2** ⇒ page 12, Fig. 4 / ⇒ page 12, Fig. 3 must only ever briefly go into the red zone on the scale; otherwise there is a risk of engine damage. The start of the red zone on the dial is different for some engine versions.

**🌿 For the sake of the environment**

Changing up a gear early will help you to save fuel and minimise engine noise.

**Fuel gauge**

The gauge **8** ⇒ page 12, Fig. 4 / ⇒ page 12, Fig. 3 only works when the ignition is switched on. When the gauge reaches the reserve zone, a red LED will light up and the indicator lamp **🛢️** will appear ⇒ page 35. The LED will flash in red if the fuel level is very low.

The tank capacity of your vehicle is given in the Technical data section ⇒ page 343.

**! CAUTION**

Never run the tank completely dry. If there is an irregular fuel supply, misfiring can occur. Unburnt fuel can then enter the exhaust system. This can lead to overheating and damage to the catalytic converter.

**Mileage recorder**

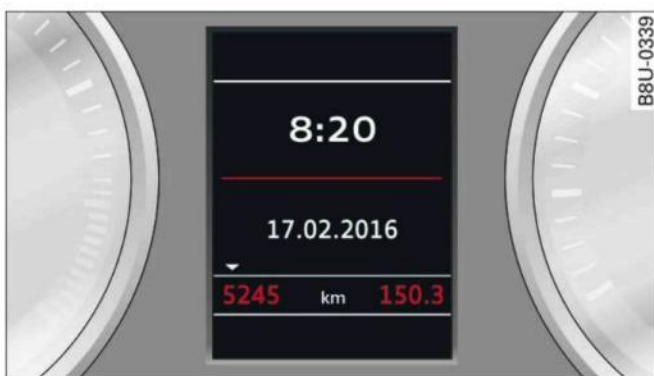

Fig. 5 Instrument cluster: Mileage recorder

**Trip recorder/odometer**

The trip recorder shows the distance that has been travelled since it was last reset. It is used to measure individual journeys.

The trip recorder can be reset to zero by pressing the reset button **6** ⇒ page 12, Fig. 4 / ⇒ page 12, Fig. 3.

The odometer records the vehicle's total mileage.

**Fault display**

If there is a fault in the instruments, the letters **DEF** appear in the trip recorder display. Have the fault rectified as soon as possible.

**Display**

Applies to: vehicles without driver information system



Fig. 6 Instrument cluster: Display without driver information system

Depending on the vehicle equipment, the instrument cluster display shows the following (as applicable):

- Time and date ⇒ page 255
- Remaining range ⇒ page 14
- Driver messages and warning/indicator lamps\* ⇒ page 26
- Mileage and trip recorder ⇒ page 14

**Gear-change indicator**

Applies to: vehicles with gear-change indicator

*This additional indicator function can help to save fuel.*

To familiarise yourself with the gear-change indicator, drive in the normal way to start with. A gear change will be recommended on the instrument cluster display if the gear you are in is not the most economical choice. If no gear change is recommended, you are already in the most economical gear. ▶



**Vehicles with manual gearbox**

- **Shifting up a gear:** The suggested gear appears to the **right** of the current gear when a higher gear is recommended.
- ◄ **Shifting down a gear:** The suggested gear appears to the **left** of the current gear when a lower gear is recommended.

The gear you are currently in and the recommended gear will be displayed. Gears may occasionally be skipped (3 ► 5).

Vehicles with start/stop system: If all the conditions for a stop phase ⇒ *page 79* have been met, but the gear lever is in gear with the clutch depressed, the gear change indicator will recommend changing to ►N. Put the gear lever in neutral and take your foot off the clutch pedal. The start/stop system will automatically switch off the engine.

**Vehicles with automatic gearbox**

The display is only visible in tiptronic mode ⇒ *page 90*.

The symbol ↑ after the current gear means **change up a gear**.

**! CAUTION**

The gear-change indicator is intended to help save fuel. It is not intended to recommend the right gear for all driving situations. In certain situations, only the driver can choose the correct gear (for instance when overtaking, driving up a steep gradient or towing a trailer).

**i Note**

Applies to: vehicles with manual gearbox  
The gear-change indicator in the instrument cluster goes out when you press the clutch pedal.

**Outside temperature display**

When the vehicle is stationary or travelling at very low speeds, the temperature displayed may be slightly higher than the actual outside tem-

perature as a result of the heat radiated from the engine.

At temperatures below +5°C a snowflake symbol appears next to the temperature display ⇒ ⚠.

**! WARNING**  
Do not rely on the outside temperature display as an ice warning. Bear in mind that there may be patches of ice on the roads even at outside temperatures around +5 °C – risk of accident!

**Multi-function steering wheel plus**

**How to use the multi-function steering wheel**

Applies to: vehicles with Audi virtual cockpit

*You can use the multi-function steering wheel to control the driver information system and MMI functions, adjust the volume and switch the speech dialogue system on/off.*



**Fig. 7** Example: Driver information system display (Audi virtual cockpit)

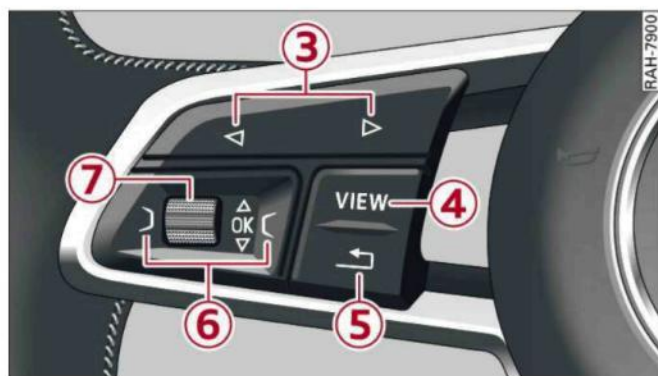

**Fig. 8** Left side of multi-function steering wheel plus

**Important:** The ignition must be switched on. ►

The driver information system shows information ② in several display tabs ① ⇒ Fig. 7.

The equipment installed on your vehicle determines which of the following tabs are available:

|                       |   |
|-----------------------|---|
| 1st tab               | On-board computer ⇒ <i>page 19</i>                    |
| 2nd tab <sup>a)</sup> | Driver messages                                       |
| 3rd tab               | Radio ⇒ <i>page 22</i><br>Media ⇒ <i>page 22</i>      |
| 4th tab               | Telephone* ⇒ <i>page 23</i>                           |
| 5th tab               | Navigation* ⇒ <i>page 24</i><br>Map* ⇒ <i>page 24</i> |

a) This tab is only visible if one or more warning/indicator lamps or driver messages are displayed.

### ③ ◀▶ button

– **To switch between tabs:** Press the button ◀▶ repeatedly until the desired tab is displayed (e.g. Radio).

### ④ VIEW button

To change the view: see ⇒ *page 17, Changing views*.

### ⑤ ⇨ button

To return to the previous function level.

### ⑥ Control buttons ▢ and ▣

To call up/close the selection menu or options menu ⇒ *page 16*.

### ⑦ Left thumbwheel

- **To select a function in a menu/list:** Scroll the left thumbwheel to the desired function (e.g. setting a frequency).
- **To confirm your selection:** Press the left thumbwheel ⑦ ⇒ Fig. 8.
- **To zoom in/out of the map:** When a map is shown on the display, scroll the left thumbwheel to make the map scale larger or smaller.

## Control buttons

Applies to: vehicles with Audi virtual cockpit

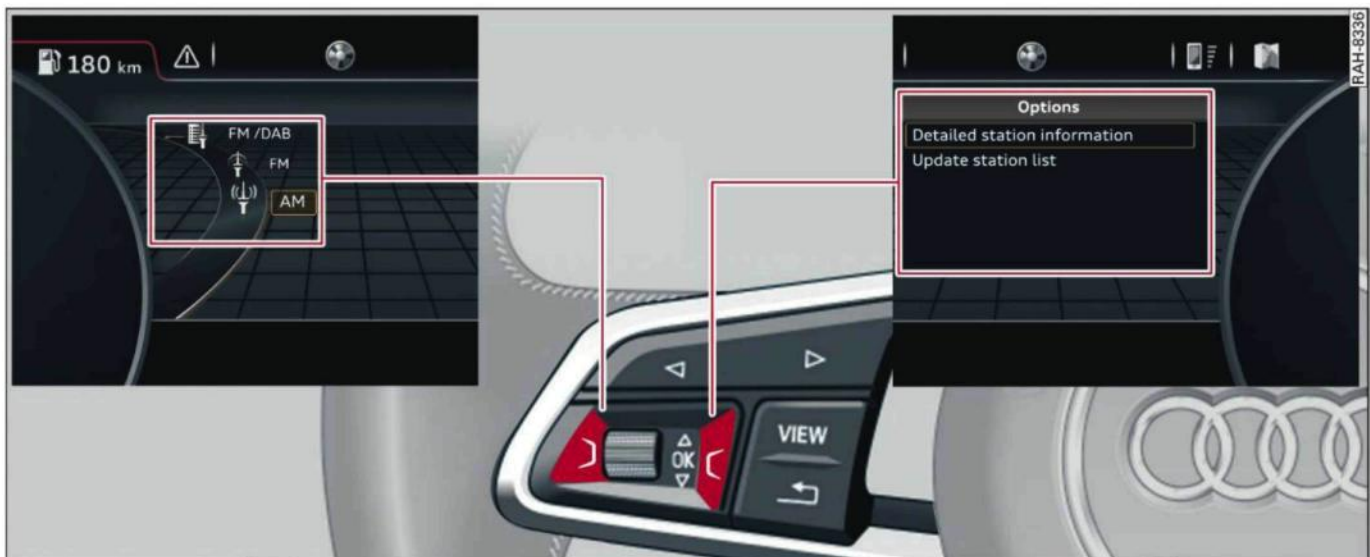

Fig. 9 Selection menu and options menu

### Left control button

– **To call up/close the selection menu:** Press the left control button ⇒ Fig. 9 on the multi-function steering wheel. You can use the left thumbwheel to select and confirm a function in

the selection menu (e.g. to select a new waveband).

### Right control button

– **To call up/close the options menu:** Press the right control button ⇒ Fig. 9 on the multi-function steering wheel. You can use the left thumbwheel in the options menu to select context-sensitive functions or change certain settings (e.g. extended programme information).

#### **i** Note

Whether a selection menu or options menu is available depends on the function you have selected.

### Changing views

Applies to: vehicles with Audi virtual cockpit



Fig. 10 Extended view



Fig. 11 Classic view

– **To change views:** Press the **VIEW** button ④ ⇒ page 15, Fig. 8 to switch from the classic view ⇒ Fig. 11 to the extended view ⇒ Fig. 10. Press the **VIEW** button again to return to the classic view.

### Further function selector buttons

Applies to: vehicles with Audi virtual cockpit



Fig. 12 Right side of multi-function steering wheel plus

#### ① button

- **To answer a call:** Press the button when there is an incoming call.
- **To end a call:** Press the button during a call.
- **To display the call list:** Press the button while no calls are active and there are no incoming calls.

#### ② button

- **To switch on the speech dialogue system:** Briefly press the button. Give a spoken command after the **beep** signal.
- **To switch off the speech dialogue system:** Press and hold the button for several seconds. **Or:** Say the command **Cancel**.

For more information about the speech dialogue system, refer to ⇒ page 164, *Speech dialogue system*.

#### ③ Right thumbwheel

You can adjust the volume of an audio source or system message (e.g. during a speech dialogue) directly while it is being played.

- **Volume up/down:** Scroll the right thumbwheel up/down.
- **Mute/pause:** Scroll the right thumbwheel down. **Or:** Press the right thumbwheel.
- **Unmute/resume:** Scroll the right thumbwheel upwards. **Or:** Press the right thumbwheel.

#### ④ / button

- **To select the previous/next track or station:** Press the or button.

- **To fast forward/rewind an audio file:** Press and hold the or button until the desired playing position has been reached.

**5** button

- **To call up the user-assigned function:** Press the button on the multi-function steering wheel.
- **To check which function is assigned:** Press and hold the button.
- **To change the assigned function:** Select: **MENU** button > **Car** > left control button > **Vehicle settings** > **Steering wheel button**.

**6** button

- **To have the last navigation cue repeated:** Press the button while route guidance is active.
- **To adjust the volume of the navigation cues:** Scroll the right thumbwheel up/down during route guidance while a navigation cue is being spoken.

## Multi-function steering wheel

### How to use the multi-function steering wheel

Applies to: vehicles with analogue instrument cluster

You can use the multi-function steering wheel to control the driver information system and certain MMI functions and to adjust the volume.



Fig. 13 Left side of multi-function steering wheel

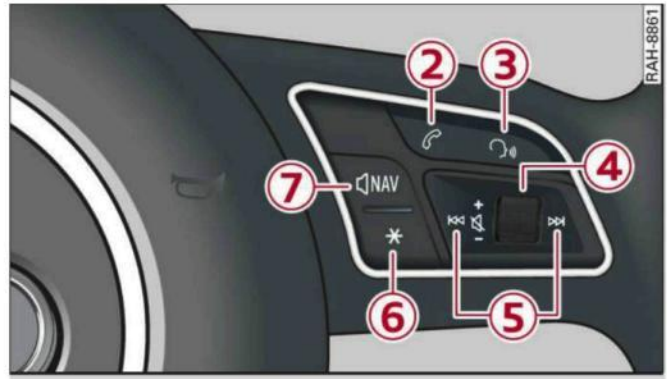

Fig. 14 Right side of multi-function steering wheel

Important: The ignition must be switched on.

**1** How to use the driver information system

The driver information system shows information **2** ⇒ page 15, Fig. 7 in several display tabs **1** ⇒ page 15, Fig. 7.

The equipment installed on your vehicle determines which of the following tabs are available:

|                       |                                    |
|-----------------------|------------------------------------|
| 1st tab               | On-board computer ⇒ page 20        |
| 2nd tab <sup>a)</sup> | Driver messages                    |
| 3rd tab               | Radio ⇒ page 22<br>Media ⇒ page 22 |
| 4th tab               | Telephone* ⇒ page 23               |
| 5th tab               | Navigation* ⇒ page 24              |



<sup>a)</sup> This tab is only visible if one or more warning/indicator lamps or driver messages are displayed.

- **To switch between tabs:** Press the button repeatedly until the desired tab is displayed.
- **To call up/close a menu:** Press the button.
- **To select a function in a menu/list:** Scroll the left thumbwheel to the desired function.
- **To confirm the selection:** Press the left thumbwheel to confirm your selection.
- **To return to the previous function level:** Press the button.
- **To scroll through lists:** Scroll the left thumbwheel quickly.

**2** button

- **To answer a call:** Press the button when there is an incoming call.
- **To end a call:** Press the button during a call.
- **To display the call list:** Press the button while no calls are active and there are no incoming calls.

**③  button**

- **To switch on the speech dialogue system:** Briefly press the  button. Give a spoken command after the **beep** signal.
- **To switch off the speech dialogue system:** Press and hold the  button for several seconds. **Or:** Say the command **Cancel**.





For more information about the speech dialogue system, refer to ⇒ *page 164, Speech dialogue system*.

**④ Right thumbwheel**



You can adjust the volume of an audio source or system message (e.g. during a speech dialogue) directly while it is being played.

- **Volume up/down:** Scroll the right thumbwheel up/down.
- **Mute/pause:** Scroll the right thumbwheel down. **Or:** Press the right thumbwheel.
- **Unmute/resume:** Scroll the right thumbwheel upwards. **Or:** Press the right thumbwheel.

**⑤  /  button**

- **To select the previous/next track or station:** Press the  or  button.
- **To fast forward/rewind an audio file:** Press and hold the  or  button until the desired playing position has been reached.

**⑥  button**

- **To call up the user-assigned function:** Press the  button on the multi-function steering wheel.
- **To check which function is assigned:** Press and hold the  button.
- **To change the assigned function:** Select: **MENU** button > **Car** > left control button > **Vehicle settings** > **Steering wheel button**.

**⑦  button**

- **To have the last navigation cue repeated:** Press the  button while route guidance is active.
- **To adjust the volume of the navigation cues:** Scroll the right thumbwheel up/down during route guidance while a navigation cue is being spoken.

## Driver information system

**On-board computer (Audi virtual cockpit)**

Applies to: vehicles with Audi virtual cockpit



**Fig. 15** Instrument cluster: Consumption display

**Resetting values to zero**

Important: The **consumption, short-term memory** or **long-term memory** display must be selected.

- ▶ To reset the figures in the selected memory to zero, press the left thumbwheel **⑦** ⇒ *page 15, Fig. 8* on the multi-function steering wheel for one second. **Or:**
- ▶ On the multi-function steering wheel, select right control button > **Reset values\***.

**Changing settings for additional display**

The additional displays that can be selected vary depending on the equipment installed on your vehicle.

- ▶ On the multi-function steering wheel, select right control button > **Additional display**.
- ▶ Select the desired additional display.

**Calling up vehicle functions**

- ▶ Call up the first tab (on-board computer) using the  button on the multi-function steering wheel.

The equipment installed on your vehicle determines which of the following displays are available:

- Date and time ⇒ *page 255*
- Average fuel consumption
- AdBlue range ⇒ *page 292*
- Single journey memory summary

- Total journey memory summary
- Energy consumers ⇒ *page 20*
- Driver assistance ⇒ *page 104*
- Traffic sign recognition ⇒ *page 108*

The single journey memory processes the information on a journey from the time the ignition is switched on until it is switched off. If the journey is resumed within two hours after the ignition is switched off, the new figures are automatically included in the calculation.

Unlike the single journey memory, the total journey memory is not erased automatically. In this way, you can determine the period for which you wish the on-board computer to supply driving information.

### Fuel consumption

The current fuel consumption can be shown in a bar display ⇒ *Fig. 15*. The average fuel consumption from the single journey memory can also be displayed. If the bar turns green, your vehicle is saving fuel using the following function:

- **Recuperation:** Electrical energy can be stored in the battery (recuperation) if the vehicle is travelling downhill or coasting in gear (overrun). In this case, the bar will move towards the  symbol.
- **Active Cylinder Management\*:** The engine automatically shuts down two cylinders when performance demand is low and certain other conditions have been met. This process is imperceptible to the occupants. The driver message **2-cylinder mode** will appear if the average fuel consumption display ⇒ *Fig. 15* is selected in the instrument cluster. The cylinders are reactivated under heavier load conditions.

### Energy consumers\*

In the **Energy consumers** view, auxiliary equipment currently affecting the vehicle's fuel consumption is listed. The display shows up to three energy consumers. The energy consumer drawing the most power appears at the top of the list. If more than three energy consumers are switched on, the ones currently using the most power are displayed. In addition, a scale indi-

cates the overall current fuel consumption of all energy consumers.

### Economy tips

Applies to: vehicles with Audi drive select and efficiency mode

In **efficiency** mode, economy tips are shown briefly on the instrument cluster display in certain situations where fuel economy is affected. By following these economy tips, you can save fuel.

To clear an economy tip from the display immediately, press the left thumbwheel on the multi-function steering wheel.

**To activate/deactivate economy tips:** Select the following on the infotainment system: **MENU** button > **Car** > **Audi drive select**. Select: **efficiency** > right control button > **Economy tips**.

### Note

- The date, the time and the time/date display format can be changed via the infotainment system ⇒ *page 255*.
- The economy tips are not always displayed in every conceivable situation, but are deliberately spaced out over time.
- Once you have cleared an economy tip from the display, it will not appear again until the next time you switch on the ignition.

### On-board computer (analogue instrument cluster)

Applies to: vehicles with analogue instrument cluster





Fig. 16 Instrument cluster: Consumption display

### Resetting values to zero



- ▶ Press the  button on the multi-function steering wheel and select **On-board computer** or **Efficiency program** from the menu. ▶

- ▶ To reset the figures in the selected memory to zero, press the left thumbwheel  ⇒ *page 18, Fig. 13* on the multi-function steering wheel for one second.

### Calling up vehicle functions



- ▶ Call up the first tab (on-board computer) using the  button on the multi-function steering wheel.
- ▶ Press the  button on the multi-function steering wheel and select **Vehicle functions** from the menu.

The equipment installed on your vehicle determines which of the following displays are available:

- On-board computer ,  ⇒ *page 21*
- Efficiency program  ⇒ *page 21*
- Digital speedometer
- Assists ⇒ *page 104*
- Traffic signs ⇒ *page 108*
- Reduced display

### On-board computer

On the on-board computer you can call up the following displays in turn by scrolling the left thumbwheel on the multi-function steering wheel:

- Date ⇒ *page 255*
- Range
- AdBlue range\* ⇒ *page 292*
- Short-term memory 
- Average fuel consumption
- Long-term memory 

The single journey memory processes the information on a journey from the time the ignition is switched on until it is switched off. If the journey is resumed within two hours after the ignition is switched off, the new figures are automatically included in the calculation.

Unlike the single journey memory, the total journey memory is not erased automatically. In this way, you can determine the period for which you wish the on-board computer to supply driving information.

The following additional display may be available in the on-board computer, depending on the vehicle equipment:

- **Active Cylinder Management:** The engine automatically shuts down two cylinders when performance demand is low and certain other conditions have been met. This process is imperceptible to the occupants. The driver message **2-cylinder mode** will appear if the current or average fuel consumption display ⇒ *Fig. 16* is selected in the instrument cluster. The cylinders are reactivated under heavier load conditions.

### Efficiency program

Applies to: vehicles with efficiency program

The efficiency program can help to save fuel. It evaluates fuel efficiency data, shows a list of auxiliary equipment affecting fuel consumption, and suggests gear changes. It also provides economy tips for saving fuel.

The efficiency program uses the trip and fuel consumption data from the short-term memory. When you clear the data from the efficiency program, the values in the short-term memory are reset to zero.

The following additional displays are available in the efficiency program, depending on the vehicle equipment:

- **Advanced gear-change indicator:** The advanced gear-change indicator is based on the same logic as the “regular” gear-change indicator. The “regular” gear-change indicator disappears from the display when the advanced gear-change indicator appears ⇒ *page 14*.
- **Energy consumers:** The efficiency program shows a list of energy consumers currently affecting the vehicle's fuel consumption. The display shows up to three energy consumers. The energy consumer drawing the most power appears at the top of the list. If more than three energy consumers are switched on, the ones currently using the most power are displayed. In addition, a scale indicates the overall current fuel consumption of all energy consumers.
- **Economy tips:** Economy tips will automatically appear intermittently in the efficiency program ▶

in certain situations. By following these economy tips, you can save fuel. To clear an economy tip from the display immediately, press any of the controls on the multi-function steering wheel.

### Note

The date, the time and the time/date display format can be changed via the infotainment system ⇒ *page 255*.

## Radio

Important: Radio mode must be activated ⇒ *page 228*, and the radio/media tab must be displayed.

- ▶ Press the  button or the left control button ⇒ *page 16*, depending on the equipment in your vehicle.

The following functions are available on the driver information system, depending on the vehicle equipment:

- **To set the waveband:** Select and confirm the waveband.
- **To tune to a station from the memory list\*:** Select **Memory** > *desired radio station*.
- **To tune to a station from the station list\*:** Select and confirm a radio station.
- **To tune to a station from the favourites list:** Select **Favourites** > *desired radio station*.
- **To call up a media source:** Select and confirm **To media**.

### Other settings

Applies to: vehicles with Audi virtual cockpit

- Select: right control button > *desired entry*.

The following settings are available depending on which function is selected:

- **Update station list\*:** see ⇒ *page 232*.
- **Detailed station information:** See ⇒ *page 232*.

## Media

Important: A media drive must contain audio/video files ⇒ *page 235*, and the radio/media tab must be displayed.

- ▶ Press the  button or the left control button ⇒ *page 16*, depending on the equipment in your vehicle.

The following functions are available on the driver information system, depending on the vehicle equipment:

- **To select a media source:** Select and confirm a media source, e.g. “SD card”.
- **To play an audio/video file:** Select and confirm a track/file.
- **To pause/resume playback:** Press the right thumbwheel  ⇒ *page 17, Fig. 12*. To continue playback, press the right thumbwheel again.
- **To restart playback of an audio file:** Select the track currently playing if it is not already selected and press the left thumbwheel.

Applies to: vehicles with analogue instrument cluster

- **To switch to the radio:** Select and confirm a waveband (e.g. **FM**).

Applies to: vehicles with Audi virtual cockpit

- **To switch to radio:** Select and confirm **To radio**.
- **To call up detailed track information:** Select the right control button > **Detailed track information**. For more information, please refer to ⇒ *page 246*.

### Note

- The MMI media drives do not support DRM-protected files; these files are marked with the symbol .
- Please note that when you are using the driver information system to control playback within a media source, only the playlist selected on the MMI control console can be played ⇒ *page 244*.
- Always note the information on the infotainment display. It may be necessary to use the MMI control console to operate certain functions.



## Telephone

Applies to: vehicles with telephone

**Important:** A mobile phone must be connected to the MMI ⇒ *page 173*, and the telephone tab must be displayed.

- ▶ Press the  button or the left control button ⇒ *page 16*, depending on the equipment in your vehicle.

The following functions are available on the driver information system, depending on the vehicle equipment:

- **To call a contact:** Select and confirm **Call list / Favourites / Directory**. Select and confirm a contact.
- **Directory contacts:** Only directory contacts for which a telephone number is stored are displayed in the driver information system. If several telephone numbers are stored for one contact, the list of stored telephone numbers is displayed first when the contact is selected. For more information on the symbols displayed, refer to ⇒ *page 185*.
- **Call list:** The call lists contain all received, placed and missed calls.
- **Caller information\*:** Depending on whether the caller is stored in the directory and whether the telephone number is transmitted with the call, the *name*, the *telephone number* or **Unknown** will appear on the display of the driver information system.

### Functions for an incoming call

- **To answer a call:** Press the left thumbwheel when there is an incoming call.
- **To ignore a call:** Select and confirm **Ignore** when there is an incoming call.
- **To end a call:** Select and confirm **End call**.

### Functions during a call

Applies to: vehicles with analogue instrument cluster

- **To make a further call:** Select **Hold** >  button > **Directory** or **Call list** > *entry in list*.
- **To answer a further call when you are talking on the phone and have another call on hold:** Select and confirm **Replace**. The current call will be replaced by the incoming call.

Applies to: vehicles with Audi virtual cockpit

- **To make a further call:** Select **Hold** > left control button > **Directory** or **Call list** > *entry in list*.
- **To answer a further call when you are talking on the phone and have another call on hold:** Select and confirm **Answer**. The current call will be replaced by the incoming call.

Other functions are:

**Microphone off:** If you select and confirm this option, the caller will no longer be able to hear you; you will still be able to hear the caller.

**Hold/Resume:** You can put a call on hold and retrieve it from the hold queue later.

**Switch:** You can switch between two phone calls (one of them will be on hold at any given time). Select **End call** to end whichever call is active. The call on hold will remain in the hold queue and can be retrieved by selecting **Resume**.

**Conference:** Up to five callers and one caller on hold can take part in a conference (depending on the mobile network provider). To set up a further call, select **Hold** to place all the members of an existing conference on hold. You can then press the left control button to place another call to a contact in the directory or the call list. Select **Resume** if you want to retrieve all participants in an existing conference from the hold queue.

### Note

- The functions of the telephone can be operated using the multi-function steering wheel only if the telephone equipment was installed *at the factory*.
- The functions of the telephone depend on your mobile phone and whether they are supported by your mobile network service provider.
- The option **Call waiting** must be activated on your mobile phone and on the MMI for you to be made aware of incoming calls during a conversation. The call options depend on your mobile network service provider. For more information, contact your service provider.

### Navigation

Applies to: vehicles with navigation system

Important: The navigation tab must be displayed.

If route guidance has not been started, the driver information system display will show a compass. On vehicles with the Audi virtual cockpit\*, the map will be displayed.

▶ Press the  button or the left control button ⇒ *page 16*, depending on the equipment in your vehicle.

The following functions are available on the driver information system, depending on the vehicle equipment:

- **To call up recent destinations:** Select and confirm **Last destinations** > *desired destination*.
- **To call up favourites\*:** Select and confirm **Favourites** > *desired destination*.

Applies to: vehicles with analogue instrument cluster

- **To display the navigation screen when route guidance is active:** Select and confirm **Route guidance**.
- **To display the compass when route guidance is not active:** Select and confirm **Compass**.
- **To start route guidance to the stored home address:** If applicable, first select and confirm **Stop route guidance**, and then select **Favourites** > **Home address**.
- **To cancel the active route guidance:** Select and confirm **Stop route guidance**.

Applies to: vehicles with Audi virtual cockpit

- **To start route guidance to the stored home address:** If applicable, first select and confirm **Stop route guidance**, and then select **Favourites** > **Home address**.
- **To cancel the active route guidance:** Select right control button > **Stop route guidance**.

### Other settings

Applies to: vehicles with Audi virtual cockpit

- Select: right control button > *desired entry*.

The following settings are available depending on the equipment on your vehicle and on which function is selected:

- **Map display** ⇒ *page 221*

- **Map colours** ⇒ *page 221*
- **Map orientation** ⇒ *page 221*
- **Automatic zoom** ⇒ *page 221*

### Navigation view when route guidance is started

Applies to: vehicles with navigation system and Audi virtual cockpit



Fig. 17 Illustration: Standard map when route guidance is activated (Audi virtual cockpit)

Important: A destination must have been entered ⇒ *page 208*, the route guidance function must have been started, and the navigation tab must be displayed.

Depending on the vehicle equipment and on the view selected ⇒ *page 17*, the following information is displayed on the driver information system.

- ① Map contents (e.g. special destinations or traffic information)
- ② Current vehicle position (📍)
- ③ A bar graph appears when you approach a turn-off. The fewer bars are displayed, the shorter the distance to the turn-off point. If there is no impending turn-off, the remaining distance to the destination/stopover is shown on the right-hand speedometer along with the estimated arrival time.
- ④ Name of the street you are currently on.

**Street view when route guidance is started**

Applies to: vehicles with navigation system and analogue instrument cluster

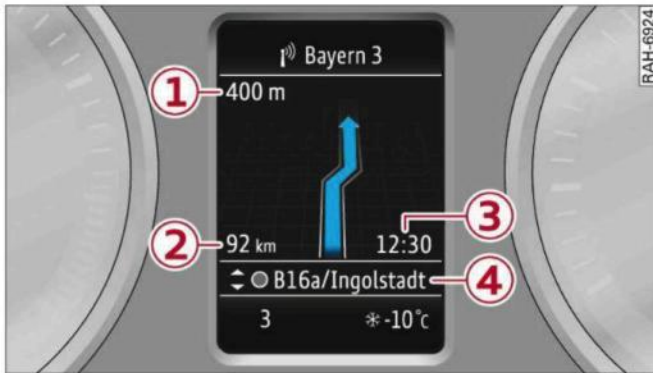

Fig. 18 Example: Lane change in instrument cluster

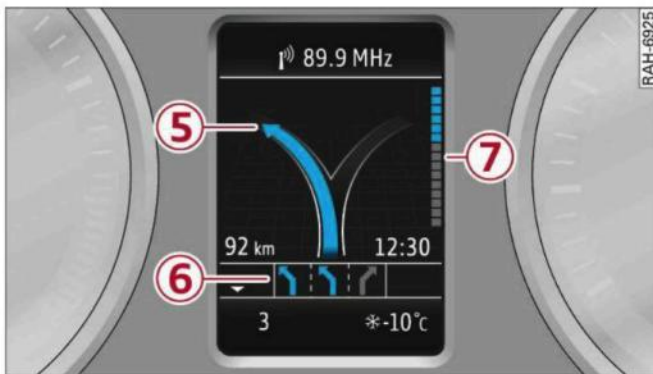

Fig. 19 Example: Turn-off in instrument cluster

Important: A destination must have been entered ⇒ page 208, the route guidance function must have been started, and the navigation tab must be displayed.

The following information is displayed on the driver information system, depending on the equipment installed in your vehicle:

- ① Distance to next manoeuvre
- ② Distance to destination/stopover
- ③ Estimated time of arrival
- ④ Name of motorway, major road or street you are driving on. If the symbol is displayed in front of the street name, you are being directed to turn into the street.
- ⑤ Arrow indicating direction of upcoming turn-off
- ⑥ Lane recommendation
- ⑦ If an arrow is displayed, a bar graph will also appear. The fewer bars are displayed, the shorter the distance to the turn-off point.

The following functions are available when route guidance is active:

- To have the last navigation cue repeated: Press the button.
- To adjust the volume of the navigation cues: Scroll the right thumbwheel up/down while a navigation cue is being played.

**! WARNING**

The route calculated by the navigation system is a recommendation of how best to reach a destination. Pay attention to traffic lights, no-stopping signs, lane change restrictions, one-way streets, etc.

**i Note**

- Also refer to ⇒ page 10, Controls at a glance.
- An exclamation mark “!” in front of the street name indicates that the navigation data of the MMI system do not contain all the information on this street or street section. Pay attention to traffic rules such as one-way streets or pedestrian zones.

**Head-up display**

Applies to: vehicles with head-up display



Fig. 20 Dashboard: Button for head-up display

The head-up display projects certain warnings and selected information from driver assist functions\* and the navigation system\* into the driver's area of vision.

**Switching on/off**

- To switch the head-up display on/off, press the button.

### Height adjustment

The height of the head-up display can be adjusted to your individual requirements.

- ▶ Sit in the correct position in your seat  
⇒ page 265.
- ▶ Turn the  button to adjust the display.

### Settings on infotainment system

- ▶ Select the following on the infotainment system: **MENU** button > **Car** > left control button > **Driver assist** > **Head-up display**.

### Display contents

The settings on the infotainment system allow you to specify which information is shown in the display. Possible options include navigation messages\*, adaptive cruise control\* and camera-based traffic sign recognition\*.

The display of certain information and some of the red warning lamps cannot be deactivated on the infotainment system.

### Brightness

You can adjust the brightness of the display via the infotainment system. In addition, the display brightness is reduced automatically as the daylight starts to fade. The basic level of brightness is determined by the instrument lighting setting  
⇒ page 53.

#### CAUTION

Do not place any objects over the opening for the head-up display to avoid scratching the glass cover.

#### Note

- The display may be harder to see in unfavourable light conditions or if you are wearing polarised sunglasses.
- To be able to see the display as clearly as possible, adjust the position of your seat and the height setting for the head-up display.
- Notes on cleaning ⇒ tab. *Cleaning the interior* on page 314.

## Warning and indicator lamps



### Description

The warning and indicator lamps light up or flash in the instrument cluster to indicate functions or faults.





Some of the warning and indicator lamps may be accompanied by a driver message. The warning display will be accompanied by the corresponding warning chime. The warning/indicator lamps and driver messages on the instrument cluster display can be masked by further displays. You can have them displayed again on the driver information system\* by calling up the second tab (driver messages) via the  button on the multi-function steering wheel. If several malfunctions have occurred, you can use the left thumbwheel to scroll through them on the display.

Some of the warning lamps may be displayed in different colours.

### Central warning/indicator lamps

If the warning/indicator lamp  or  lights up, observe the additional information on the instrument cluster display.

















Applies to: vehicles with monochrome display

If a driver message appears and a central warning lamp /central indicator lamp  lights up, the central warning/indicator lamp indicates the priority level of the warning. If a white indicator lamp also appears, the central warning/indicator lamp indicates its actual colour. For example, if  lights up with , read the description for .

### Overview

















When you switch on the ignition, some of the warning and indicator lamps light up briefly to show that the associated systems are working properly. These systems are marked with a ✓ in the following tables. If one of these warning/indicator lamps does not light up, there is a fault in the associated system. ▶





















**Red warning lamps**

|   |   |
|---|---|
|    | Central warning/indicator lamp<br>⇒ page 26,<br>Audi pre sense*<br>⇒ page 121 |
|    | Brake system ✓<br>⇒ page 29   |
|    | Electro-mechanical parking brake<br>⇒ page 30                                 |
|    | Cooling system<br>⇒ page 30   |
|    | Engine oil pressure<br>⇒ page 31  |
|    | Alternator<br>⇒ page 31   |
|    | Seat belt<br>⇒ page 31, ⇒ page 31   |
|   | Electro-mechanical power steering ✓<br>⇒ page 148                             |
|  | Steering lock<br>⇒ page 32  |
|  | Engine stopped while vehicle is moving<br>⇒ page 32                           |
|  | Gearbox<br>⇒ page 92  |
|  | Bonnet<br>⇒ page 33   |
|  | Adaptive cruise control*<br>⇒ page 113  |
|  | Emergency assist*<br>⇒ page 126   |
|  | AdBlue*<br>⇒ page 292   |
|  | AdBlue*<br>⇒ page 292   |

**Yellow indicator lamps**



















|   |   |
|---|---|
|  | Central warning/indicator lamp<br>⇒ page 26,<br>Brake servo*<br>⇒ page 29 |
|---|---|

|   |   |
|---|---|
|    | Electronic stabilisation control (ESC) ✓<br>⇒ page 33 |
|    | Electronic stabilisation control (ESC) ✓<br>⇒ page 33 |
| <b>ESC OFF</b>  | Electronic stabilisation control (ESC)<br>⇒ page 145  |
|    | Anti-lock brake system (ABS) ✓<br>⇒ page 33           |
|    | Safety systems ✓<br>⇒ page 31                         |
|    | Brake pads<br>⇒ page 33                               |
|    | Electro-mechanical parking brake<br>⇒ page 30         |
|    | Hill hold assist<br>⇒ page 33                         |
|  | Tyre pressure*<br>⇒ page 309                          |
| <b>TPMS</b>   | Tyre pressure*<br>⇒ page 309                          |
|  | Engine management*<br>⇒ page 33                       |
| <b>EPC</b>  | Engine management*<br>⇒ page 33                       |
|  | Engine management*<br>⇒ page 33                       |
|  | Emission control system ✓<br>⇒ page 33                |
|  | Diesel particulate filter*<br>⇒ page 34               |
|  | Engine speed governing*<br>⇒ page 34                  |
|  | Engine oil level (MIN)<br>⇒ page 34                   |
|  | Engine oil sensor<br>⇒ page 34                        |
|  | Engine warm-up requested*<br>⇒ page 34                |
|  | Battery charge<br>⇒ page 31                           |

|   |   |
|---|---|
|    | Fuel tank system<br>⇒ page 35   |
|    | Washer fluid level<br>⇒ page 35   |
|    | Windscreen wipers<br>⇒ page 35  |
|    | Remote control key*<br>⇒ page 77  |
|    | Driver's door*<br>⇒ page 35   |
|    | Battery in remote control key<br>⇒ page 38  |
|    | Bulb monitor*<br>⇒ page 35  |
|    | Headlight range control*<br>⇒ page 35   |
|    | Adaptive light*<br>⇒ page 35  |
|   | Light sensor/rain sensor*<br>⇒ page 36  |
|  | Gearbox (automatic gearbox)<br>⇒ page 92,<br>Clutch (manual gearbox)<br>⇒ page 32 |
|  | Steering lock<br>⇒ page 32  |
|  | Engine start system<br>⇒ page 32  |
|  | Electro-mechanical power steering<br>⇒ page 148                                   |
|  | Suspension control*<br>⇒ page 36  |
|  | Active lane assist*<br>⇒ page 124   |
|  | Side assist*<br>⇒ page 131  |
|  | Pre sense*<br>⇒ page 122  |
|  | AdBlue*<br>⇒ page 292   |
|  | AdBlue*<br>⇒ page 292   |

### Further indicator lamps

|   |   |
|---|---|
|    | Turn signals<br>⇒ page 36                     |
|    |   |
|    | Trailer turn signals*<br>⇒ page 36            |
|    | Rear seat belt* ✓<br>⇒ page 31                |
|    | Cruise control system*<br>⇒ page 104          |
|    | Speed limiter*<br>⇒ page 106                  |
|    | Adaptive cruise control*<br>⇒ page 113        |
|    | Adaptive cruise control*<br>⇒ page 113        |
|    | Adaptive cruise control*<br>⇒ page 113        |
|  | Adaptive cruise control*<br>⇒ page 114        |
|  | Active lane assist*<br>⇒ page 124             |
|  | Hold assist*<br>⇒ page 84                     |
|  | Start/stop system*<br>⇒ page 79               |
|  | Start/stop system*<br>⇒ page 79               |
|  | Convenience key*<br>⇒ page 79                 |
|  | Engine start system<br>⇒ page 32              |
|  | Gearbox<br>⇒ page 92                          |
|  | Electro-mechanical parking brake<br>⇒ page 30 |
|  | Electro-mechanical parking brake<br>⇒ page 30 |
|  | Hold assist*<br>⇒ page 84                     |

|   |  |
|---|--|
|    | Hill hold assist<br>⇒ page 33                        |
|    | Rear seat belt ✓<br>⇒ page 31                        |
|    | Rear seat belt ✓<br>⇒ page 31                        |
|    | Child lock (electric)*<br>⇒ page 46                  |
|    | AdBlue*<br>⇒ page 292                                |
|    | Rest recommendation*<br>⇒ page 110                   |
|    | Speed warning function*<br>⇒ page 104                |
|    | Cruise control system*<br>⇒ page 104                 |
| <b>LIM</b>  | Speed limiter*<br>⇒ page 106                         |
|  | Park assist*<br>⇒ page 139                           |
| <b>P OFF</b>  | Park assist*<br>⇒ page 139                           |
|  | Adaptive cruise control*<br>⇒ page 114               |
|  | Adaptive cruise control*<br>⇒ page 114               |
|  | Active lane assist*<br>⇒ page 124                    |
|  | Side assist*<br>⇒ page 131                           |
|  | Pre sense*<br>⇒ page 122                             |
|  | Camera-based traffic sign recognition*<br>⇒ page 108 |
|  | Main beam assist*<br>⇒ page 50                       |
|  |  |
|  | Main beam headlights<br>⇒ page 50                    |

## ⓘ Brake system

If the warning lamp lights up, there is a fault in the brake system.

### ⓘ Stop vehicle and check brake fluid level

Stop the vehicle and check the brake fluid level. Obtain professional assistance if necessary.

### ⓘ Warning! Brake servo inoperative!

You need to apply much more force to operate the brakes if the brake servo fails. Obtain professional assistance.

### ⓘ Brakes: fault. Safely stop vehicle

If the warning lamp lights up and the message appears, there is a fault in the brake servo.

If the ABS indicator lamp  and ESC indicator lamp  light up together with the brake warning lamp  and this driver message appears, the ABS, ESC and brake force distribution systems have failed ⇒ .

Do not drive on. Please seek professional assistance ⇒ .

### ⓘ Parking brake system fault! See owner's manual

- If the warning lamp and the message appear **after you switch on the ignition when the vehicle is stationary**, please check whether you can release the parking brake. If the parking brake cannot be released you should obtain professional assistance. If the parking brake can be released but the message still appears, drive to a qualified workshop without delay and have the fault rectified.
- If the warning lamp and the message appear **while driving**, there may be a malfunction in the parking brake auto release or the emergency brake functions. You may not be able to apply or release the parking brake. Do not park the car on a gradient. Obtain professional assistance.

### Brake servo: restricted. You can continue driving. Please contact workshop

There is a fault with the brake servo. The brake servo remains available with reduced capacity. ►

The brakes may perform differently than usual and the brake pedal may vibrate.

Drive to a qualified workshop without delay and have the fault rectified.

### **WARNING**

- Before opening the bonnet and checking the brake fluid level, observe the warning information on ⇒ *page 295, Working on components in the engine compartment.*
- If the brake warning lamp does not go out, or if it lights up when driving, the brake fluid level in the reservoir is too low - this may cause an increased accident risk. Stop the vehicle and do not drive on. Obtain professional assistance.
- If the brake warning lamp lights up together with the ABS indicator lamp and the ESC indicator lamp, this can mean that the control function of the ESC/ABS is not working. Input from the functions that stabilise the vehicle is no longer available. This could cause the tail of the vehicle to skid sideways. Do not drive on. Obtain professional assistance.

### **Electro-mechanical parking brake**

The warning lamp  lights up when the parking brake is applied.

If the warning lamp  flashes, insufficient braking force has been applied or released. Select first gear (manual gearbox) or position P (automatic gearbox) as an additional safeguard. Make sure that the warning lamp has gone out before you drive off.

#### **Parking brake!**

There is a malfunction in the parking brake. Drive to a qualified workshop soon and have the fault rectified.

#### **Parking brake auto release: unavailable**

If this message appears, press the brake pedal and then release the parking brake.

#### **Caution: Vehicle parked too steep**

If the warning lamp flashes and the message appears, the brake may not be strong enough to hold the vehicle. The brakes have overheated. The vehicle can roll away, even on a gentle slope.

#### **Parking brake is applied**

If this message appears, press the brake pedal and then release the parking brake as necessary.

#### **Note**

For further information on the parking brake refer to ⇒ *page 82.*

### **Cooling system**

#### **Switch off engine and check coolant level. See owner's manual**

The coolant level is too low.

Switch off the engine and do not drive on. Check the coolant level ⇒ *page 299.*

- If the coolant level is too low, add more coolant ⇒ *page 300.* Do not drive on until the warning lamp has gone out.

#### **Coolant temperature too high! Let engine run with vehicle stationary**

Let the engine cool down by running it at idling speed for a few minutes until the warning lamp goes out.

- Do not drive on if the warning lamp does not disappear. Obtain professional assistance.



### **WARNING**

- Never open the bonnet if you can see or hear steam or coolant escaping from the engine compartment; there is a risk of being scalded. Wait until you can no longer see or hear escaping steam or coolant.
- The engine compartment of any motor vehicle is a dangerous place. Before carrying out any work in the engine compartment, switch off the engine and allow it to cool down. Please observe the important safety warnings ⇒ *page 295, Working on components in the engine compartment.*



**! CAUTION**

Do not drive on if the warning lamp  lights up; otherwise there is a risk of engine damage.

** Engine oil pressure**** Switch off engine! Oil pressure too low**

Switch off the engine and do not drive on. Check the engine oil level ⇒ *page 298*.

- If the engine oil level is too low, add more oil ⇒ *page 297*. Do not drive on until the warning lamp has gone out.
- If the engine oil level is OK but the warning lamp still lights up, switch off the engine and do not drive on. Obtain professional assistance.

**i Note**

The oil pressure warning lamp is not an indicator for the oil level. The oil level should therefore be checked regularly.

** Alternator/vehicle battery**** Electrical system: fault. Battery is not being charged**

There is an alternator fault or a fault in the vehicle's electrical system.

Drive to a qualified workshop without delay. However, you should avoid using electrical equipment that is not absolutely necessary because this will drain the battery. If the battery charge is insufficient, obtain professional assistance.

** Electrical system: fault. Please contact workshop**

Drive to a qualified workshop without delay. Avoid using electrical equipment that is not absolutely necessary (such as the radio) because this will drain the battery. If the battery charge is insufficient, obtain professional assistance.

** Electrical system: low battery charge. Battery will be charged while driving**

Starting reliability may be impaired.

If this message disappears after a while, the vehicle battery will have been sufficiently charged while driving.

If the message does not disappear again, drive to a qualified workshop without delay and have the fault rectified.

** Safety systems**

The indicator lamp  monitors the safety systems.

If the indicator lamp  lights up or flashes, there is a malfunction in one of the safety systems.

Drive to a qualified workshop without delay and have the fault rectified.

** WARNING**

Have the safety systems examined without delay; otherwise they may fail to trigger in an accident – this could result in serious or possibly fatal injury.

** Front seat belt**

The warning lamp  lights up and does not go out until the driver's and front passenger's\* seat belts have been fastened. When the vehicle has gathered speed you will also hear a warning chime.

**i Note**



For further information on the seat belts ⇒ *page 275*.



** Rear seat belt**

Applies to: vehicles with seat belt warning system (rear seats)

If a rear seat belt is buckled/unbuckled, the corresponding indicator lamp lights up briefly.

 - If the indicator lamp lights up briefly, the corresponding rear seat is not occupied.

 /  - If the indicator lamp lights up briefly, the rear seat belt has been fastened.

 /  - If the warning lamp flashes, the seat belt has been unbuckled with the vehicle moving. ►

When the vehicle has gathered speed you will also hear a warning chime.

### Note

For further information on the seat belts  
⇒ page 275.

## Steering lock

### Do not drive vehicle: steering defective

There is a malfunction in the electronic steering lock. The ignition can no longer be switched on.

**Do not** have the vehicle towed away, because you won't be able to steer it. Obtain professional assistance.

### Steering lock: system fault! Please contact workshop

There is a malfunction in the electronic steering lock.

Drive to a qualified workshop soon and have the fault rectified.

### WARNING

Your vehicle must not be towed if there is a fault in the electronic steering lock - risk of accident!

## Engine start system

### Engine start system: system fault! Please contact workshop

Do **not** switch off the ignition; otherwise you may not be able to switch it on again.

Drive to a qualified workshop without delay and have the fault rectified.

### Engine start system: system fault! Please contact workshop

There is a malfunction in the engine start system.

Drive to a qualified workshop soon and have the fault rectified.

## Clutch

Applies to: vehicles with manual gearbox

### Clutch: fault. Please contact workshop

There is a permanent malfunction in the clutch. The transmissible torque is reduced. You can continue driving, but avoid placing an excessive load on the clutch. Do not slip the clutch for too long, for example when driving away on a slope, towing a trailer or when parking. Drive to a qualified workshop soon and have the fault rectified.

### Clutch: overheating. Please adapt driving style

There is a malfunction in the clutch. The transmissible torque is reduced. You can continue driving, but avoid placing an excessive load on the clutch. Do not slip the clutch for too long, for example when driving away on a slope, towing a trailer or when parking. The indicator lamp will go out when the transmission capability of the clutch has been restored completely.

## Engine stopped while vehicle is moving

### Engine stopped: brake servo and power steering not possible

There is a malfunction in the engine or fuel supply system.

Greater strength is required to steer and brake the vehicle if the engine stops while the vehicle is coasting. Carefully try to bring the coasting vehicle safely to a standstill out of the way of moving traffic. Obtain professional assistance.

### WARNING

Greater strength is required to brake the vehicle if the engine stops while the vehicle is moving - risk of accident! Greater strength will be required to steer the vehicle unless the power steering is still providing assistance. The power steering may still be available if the vehicle is still coasting with the ignition switched on (and the vehicle battery charge is sufficient).

## Bonnet

### **Warning! Bonnet not locked. Stop vehicle and check bonnet lock**



If the warning lamp lights up and the message appears, the bonnet lock is not correctly engaged.

Stop your vehicle without delay and close the bonnet ⇒ *page 296*.



## Electronic stabilisation control (ESC)

If the indicator lamp  flashes while the vehicle is in motion, the ESC or traction control system (ASR) is intervening.

If the indicator lamp  lights up, the ESC system has been switched off for system reasons. In this case, the ESC can be reactivated by switching the ignition off and then on again. If the indicator lamp goes out, this means the system is fully functional.

If the indicator lamp  lights up, the ESC system has been partially or completely switched off via the  button ⇒ *page 145*.

### **Stabilisation control (ESC/ABS): fault! See owner's manual**

If the indicator lamp  and the ABS indicator lamp  light up and the message appears, there is a malfunction in the anti-lock brake system or electronic differential lock. This will also cause an ESC malfunction. The vehicle can still be braked in the normal way (however the ABS control function will be out of action).

Drive to a qualified workshop without delay and have the fault rectified.

### **Note**

For more information about the ESC and ABS systems, refer to ⇒ *page 145*.

## Brake pads

### **Brake pads!**

The brake pads are worn.

Drive to a qualified workshop without delay and have the brake pads checked.

## Hill hold assist

### **Hill hold assist: unavailable**

If this message appears, the hill hold assist is unavailable.

### **Manual control!**

If this message appears, press the brake pedal. Use the parking brake for the hill start ⇒ *page 82*.

## Engine management

### **Drive system: fault. Please contact workshop**

If the indicator lamp  lights up, there is a fault in the engine management system.

Drive slowly to a qualified workshop without delay and have the engine checked.

## **EPC Engine management**

Applies to: vehicles with petrol engine

If the indicator lamp  lights up, there is a fault in the engine management system.

Drive slowly to a qualified workshop without delay and have the engine checked.

## Engine management

Applies to: vehicles with diesel engine

If the indicator lamp  lights up when the ignition is switched on, the glow plugs are preheating.

If the indicator lamp does not light up or if it flashes while the vehicle is moving, there is a fault in the engine management system.

Drive slowly to a qualified workshop without delay and have the fault rectified.

## Emission control system

If the indicator lamp  lights up or flashes, a fault has occurred which can reduce the quality of ▶

the exhaust gas and damage the catalytic converter.

Drive slowly to a qualified workshop without delay and have the fault rectified.

### Diesel particulate filter

Applies to: vehicles with diesel particulate filter

### Particulate filter: system fault. See owner's manual

The diesel particulate filter requires regeneration. You can assist the self-cleaning function of the filter by driving as follows:

Drive at a speed of at least 60 km/h for about 15 minutes in 4th or 5th gear (on vehicles with manual gearbox), or with the selector lever in position S (on vehicles with automatic gearbox). Keep the engine speed at about 2000 rpm. As a result of the increase in temperature, the soot in the filter will be burned off. The indicator lamp will go out once the cleaning process has been completed successfully.

If the indicator lamp does **not** go out, drive to a qualified workshop without delay and have the fault rectified.

### WARNING

It is essential that you adjust your speed to suit the weather, road, terrain and traffic conditions. The recommended driving speed must never lead to the driver disregarding the traffic regulations.

### Note

For more information about the diesel particulate filter, refer to ⇒ *page 295*.

### Engine speed governing

Applies to: vehicles with engine speed governing

### Max. engine speed: XXXX rpm

The engine speed will automatically be governed to the speed displayed in the instrument cluster. This protects the engine from overheating.

The rev limiter is deactivated as soon as the engine temperature is no longer within the critical

range and you have taken your foot off the accelerator.

If the rev limiter has been activated because of a fault in the engine management system, the indicator lamp  or **EPC** will also light up. Make sure that the engine speed does not exceed the speed displayed in the driver information system, for example when shifting down a gear. Drive to a qualified workshop without delay and have the fault rectified.

### Engine oil level (MIN)

#### Please check oil level

You can continue driving for the time being but you should check the engine oil level as soon as possible ⇒ *page 297*.

- If the engine oil level is too low, add more oil ⇒ *page 298, Checking and topping up the engine oil level*.
- If the engine oil level is normal but the indicator lamp stays on, drive to a qualified workshop without delay and avoid high engine speeds.

### Engine oil sensor

#### Oil level sensor: system fault

The sensor for checking the engine oil level has failed. Drive to a qualified workshop soon and have the fault rectified.

#### Oil level sensor: oil change required. Please contact workshop

The engine oil level is too high.

Drive to a qualified workshop without delay and have the fault rectified.

### CAUTION

Please observe the procedure described in the Owner's Manual ⇒ *page 298, Checking and topping up the engine oil level*.

### Engine warm-up requested\*

#### Please warm up engine

Fuel has entered the engine oil due to low outside temperatures or frequent short trips. Drive until the engine is warm to allow the fuel to evaporate out of the engine oil. When doing so, avoid high engine speeds, full acceleration and heavy engine loads.

### Fuel tank system

#### Please refuel

When the indicator lamp lights up for the first time and the message appears, there are still about 7 litres (front-wheel drive) or about 8.5 litres (four-wheel drive) of fuel left in the tank.

#### Please refuel immediately

If the indicator lamp lights up and the message appears, the fuel tank is almost empty. Drive to a filling station without delay.

#### Tank system malfunction! Please contact workshop

There is a malfunction in the tank system.

Drive to a qualified workshop without delay and have the fault rectified.

#### Note

For more information about filling the tank, refer to [⇒ page 290](#).

### Washer fluid level

#### Please add washer fluid

With the ignition switched off, top up the fluid for the windscreen washer and headlight washer system\* [⇒ page 303](#).

### Windscreen wipers

#### Windscreen wiper defective

There is a malfunction in the windscreen wipers.

Drive to a qualified workshop without delay and have the fault rectified.

### Driver's door\*

#### Driver's door: fault. Shift to P before leaving vehicle. See owner's manual

A malfunction has occurred in the driver's door. Move the selector lever to position P (automatic gearbox) to hold the vehicle.

Drive to a qualified workshop soon and have the fault rectified.

### Bulb monitor

If the indicator lamp  lights up, a bulb has failed. The message indicates the location of the bulb.

Have the bulb replaced without delay.

#### Vehicle lights: malfunction!

There is a fault with the headlights or light switch. Drive to a qualified workshop soon and have the fault rectified.

#### WARNING

Bulbs are sensitive to pressure. The glass can break when you touch the bulb, causing injury.

### Dynamic headlight range control

Applies to: vehicles with dynamic headlight range control

#### Headlight range control: system fault!

There is a malfunction in the dynamic headlight range control which may cause other road users to be dazzled.

Drive to a qualified workshop without delay and have the fault rectified.

### Audi adaptive light

Applies to: vehicles with Audi adaptive light

#### Audi adaptive light: system fault!

There is a malfunction in the adaptive light. The dipped beam headlights will still be working normally.

Drive to a qualified workshop soon and have the fault rectified.

### Light sensor/rain sensor

Applies to: vehicles with light sensor/rain sensor

#### Automatic headlights/wipers: system fault!

The light sensor/rain sensor is out of action.

For safety reasons, the dipped beam headlights will then be switched on permanently when the light switch is set to the **AUTO** position. You can still switch the lights on and off in the normal way with the light switch. You can also continue to use all the other wiper functions that do not use the rain sensor.

Drive to a qualified workshop soon and have the fault rectified.

### Suspension control



Applies to: vehicles with suspension control

#### Suspension: system fault!

There is a malfunction in the suspension control system.

Drive to a qualified workshop soon and have the fault rectified.

### Turn signals

If the indicator lamp  or  flashes, the turn signals are on. If both indicator lamps flash, the hazard warning lights are on.

If one of the indicator lamps flashes twice as fast as usual, a turn signal bulb has failed. Drive carefully to a qualified workshop without delay and have the fault rectified.

### Trailer turn signals

Applies to: vehicles with towing bracket

If the indicator lamp  flashes, the turn signals are on in towing mode.

If a turn signal bulb on the trailer or vehicle fails in towing mode, the indicator lamp does **not** flash twice as fast to indicate the bulb failure.

## Doors and windows

### Central locking system

#### Description

The vehicle can be locked and unlocked via the central locking system. You can use any of the following:

- Remote control key ⇒ *page 39*, or
- Sensors in the front door handles\* ⇒ *page 39*, or
- Lock on driver's door ⇒ *page 41*
- Interior central locking switch ⇒ *page 40*

#### Turn signals

The turn signals will flash twice when the vehicle is unlocked and once when the vehicle is locked.

If the turn signals do not flash, the ignition may still be on or one of the doors, the bonnet or the boot lid may still be open.

#### Automatic locking function (Auto Lock)

The Auto Lock function locks the doors and the boot lid when the vehicle exceeds a speed of about 15 km/h.

The vehicle is unlocked again immediately when the ignition key is removed, the unlock button on the central locking switch is pressed or one of the interior door handles is pulled. The Auto Lock function can be switched on and off in the infotainment system ⇒ *page 41*.

In the event of an accident in which the airbags inflate, the doors will be automatically unlocked to facilitate access and assistance.

#### Selecting which doors are unlocked with the remote control

When you lock the vehicle, the central locking system will lock the doors and the boot lid. When you unlock the vehicle, the central locking system will unlock either the driver's door *only*, or all the locks on the vehicle, depending on the setting you have selected on the infotainment system ⇒ *page 41*.

#### Accidental lock-out

To prevent yourself from being locked out, only lock the vehicle when the remote control key is not in the vehicle and all of the doors and the boot lid are closed.

The central locking system prevents you from being locked out of the vehicle in the following situations:

- When the driver's door is open, you cannot lock the vehicle by pressing the  button on the remote control key or touching the locking sensor\* on one of the doors.
- The boot lid will be released again automatically if the convenience key\* that was last in use is left inside the boot when the boot lid is closed.
- If the convenience key\* that was last in use is detected in the vehicle, it is not possible to lock the vehicle from the outside.



#### WARNING

- Always take the key with you when leaving the vehicle - even if you only intend to be gone for a short time. This is especially important if children are left in the car. They might otherwise be able to start the engine or use power-operated equipment such as the electric windows - this could lead to injuries.
- Locked doors could delay assistance in an emergency, potentially putting lives at risk. Do not leave anyone (especially children) in the vehicle.



#### Note

- Never leave any valuable items in the vehicle unattended. Even a locked vehicle is not a safe.
- When you lock the vehicle, the LED on the driver's window sill flashes. If the LED is still on about 30 seconds after the vehicle is locked, the central locking system is not working properly. You should have the malfunction repaired by a qualified workshop.

**Set of keys**



Fig. 21 Keys supplied with the vehicle

**Remote control keys**

The remote control key can be used to lock and unlock the car. Press the release button ⇒ Fig. 21 -arrow- to make the key spring out of the handle and to fold it back in.

**Number of keys**

You can check how many keys are initialised for your vehicle using the infotainment system. To do so, select: **MENU** button > **Car** > left control button > **Servicing & checks** > **Car information**. This feature enables used car buyers to make sure they have received all of the keys.

**Replacing a key**

If you should lose a key, please contact an Audi dealer. Have the remote control coding for *that* key deactivated. For this purpose you should bring all available keys with you. It is also important to notify your insurance company if a key has been lost.

**Electronic immobiliser**

The immobiliser is designed to prevent unauthorised persons from driving the vehicle. It may not be possible to start the engine with the key if there is another ignition key from a different make of vehicle on the same key ring.

**Data stored on remote control key**

Data related to the service and maintenance of the vehicle are stored continuously on your remote control key. Your Audi dealer can read out the data and will then be able to tell you what

service work is required. This also applies to vehicles with convenience key\*.



**Note**

The function of the remote control key may be impaired by interference from other nearby radio signals (for example from a mobile telephone or TV transmitter) if these are in the same frequency range.

**LED and battery for the remote control key**



Fig. 22 Remote control key (rear): Opening the cover

**LED on remote control key**

The LED on the remote control key lights up when you press the buttons.

- ▶ The LED should flash once when you press one of the buttons briefly.
- ▶ The LED should flash repeatedly when you press and hold one of the buttons (convenience open/close).
- ▶ If the LED does not flash, the battery in the remote control key is flat. In addition, the indicator lamp will light up and the message **Remote control key: please change key battery** will appear. Replace the battery in the remote control key.

**Replacing the battery for the remote control key**

- ▶ Use a coin to lever the cover ② off the key ① ⇒ Fig. 22.
- ▶ Insert the new battery with the “+” symbol facing up.
- ▶ Press the cover back onto the key until it clicks into place.



**For the sake of the environment**

Used batteries must be disposed of appropriately and must not be discarded with ordinary household waste.

**Note**

The new battery must be of the same type as the original one in the remote control key.

**Re-synchronising the remote control key**

If the remote control key fails to lock/unlock the vehicle, it will be necessary to re-synchronise the system.

- ▶ Press the button on the remote control.
- ▶ Unlock the driver's door within 30 seconds by turning the key in the lock ⇒ *page 41*.
- ▶ Press button or .

**Locking and unlocking the vehicle with the remote control key**

Fig. 23 Remote control key/convenience key\*: Buttons

- ▶ To unlock the vehicle, press button ⇒ *Fig. 23*.
- ▶ To lock the vehicle, press button **once** ⇒ .
- ▶ To unlock the luggage lid, press button briefly.
- ▶ To open\* the boot lid, press and hold button for at least one second.

The vehicle will be locked again automatically if you do not open one of the doors or the boot lid within 45 seconds after unlocking the car. This function prevents the vehicle from remaining unlocked if the unlock button is pressed by mistake.

This does not apply if you press and hold button for one second or longer.

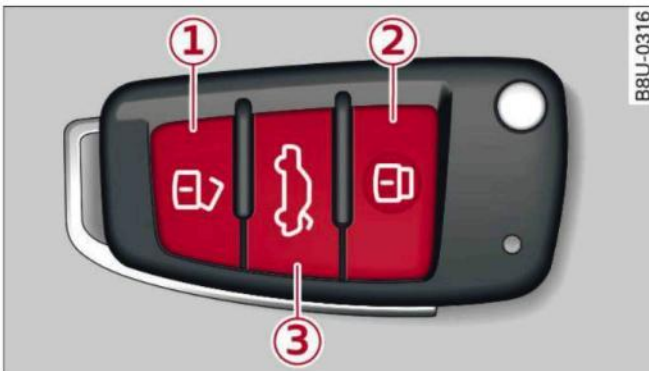
When you unlock the vehicle, the central locking system will unlock either the entire vehicle or the driver's door only, depending on the setting you have selected on the infotainment system ⇒ *page 41*.

**WARNING**

- Read and follow all the warnings ⇒ in *Description on page 37*.
- Applies to vehicles with anti-theft alarm system: Do not leave anyone (especially children) in the car if it is locked from the outside and the safelock mechanism\* is activated: the doors and windows cannot then be opened from the inside ⇒ *page 42*. Locked doors could delay assistance in an emergency, potentially putting lives at risk.

**Note**

- Do not use the remote control key when the vehicle is out of sight.
- Applies to automatic gearbox: The vehicle can only be locked when the selector lever is in position P.

**Locking and unlocking the vehicle with the convenience key**

Applies to: vehicles with convenience key

*The doors and the boot lid can be locked and unlocked without handling the remote control key.*

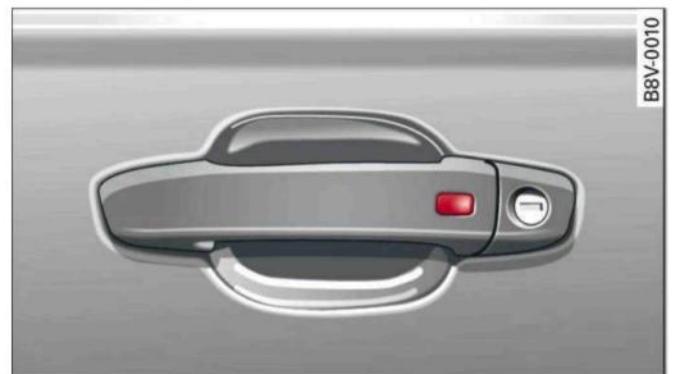

Fig. 24 Driver's door: Locking vehicle with convenience key ▶

### Unlocking the vehicle

- ▶ Take hold of the driver's/front passenger's door handle. The door will be unlocked automatically.
- ▶ To open the door, pull the door handle.

### Locking the vehicle

- ▶ Automatic gearbox: Move the selector lever to position P; otherwise it will not be possible to lock the vehicle.
- ▶ To lock the vehicle, close the door and touch the sensor on the door handle **once** ⇒ Fig. 24, ⇒ ⚠. Do not take hold of the door handle while doing so.

The vehicle can be locked/unlocked from the front doors only. The remote control key should be within a range of about 1.5 metres from the door handle. It does not matter where you carry the key, for instance whether it is in your jacket pocket or in a handbag or briefcase.

The locking function may be affected if you grasp the door handle while the vehicle is being locked.

Once the doors have been locked, they cannot be opened again immediately. This will enable you to check that the driver's door is properly closed.

The system will unlock either all the doors or only one of the doors, depending on the settings you have chosen on the infotainment system ⇒ page 41.

#### ⚠ WARNING

- Read and follow all the warnings ⇒ ⚠ in Description on page 37.
- Applies to vehicles with anti-theft alarm system: Do not leave anyone (especially children) in the car if it is locked from the outside and the safelock mechanism\* is activated: the doors and windows cannot then be opened from the inside ⇒ page 42. Locked doors could delay assistance in an emergency, potentially putting lives at risk.

#### ℹ Note



Please note the following points if the vehicle is left parked for long periods:

- To save electrical power, the proximity sensors are switched off after a few days. You will then need to pull the door handle once to unlock the vehicle, and a second time to open it.
- To prevent the vehicle battery from becoming discharged and thus maintain the vehicle's starting ability for as long as possible, the power management system will gradually switch off convenience functions that are not required. In this case you may not be able to unlock the vehicle with this convenience function.

### Central locking switch



Fig. 25 Driver's door: Central locking switch

- ▶ To lock the vehicle, press the  button ⇒ ⚠.
- ▶ To unlock the vehicle, press the  button ⇒ Fig. 25.

Please note the following when you use the central locking switch to lock your vehicle:

- The doors and the boot lid cannot be opened from the *outside* (for safety reasons, when stopped at traffic lights, etc.).
- The LED in the central locking switch lights up when all of the doors are closed and locked.
- You can open the doors individually from the inside by pulling the inside door handle.
- In the event of an accident in which the airbags inflate, doors locked from the inside will be automatically unlocked to facilitate access and assistance.

#### ⚠ WARNING

- Read and follow all the warnings ⇒ ⚠ in Description on page 37.

- The central locking switch is still operative when the ignition is switched off and will automatically lock the entire vehicle when the  button is pressed.
- The central locking switch inside the vehicle is not operative if you lock the vehicle from the outside.

### Note

The doors and the boot lid are locked automatically when the vehicle reaches a speed of about 15 km/h (Auto Lock) ⇒ *page 37*. You can unlock the vehicle again via the  button in the central locking switch.

### Adjusting the settings for the central locking system

You can use the infotainment system to select which functions are controlled via the central locking system.

- ▶ Select the following on the infotainment system: **[MENU]** button > **Car** > left control button > **Vehicle settings** > **Central locking**.

**Doors to unlock** - You can select whether **all** doors or only the **driver's door** are unlocked by the central locking system. The boot lid will also be unlocked if you select **all**. If you select **driver's door** on vehicles with convenience key\*, only one door will be unlocked (whichever door you grip by the handle).

When the **driver's door** setting is activated, you can still unlock all the doors and the boot lid by pressing the  button on the remote control key twice.

**Long press to open windows** - The convenience open/close function can be activated/deactivated ⇒ *page 47*.

**Lock when driving**<sup>1)</sup> - If you activate this function, the whole vehicle is locked automatically when you are driving.

**Fold mirrors\*** - If you activate this function, the exterior mirrors are folded in automatically when the vehicle is locked.

### Locking and unlocking the doors manually







Fig. 26 Driver's door lock



Fig. 27 End face of (open) door: Locking manually

If the central locking system should fail to work, the doors must be locked/unlocked separately.

### Locking and unlocking the driver's door

- ▶ To unlock the driver's door, turn the key to the unlock position  ⇒ *Fig. 26* ⇒ .
- ▶ To lock the driver's door, move the selector lever to position P (automatic gearbox) and turn the key to the lock position  **once** ⇒ .

Applies to vehicles with anti-theft alarm system: Switch on the ignition or press the  button on the remote control key after opening the driver's door. Otherwise the alarm will be triggered.

The system will unlock either all the doors or only one of the doors, depending on the settings you have chosen on the infotainment system ⇒ *page 41*.

<sup>1)</sup> This function is not available on all export versions.

### Locking the passenger's door/rear doors

The mechanical locking device is located on the end face of the front passenger's door and the rear doors. It is only visible when the door is open.

- ▶ Pull the cap out of the opening ⇒ Fig. 27.
- ▶ Insert the key in the slot inside and turn it as far as the stop to the right (if the door is on the right side) or to the left (if the door is on the left side).

#### WARNING

- Read and follow all the warnings ⇒  in Description on page 37.
- Applies to vehicles with anti-theft alarm system: Do not leave anyone (especially children) in the car if it is locked from the outside and the safelock mechanism\* is activated: the doors and windows cannot then be opened from the inside ⇒ page 42. Locked doors could delay assistance in an emergency, potentially putting lives at risk.

#### CAUTION

Ensure that you only insert the the key in the lock in the direction illustrated to avoid damaging the key and the lock ⇒ Fig. 26. On right-hand drive vehicles, the key should be inserted the other way around correspondingly.

### Anti-theft alarm system

Applies to: vehicles with anti-theft alarm system



Fig. 28 End face of (open) driver's door: Button for interior monitor/tow-away protection

If the anti-theft alarm system senses interference with the vehicle it triggers an audible and visible alarm. The anti-theft alarm system is activated when you lock the vehicle in the usual way and is switched off again when you unlock the vehicle.

The anti-theft alarm system comprises the following components:

#### Anti-theft alarm

The alarm is triggered if the bonnet, the boot lid or any of the doors are forced open. The alarm system is armed whenever the vehicle is locked.

If you unlock the vehicle by turning the key in the driver's door lock, you should switch on the ignition within 15 seconds to prevent the alarm from being triggered. On some export versions, the alarm is triggered immediately when you open a door.

To deactivate the alarm, switch on the ignition or press the  button on the remote control key.

#### Interior monitor and tow-away protection

When the vehicle is locked, the alarm will be triggered if movements are detected in the interior (e.g. by animals) or if the vehicle's inclination is changed (e.g. during transport). You can prevent the alarm from being triggered accidentally by switching off the interior monitor and/or tow-away protection. To do so, proceed as follows:

- ▶ Press the  button ⇒ Fig. 28. The LED in the button will light up.
- ▶ If you now lock the vehicle, the interior monitor and tow-away protection will remain deactivated until the vehicle is unlocked again.

#### Safelock<sup>1)</sup>

The doors can no longer be opened from the inside. This makes it more difficult to break into the vehicle ⇒ . The message **Be aware of door safelock. See owner's manual** appears on the instrument cluster display when you switch off the ignition as a reminder that the safelock mechanism\* will be activated. You can switch off the

<sup>1)</sup> This function is not available on all export versions/equipment versions.

safelock mechanism\* by using one of the following options:

- ▶ Press the  button on the remote control key a second time **within 2 seconds**. Or:
- ▶ Applies to vehicles with convenience key: Touch the sensor on the door handle a second time **within 2 seconds**. Or:
- ▶ Turn the key in the door lock to the lock position a second time **within 2 seconds**.

The alarm is triggered if you switch off the safelock mechanism\* and a door handle is then operated. To deactivate the alarm, switch on the ignition or press the  button on the remote control key.

### WARNING

Do not leave anyone (especially children) in the car if it is locked from the outside and the safelock mechanism\* is activated: the doors and windows cannot then be opened from the inside. Locked doors could delay assistance in an emergency, potentially putting lives at risk.

### CAUTION

If you switch off the safelock mechanism\*, the interior monitor and tow-away protection are automatically disabled, and vice versa. This means that your vehicle is no longer completely protected against theft.

### Note

The interior monitor and tow-away protection will only function as intended if the windows and the panorama sun roof\* are closed.

## Boot lid

### Opening/closing boot lid



Fig. 29 Boot lid: Opening (release catch)

### Opening boot lid

- ▶ Press the  button on the remote control key for at least one second, or
- ▶ Press the release catch on the boot lid  
⇒ Fig. 29.

### Closing boot lid

- ▶ Pull down the boot lid by the handle on the inside and let it drop into the latch ⇒ .

### WARNING

- After closing the boot lid, always check that the catch has engaged properly. The boot lid could otherwise open suddenly when the vehicle is moving - this could result in an accident.
- The boot lid must always be completely closed when the vehicle is moving; otherwise toxic exhaust fumes can be drawn into the interior.
- Always make sure that no-one is in the boot lid's area of movement (especially near the hinges) when it is moving. Risk of severe injuries to fingers or hands!

### Note

When the vehicle is locked, you can unlock the boot lid separately by pressing the  button on the remote control key. The boot lid will lock automatically when you close it again.

### Power-operated boot lid

Applies to: vehicles with power-operated boot lid

*The boot lid can be opened and closed automatically.*



Fig. 30 Driver's door: Opening boot lid

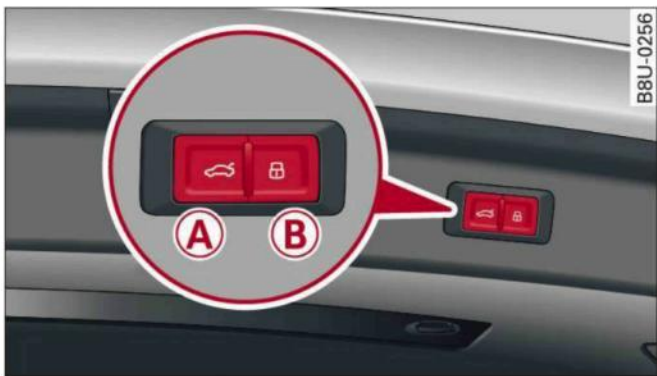

Fig. 31 Boot lid: (A) close button, (B) lock button (vehicles with convenience key\*)

### Opening boot lid

- ▶ To unlock the boot lid, briefly press the button on the remote control key. Or:
- ▶ To unlock the boot lid, press the release catch on the boot lid (vehicles with convenience key\*). The boot lid will be unlocked if an authorised remote control key is detected near the vehicle. Or:
- ▶ Briefly pull the button in the driver's door ⇒ Fig. 30. Or:
- ▶ To open the boot lid, press the button on the remote control key for at least one second. Or:
- ▶ Press the release catch on the boot lid.

### Closing boot lid

- ▶ Pull and hold the switch in the driver's door until the boot lid is closed ⇒ . Or:
- ▶ Press the button inside the boot lid ⇒ Fig. 31. The boot lid will move down and close automatically ⇒ . Or:

- ▶ Press and hold the button on the remote control key (on vehicles with convenience key\*) until the boot lid starts to close ⇒ . Make sure to stand clear of the boot lid when doing so. The distance from the rear of the vehicle should be not more than 1.5 metres. Or:
- ▶ Press the button inside the boot lid ⇒ Fig. 31 (vehicles with convenience key\*) ⇒ . The remote control key should be within a range of about 1.5 metres from the luggage compartment and should not be inside the vehicle. The boot lid will move down and close automatically. The vehicle will be locked.

### Interrupting the opening/closing operation

- ▶ Pull/release the button in the driver's door. Or:
- ▶ Press the button on the remote control key (on vehicles with convenience key\*). Or:
- ▶ Press the or button (vehicles with convenience key\*) inside the boot lid. Or:
- ▶ Press the release catch on the boot lid. Or:
- ▶ Press the boot lid against the direction of movement with your hands.
- ▶ To continue opening/closing the boot lid after interrupting the procedure, press the catch or one of the buttons or (vehicles with convenience key\*).

The boot lid also stops moving if it cannot open/close freely or if it is obstructed.

### Storing the open position

- ▶ Open the boot lid as far as desired. The boot lid must be opened at least as far as the minimum open setting, otherwise it will not be possible to store the setting.
- ▶ Press the button for at least four seconds to store the desired open position. A visual and audible signal will be given.
- ▶ To set a higher open position, wait for five seconds and then push the boot lid carefully upwards.
- ▶ Then press the button for at least four seconds again to store the desired open position. ▶

### WARNING

- After closing the boot lid, always check that the catch has engaged properly. The boot lid could otherwise open suddenly when the vehicle is moving - this could result in an accident.
- Always make sure that no-one is in the boot lid's area of movement (especially near the hinges) when it is moving. Risk of severe injuries to fingers or hands!
- The boot lid must always be completely closed when the vehicle is moving; otherwise toxic exhaust fumes can be drawn into the interior.
- If a luggage rack (e.g. a bicycle carrier) is attached to the boot lid, the boot lid may not open completely or may move downwards by itself due to the added weight. For this reason, make sure you support the boot lid or take the luggage off the carrier before opening the boot lid - risk of injury!

### Note

- When towing a trailer\* the automatic open function can only be operated via the release catch on the boot lid.
- If the battery is low, the boot lid can still be opened and closed manually; however, this will require more effort. If you move the boot lid slowly less effort will be required.
- When the vehicle is locked, you can unlock the boot lid separately by pressing the  button on the remote control key. The boot lid will lock automatically when you close it again.

### Releasing boot lid manually from inside

Applies to: vehicles with manual release on inside

*The boot lid can be released manually from the inside.*



**Fig. 32** Detail of inside of boot lid: Access to manual release

- ▶ Fold the rear seat backrest forwards  
⇒ *page 63*.
- ▶ Use the blade of the ignition key to prise off the cover ① ⇒ *Fig. 32*.
- ▶ Insert the key in the opening behind the cover ② and press the key in the direction of the arrow until the boot is unlocked.

## Child locks

Applies to: vehicles with electric/mechanical child lock

The child locks disable the rear windows and prevent the rear doors from being opened from the inside.





Fig. 33 Detail of the driver's door: Controls



Fig. 34 Rear door: Child lock

### Vehicles with button

- ▶ To activate/deactivate the interior door handle and electric window switch on each of the rear doors, press the left/right button  on the driver's door ① ⇒ Fig. 33. The LED in the button will light up or go out.
- ▶ To activate/deactivate the child locks on both sides, press the  buttons one after the other.

### Vehicles with button

- ▶ To activate/deactivate the electric window switches on the rear doors, press the  button on the driver's door ② ⇒ Fig. 33. The LED in the button will light up or go out.
- ▶ To activate/deactivate the interior door handle in addition, open the corresponding rear door and use the car key to turn the key-operated switch in the direction of the arrow (or in the opposite direction) ⇒ Fig. 34.

## Driver message in the instrument cluster display

### Child lock: fault. Please contact workshop

There is a malfunction in the child lock. Press the  button again.

If the message remains displayed, drive to a qualified workshop soon and have the fault rectified.

### WARNING

- Always take the key with you when leaving the vehicle - even if you only intend to be gone for a short time. This is especially important if children are left in the car. They might otherwise be able to start the engine or use power-operated equipment such as the electric windows - this could lead to injuries.
- If there is a malfunction in the child lock, it may be possible to open the rear doors from the inside - risk of accident!

## Electric windows

### Controls

The driver can operate all the electric windows.

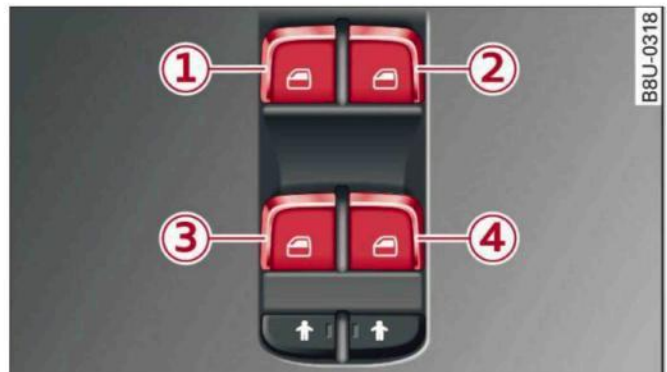

Fig. 35 Driver's door: Controls for electric windows (example)

All electric windows have two-stage switches:

### Opening/closing the windows

- ▶ Press/pull the switch briefly to the second stop: the window will automatically open/close all the way. The window will stop moving immediately if the switch is operated again. ▶



- ▶ To set an intermediate position, press/pull the switch to the first position until the window has reached the desired position.

### Switches for electric windows

- ① Front left
- ② Front right
- ③ Rear left
- ④ Rear right

#### WARNING

- Always take the key with you when leaving the vehicle - even if you only intend to be gone for a short time. This is especially important if children are left in the car. They might otherwise be able to start the engine or use power-operated equipment such as the electric windows - this could lead to injuries.
- Always be careful when closing the windows. Careless use of the electric windows can cause severe injuries.
- When locking the vehicle from the outside, make sure that nobody is inside the vehicle, as the windows cannot be opened from the inside in an emergency.

#### Note

The windows can be operated for about ten minutes after the ignition has been switched off. The window switches are only deactivated when the driver's door or the front passenger's door is opened.

### Convenience open/close function



Applies to: vehicles with convenience open/close function

*All the windows and the panorama sun roof\* can be opened and closed together.*

### Convenience open function



- ▶ Press and hold the  button on the remote control key until all the windows and the panorama sun roof\* have reached the desired position.

### Convenience close function

- ▶ Press and hold the  button on the remote control key until all the windows and the panorama sun roof\* are closed ⇒ . Or:
- ▶ Applies to vehicles with convenience key: Touch and keep your hand in contact with the sensor on one of the front door handles until all the windows and the panorama sun roof\* are closed. Do not rest your hand on the door handle while this is happening.

This function can be switched on/off via the infotainment system ⇒ *page 41*.

#### WARNING

- Take care when closing the windows and the panorama sun roof\*. Careless or uncontrolled use can cause injuries.
- For safety reasons, you should only use the remote control key to open and close the windows and panorama sun roof\* within about 2 metres of the vehicle. To avoid injuries, always keep an eye on the windows and the panorama sun roof\* when pressing the  button to close them. The windows and sun roof stop moving as soon as the  button is released.

### What to do after a malfunction

*You can reactivate the one-touch open and close function if it fails to operate.*

- ▶ Pull and hold the electric window switch until the window is fully closed.
- ▶ Release the switch and then pull it again for at least one second.

## Panorama sun roof

### Description

Applies to: vehicles with panorama sun roof

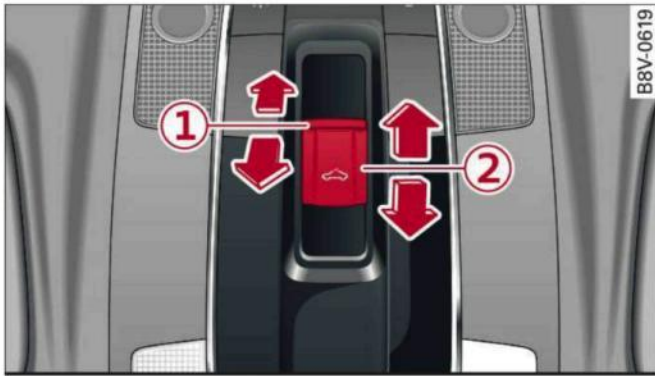

Fig. 36 Detail of headliner: Switch for panorama sun roof

The switch operates in two stages. Whenever the switch is pressed or pulled to the second stage, the sun roof automatically opens or closes all the way. The sun roof will stop moving immediately if the switch is operated again.

### ① Tilting open/closing

- ▶ To tilt the sun roof fully open, briefly press the switch to the second position.
- ▶ To close the sun roof completely, briefly pull the switch downwards to the second position or briefly slide the switch forwards to the second position ⇒ ⚠.
- ▶ To set an intermediate position, press/pull the switch to the first position until the sun roof has reached the desired position.

### ② Sliding open/closing

- ▶ To slide the sun roof fully open, briefly slide the switch backwards to the second position.
- ▶ To close the sun roof completely, briefly slide the switch forwards to the second position or briefly pull the switch downwards to the second position ⇒ ⚠.
- ▶ To set an intermediate position, press the switch forwards/backwards to the first position until the sun roof has reached the desired position.

### Sun blind

The sun blind can be opened and closed by hand when the panorama sun roof is open in any posi-

tion. The sun blind can be adjusted to any intermediate position.

### ⚠ WARNING

Take care when closing the panorama sun roof. Careless or uncontrolled use can cause injuries. For this reason, always take the ignition key with you when leaving the vehicle.

### ! CAUTION

You should always close your panorama sun roof when leaving the car. Sudden rain could seriously damage your car's interior equipment, especially the on-board electronic systems.

### i Note

- Details on the convenience open/close function ⇒ page 47.
- The panorama sun roof can be operated for about ten minutes after the ignition has been switched off. The switch is deactivated immediately when one of the front doors is opened.
- The panorama sun roof can be opened only at temperatures above -20 °C.

### Closing the panorama sun roof manually

Applies to: vehicles with panorama sun roof

If the panorama sun roof detects any resistance while it is closing (e.g. caused by an object trapped in the mechanism), a safety cut-out will be triggered and the roof will open again automatically. If the roof will still not close automatically after you remove the object and operate the switch again, you can use the safety cut-out override to close it.

- ▶ After the sun roof opens automatically, pull and hold the switch within 5 seconds until the sun roof is closed.

If you release the switch before the panorama sun roof is fully closed, it will open again automatically.

## Lights and vision

### Exterior lights

#### Switching lights on and off



Fig. 37 Dashboard: Light switch with buttons

#### Light switch

With the ignition switched on, turn the light switch to the appropriate position. The  symbol and the selected position will light up (except if the switch is at position 0).

0 - On vehicles for some markets, the daytime running lights, tail lights and number plate light are switched on permanently.

AUTO - The headlights are switched on automatically according to the ambient light conditions.

 - Side lights

 - Dipped headlights

#### Buttons

When you turn the light switch to AUTO or dipped headlights , you can activate the following functions:

 - All-weather lights\*. The front lights are adjusted automatically so that the headlights on your own vehicle are less dazzling to you, for instance when you are driving on a wet road.

 - Rear fog light(s)

#### Headlight range control

On vehicles with LED headlights\*, the headlight beam settings are adjusted automatically (even during braking and acceleration).

On vehicles with halogen headlights, the knob  Fig. 37 must be used to adjust the headlight beam settings:

- Briefly press the knob to release it.
- Turn the knob towards 3 or 0 to reduce or increase the range of the headlights.
- Briefly press the knob again to engage it.

0 - One or two front occupants, luggage compartment empty

1 - All seats occupied, luggage compartment empty

2 - All seats occupied, luggage compartment loaded

3 - Driver only, luggage compartment loaded

#### Audi adaptive light

Applies to: vehicles with adaptive light

With the adaptive light feature, you have better vision in the dark because the lights are controlled dynamically to match the vehicle speed and road conditions, e.g. on motorways or country roads, at intersections or through corners. The adaptive light is activated only when the light switch is set to AUTO and the all-weather lights\* are switched off.

#### WARNING

- The automatic headlights are only intended to assist the driver. The driver must always ensure that the headlights are used when required, and may have to switch them on manually when the light conditions or visibility are poor. For example, the light sensors are not able to detect fog. Therefore, you should always switch on the dipped headlights  in these conditions and when driving after dark.
- To avoid dazzling the traffic behind you, the rear fog light should only be used in accordance with statutory regulations.
- If the vehicle battery has been losing charge for a while, the side lights or parking lights may be switched off automatically. Always park your car in a safe and suitably lit place according to the applicable regulations.

Avoid using the side lights for long periods (several hours). If possible, switch the left or right parking lights on.

- Observe all relevant statutory requirements when using the lighting systems described here.

### **i** Note

- The light sensor for the automatic headlights\* is located in the mounting for the interior mirror. Do not affix any stickers on this section of the windscreen.
- Depending on the export market, the rear lights on some vehicles may be switched on together with the headlights when the daytime running lights\* are activated. On other vehicles, the rear lights remain off.
- In cool or damp weather, the inside of the headlights, turn signals or rear lights can sometimes mist up, due to the temperature difference between the interior and exterior of the car. They should clear again partially or completely soon after you switch on the headlights. This phenomenon has no influence on the life expectancy of the vehicle lights.

## Turn signal and main beam lever

The turn signal lever also operates the main beam headlights, parking lights and headlight flasher.



Fig. 38 Turn signal and main beam headlight lever

### Turn signals and parking lights

The turn signals will flash if you move the lever while the ignition is switched on. The parking

lights will be switched on if you do this with the ignition switched off.

- ① - Turn signals/parking lights (right side)
- ② - Turn signals/parking lights (left side)

If you just tap the lever, the turn signals will flash three times (one-touch signalling).

### Main beam and headlight flasher

Move the lever to the appropriate position:

- ③ - Main beam headlights on (vehicles with main beam assist\* ⇒ page 50)
- ④ - Main beam headlights off or headlight flasher

The indicator lamp will light up in the instrument cluster.

### WARNING

The main beam can dazzle other drivers. Risk of accident! Never use the main beam headlights or the headlight flasher if they could dazzle other drivers.

### **i** Note

A buzzer will sound if you open the door when the parking light is on.

## Main beam assist



Applies to: vehicles with main beam assist

The main beam assist automatically switches the main beam headlights on or off depending on the surrounding light conditions.

A camera (located in the mounting for the interior mirror) detects light sources from other road users. The main beams are activated/deactivated automatically depending on the position of vehicles on either side of the road, on the road speed, and on other traffic and ambient conditions.

### Activating the main beam assist

Important: The light switch must be set to AUTO, the dipped beam headlights must be on and the main beam assist must be activated on the infotainment system ⇒ page 51.

- ▶ Press the lever forwards ③ ⇒ page 50, Fig. 38 to activate the main beam assist. The indicator lamp  will light up in the instrument cluster display and the main beams will be switched on/off automatically. An indicator lamp  lights up when the main beams are switched on.

### Switching the main beams on/off manually

If the main beams are not switched on or if the headlights are not dipped as expected, you can control the dip function manually:

- ▶ To switch on the main beams manually, push the lever forwards ③. The indicator lamp  will light up. To dip the headlights again, pull the lever towards you ④.
- ▶ To dip the headlights manually, pull the lever towards you ④. The main beam assist will be deactivated.

### Flashing the headlights

- ▶ Pull the lever towards you ④ to flash the headlights when the main beam assist is activated and the main beams are dipped. The main beam assist will remain activated.

### Driver messages in the instrument cluster display

 **Main beam assist: system fault!**

 **Main beam assist: fault. See owner's manual**

Drive to a qualified workshop soon and have the fault rectified. You can still switch the main beam headlights on and off manually.

 **Main beam assist: currently unavailable. No camera view**

 **Main beam assist: currently unavailable. Camera view restricted due to surroundings. See owner's manual**

The camera vision is impaired, e.g. by stickers or dirt. Please clean the windscreen.

The sensor is located in the mounting for the interior mirror. Do not affix any stickers on this section of the windscreen.

### WARNING

The main beam assist is only intended to assist the driver. The driver must always ensure that the headlights are used when required, and may have to switch them on or off manually, e.g. when the light conditions or visibility are poor. In the following situations manual intervention may be necessary:

- Hazardous weather conditions such as fog, heavy rain and snow or water splashes
- Roads on which oncoming traffic is partially concealed (e.g. on motorways)
- Indiscernible road users (e.g. cyclists with poor lighting)
- Tight corners, steep hill crests or valleys
- Poorly lit towns
- Highly reflective objects, such as road signs
- Windscreen misted up, dirty, frosted or covered by stickers in front of the sensor

### Adjusting the settings for the exterior lighting

You can change the settings for these functions on the infotainment system.

- ▶ Select the following on the infotainment system: **MENU** button > **Car** > left control button > **Vehicle settings** > **Exterior lighting**.

### Automatic headlights\*

The following settings are available in the **Automatic headlights** menu:

**Activation time\*** - You can determine how soon the lights are switched on by using the settings **early\***, **medium\*** or **late\*** to adjust the sensitivity of the light sensor.

**Main beam assist\*** - You can switch the main beam assist\* on/off.

### Entry/exit lights\*

You can switch the entry/exit lights\* on and off. They illuminate the area around the vehicle after dark when you unlock the vehicle or when the ignition has been switched off and the driver's door opened. ▶

The entry/exit lights are operational only after dark when the light switch is set to **AUTO**.

### Headlight dip settings for driving at home and abroad\*

If you drive a right-hand drive vehicle in a left-hand drive country, or vice versa, it is not necessary to adjust the headlights, as they are designed for use when driving on the left or right.

### Hazard warning lights



Fig. 39 Dashboard: Switch for hazard warning lights

The hazard warning lights are used to make other road users aware of your vehicle in hazardous situations.

- ▶ Press the switch  to switch the hazard warning lights on/off.

If you brake hard at high speed, the brake lights will flash and the hazard warning lights will come on automatically<sup>1)</sup>.

You can use the turn signals to indicate a change of direction (or lane) even when the hazard warning lights are on. The hazard warning lights will be interrupted temporarily.

The hazard warning lights also work when the ignition is switched off.

## Interior lights

### Front interior lights





Fig. 40 Headliner: Front interior lights (example)

Press the corresponding switch:

\* - Interior lights on/off

 - Courtesy lighting on/off. The interior lights are switched on and off automatically when this function is activated.

Applies to: vehicles with touch-sensitive reading lights



- ▶ Briefly touch the surface   $\Rightarrow$  Fig. 40 to turn the appropriate reading light on/off.
- ▶ To use the manual dimmer function, touch the surface  when the light is switched off, and hold your finger on the surface until the desired brightness level is reached.

### Rear interior lights

Applies to: vehicles with rear reading lights



Fig. 41 Headliner: Rear reading lights (example)

- ▶ Press the  or \* button to switch the appropriate reading light on/off.

<sup>1)</sup> This function is not available on all export versions.

## Background lighting

Applies to: vehicles with background lighting

The background lighting can be adjusted via the infotainment system.

- ▶ Select the following on the infotainment system: **MENU** button > **Car** > left control button > **Vehicle settings** > **Background lighting**.

It may be possible to adjust the brightness of the individual zones, depending on the equipment fitted in your vehicle:

- ▶ Press the right control button and select one of the zones displayed.

The background lighting will be switched on when you switch on the headlights with the ignition on.

## Instrument lighting

The background lighting of the instruments and displays (including the head-up display\*) can be adjusted as required.



Fig. 42 Instrument lighting

- ▶ Briefly press the knob to release it.
- ▶ Turn the knob towards "-" or "+" to reduce or increase the brightness of the lighting.
- ▶ Briefly press the knob again to engage it.

### **i** Note

Depending on the vehicle equipment, the instrument lighting (for dials and needles) may be switched on when the ignition is on and the vehicle's lights are off. The illumination of the dials and needles is automatically reduced as it becomes dark outside and is eventually switched off altogether. This function is in-

tended to remind the driver to switch on the dipped headlights in good time.

## Clear vision

### Adjusting the exterior mirrors



Fig. 43 Driver's door: Adjuster knob for exterior mirrors (example)

Turn the knob to the appropriate position:

0 - To deactivate all setting functions.

↔ - To adjust the exterior mirror (left or right side). Move the knob in the desired direction.

☀ - To heat\* the mirrors (depends on the outside temperature).

↔ - To fold in the exterior mirrors\*. To fold the mirrors out, turn the knob to any of the other positions. One of the infotainment settings allows you to control whether or not the mirrors are folded in when you lock the vehicle ⇒ page 41.

### Tilt function\* for front passenger's exterior mirror

The mirror is tilted slightly to provide a better view of the kerb when parking backwards. This feature only works when the knob is in the position for adjusting the mirror on the passenger side.

You can adjust the tilted mirror surface by moving the knob in the desired direction. This new position is automatically stored and assigned to the remote control key when you take the car out of reverse.

The mirror returns to its original position as soon as you drive forwards at over 15 km/h or switch off the ignition. ▶

### **WARNING**

Convex or wide-angle\* exterior mirrors give a larger field of vision. However, they make objects look smaller and further away than they really are. If you use these mirrors to estimate the distance to vehicles behind you when changing lane, you could misjudge the distance. Risk of accident!

### **CAUTION**

- Applies to vehicles with electrically retractable exterior mirrors: If one of the mirror housings is knocked out of position (e.g. when parking), the mirrors must be fully retracted with the electric control. You will hear a loud noise when the mirrors snap back into place. Do not readjust the mirror housing by hand, as this will interfere with the mirror adjuster function.
- Applies to vehicles without electrically retractable exterior mirrors: If one of the mirror housings is knocked out of position (e.g. when parking), it must be returned to its proper position by hand.
- Before washing the vehicle in an automatic car wash, please make sure to retract the exterior mirrors to prevent them from being damaged. Electrically retractable exterior mirrors\* must NOT be folded in or out by hand. Always use the electrical power control.

### **Note**

If the electrical adjustment should fail to operate, both of the mirrors can be adjusted by hand by lightly pressing the edge of the mirror glass.

## Anti-dazzle setting

Your vehicle is equipped with a manual or automatic\* anti-dazzle interior mirror.

### Manual anti-dazzle interior mirror

- ▶ Pull the lever at the bottom of the mirror towards you.

### Automatic anti-dazzle mirrors\*

- ▶ The interior and exterior mirrors will darken when bright light (e.g. from the headlights of a following vehicle) shines on the surface of the interior mirror.

### **WARNING**

Applies to: vehicles with automatic anti-dazzle mirrors

Electrolyte fluid can leak from a broken mirror. This fluid can cause irritation to the skin, eyes, and respiratory organs. Wash thoroughly with clean water should you come into contact with this fluid. Seek medical assistance if needed.

### **CAUTION**

Applies to: vehicles with automatic anti-dazzle mirrors

Electrolyte fluid can leak from a broken mirror. This fluid can damage plastic surfaces. Use a wet sponge or similar to remove the fluid as soon as possible.

### **Note**

Applies to: vehicles with automatic anti-dazzle mirrors

- The automatic anti-dazzle mirrors may not function as intended if the light falling on the surface of the interior mirror is obstructed.
- The automatic anti-dazzle mirrors do not darken if the interior lighting is on or the car is in reverse gear.

## Sun visors

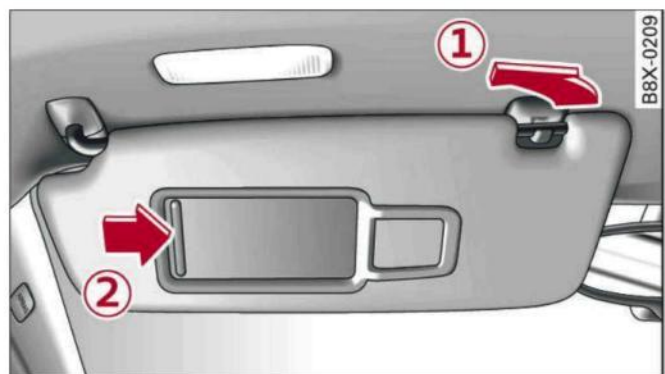



Fig. 44 Left side: Sun visor (example)

- ▶ The sun visor can be pulled out of its mounting and turned towards the door .



The light\* for the make-up mirror comes on automatically when you slide open the mirror cover

②.

## Windscreen wipers

### Switching on the windscreen wipers

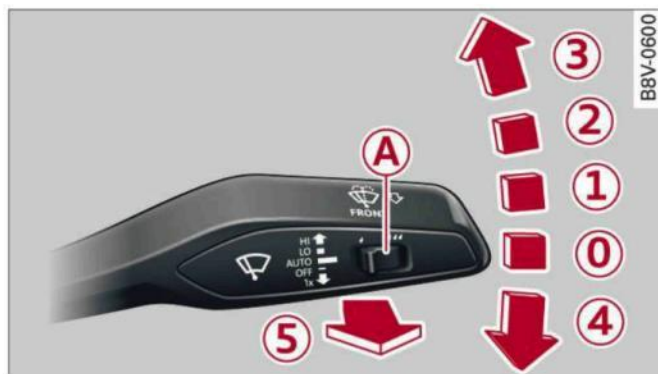

Fig. 45 Windscreen wiper lever



Fig. 46 Control lever for rear wiper

Move the windscreen wiper lever to the appropriate position:

① - Wipers off

① - Intermittent wipe. Move switch **A** to the left or to the right to increase or reduce the wiper delay interval. If your vehicle is equipped with a rain sensor\*, the windscreen wipers will be activated automatically in the rain as long as the vehicle has been moving faster than approx. 4 km/h at least once. The higher the sensitivity level for the rain sensor (i.e. the further switch **A** is moved to the right), the sooner the windscreen wipers react to moisture on the windscreen. You can deactivate the rain sensor mode on the infotainment system (this will activate the intermittent wipe mode). To do so, select: **MENU** button > **Car** > left control button > **Driver assist** > **Rain sensor**.

② - Slow wipe

③ - Fast wipe

④ - Single wipe. If you hold the lever in this position, the wipers will switch from slow continuous wiping to fast continuous wiping after a while.

⑤ - Wash/wipe. The screen is given an extra wipe a few seconds later to remove any dribbles of water (if the vehicle is moving and the temperature is above approx. 4 °C). You can deactivate this function by moving the lever to position ⑤ again within 10 seconds after the extra wipe. The extra-wipe function is activated again the next time you switch on the ignition.

Headlight washers\*. The headlight washer system\* only operates when the dipped headlights are switched on. The headlights are also automatically washed intermittently when you move the lever to position ⑤.

⑥ - Rear wipe. The rear window is wiped approximately every 6 seconds.

If the windscreen wipers are on and in operation, the rear window wiper will also be switched on automatically when you engage reverse gear.

⑦ - Rear wash/wipe. The number of wiper cycles depends on how long you hold the lever in position ⑦.

### **!** WARNING

- The rain sensor\* is only intended to assist the driver. The driver is still obliged to manually operate the windscreen wipers as required depending on visibility.
- Do not use water-repellent coatings on the windscreen. In bad visibility conditions such as light rain, low sun or when driving at night these coatings can cause increased dazzle, which is a serious safety hazard. Such coatings can also cause the wiper blades to judder.
- Poor visibility can cause accidents. Always ensure that the wiper blades are in good condition ⇒ page 56, *Changing the windscreen wiper blades*.

**! CAUTION**

- In icy conditions, check that the wiper blades are not frozen to the windscreen. If the wiper blades are frozen to the windscreen when you switch on the windscreen wipers, this could damage the wiper blades.
- Make sure you switch off the windscreen wiper system (lever in position ①) before you use an automatic car wash. This will avoid inadvertent triggering of the wipers and possible damage to the wiper system.

**i Note**

- The windscreen wipers are deactivated when the ignition is switched off. You can activate the windscreen wipers after switching the ignition on again by moving the windscreen wiper lever to any position.
- Worn or dirty wiper blades can cause smearing on the glass. This can also impair the effectiveness of the rain sensor. Please check the wiper blades regularly.
- The windscreen washer jets are heated\* when the ignition is switched on if the outside temperature is low.
- If you stop briefly, e.g. at traffic lights, the wiper speed setting will automatically be reduced by one level.

**Cleaning the wiper blades**

Clean the wiper blades if the wipers leave smearing on the glass. Use a soft cloth and glass cleaning solution.

**Windscreen wipers**

- ▶ Set the wiper arms to the service position ⇒ page 56.
- ▶ Lift the wiper arms away from the glass.

**Rear window wiper**

- ▶ Lift the rear wiper arm away from the glass.

**! WARNING**

Dirty wiper blades can impair the driver's view - risk of accident!

**! CAUTION**

If the wipers still leave smearing on the glass after they have been cleaned, the wiper blades should be replaced ⇒ page 56.

**Changing the windscreen wiper blades**

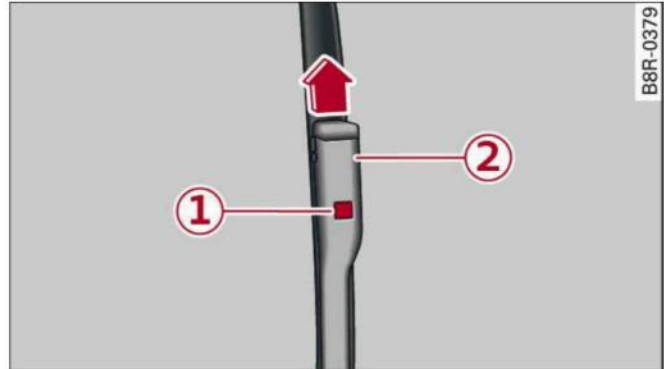

Fig. 47 Removing the wiper blades

**Service position / wiper change position**

- ▶ To move the windscreen wipers into the service position, switch off the ignition and move the windscreen wiper lever to position ④ for at least 2 seconds ⇒ page 55, Fig. 45.
- ▶ To move the windscreen wipers back to their original position, switch on the ignition and move the windscreen wiper lever to position ④ for at least 2 seconds.

**Taking off the wiper blade**

- ▶ Lift the wiper arm away from the glass.
- ▶ Press the release button ① on the wiper blade ⇒ Fig. 47. Keep hold of the wiper blade while doing so.
- ▶ Take off the wiper blade in the direction of the arrow.

**Fitting the wiper blade**

- ▶ Fit the new wiper blade into the mounting on the wiper arm ②. You should hear it engage in the wiper arm.
- ▶ Fold the wiper arm back down onto the windscreen.
- ▶ Switch off the service position again.

**! WARNING**

For safety, the wiper blades should be changed once or twice a year.

**!** CAUTION

- The wipers must be in the service position before lifting them off the windscreen! Otherwise the wiper motor or the paintwork on the bonnet may be damaged.
- Never drive your vehicle or operate the windscreen wiper lever while the wiper arms are off the glass in a raised position. The wipers will otherwise automatically return to their park position and may damage the bonnet and windscreen.

**i** Note

- You can also use the service position, for example, if you want to fix a cover over the windscreen in the winter to keep it clear of ice.
- You cannot activate the service position when the bonnet is open.

**!** WARNING

For safety, the wiper blades should be changed once or twice a year.

### Changing the rear wiper blade

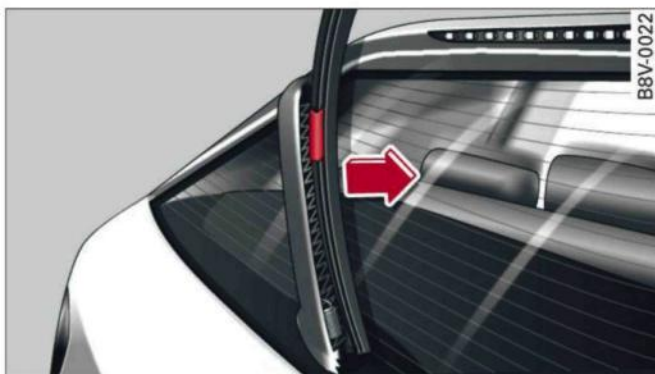

Fig. 48 Rear window wiper: Removing the wiper blade

#### Taking off the wiper blade

- ▶ Lift the rear wiper arm away from the glass.
- ▶ Take hold of the wiper blade below the centre and pull the blade out of the retainer in the direction of the -arrow- ⇒ Fig. 48. Keep hold of the wiper arm while doing so.

#### Fitting the wiper blade

- ▶ Press the mounting on the wiper blade into the retainer. While doing so, keep holding the plastic top end of the wiper arm.
- ▶ Fold the wiper arm back down onto the rear window.

## Seats and storage

### General notes

#### WARNING

The Safe driving chapter ⇒ *page 263, Safe driving* contains important information, tips, suggestions and warnings that you should read and observe for your own safety and the safety of your passengers.

### Front seats

#### Manual adjustment of seats

Applies to: vehicles with manual seat adjustment



Fig. 49 Front seat: Manual adjustment

- ① - Seat forwards/backwards: Lift the lever and move the seat.
- ② - Lumbar support\*: Press the appropriate side of the button.
- ③ - Seat height: Pull/press the lever.
- ④ - Backrest angle: Turn the knob.

#### WARNING

- Never adjust the front seats when the vehicle is moving – this could lead to an accident.
- Be careful when adjusting the seat height. Careless or uncontrolled use of the seat adjustment can cause injuries.
- Do not drive with the backrests of the front seats reclined too far as otherwise the seat belts and airbags could fail to restrain the occupants properly in an accident, possibly leading to injury.

#### Front centre armrest

Applies to: vehicles with front centre armrest

*There is a storage compartment underneath the armrest.*



Fig. 50 Armrest between driver's seat and front passenger's seat

- ▶ To adjust the angle, lift the armrest out of the initial position until it engages in the desired position.
- ▶ To move the armrest back to the initial position, lift the armrest slightly from the top click stop and then fold it back down.

You can move the armrest backwards or forwards.

### Head restraints

#### Front head restraints

Applies to: vehicles with adjustable head restraints

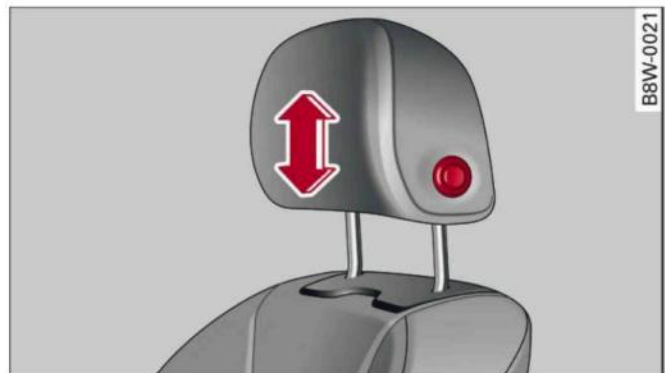

Fig. 51 Front seat: Adjusting head restraint

Adjust the head restraint so that the top of the head restraint is level with the top of your head. If this is not possible, try to adjust the head restraint as near as possible to this position.

- ▶ To raise the head restraint, take hold of it on both sides and move it up as required ⇒ *Fig. 51.* ▶

- ▶ To lower the head restraint, press the side button and slide the head restraint downwards.

**! WARNING**

Please observe the safety warnings  
⇒ page 266, *Correct adjustment of head restraints.*

**Rear head restraints**

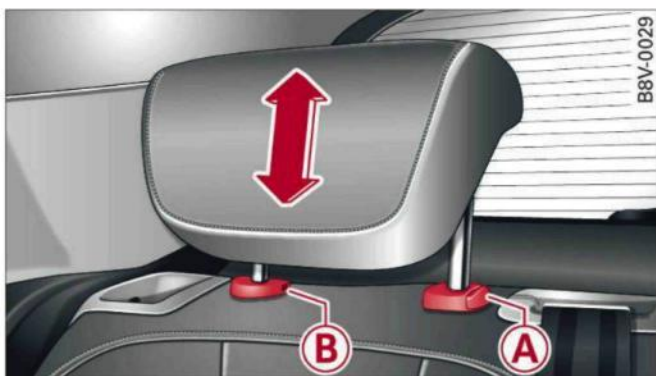

Fig. 52 Rear outer head restraint: Release point (example)

Before carrying passengers on the rear seats, pull the head restraints on the occupied seats up at least one notch ⇒ **!**

**Adjusting head restraints**

- ▶ To raise the head restraint, take hold of it on both sides and move it all the way up until you feel it click into place.
- ▶ To lower the head restraint, press button **A** ⇒ Fig. 52 and slide the head restraint downwards.

**Removing head restraints**

The backrest on the appropriate side has to be tipped forwards slightly in order to remove the head restraint.

Applies to vehicles with load-through hatch: The inner rear head restraint has no opening and can be removed without a screwdriver.

- ▶ Take the screwdriver\* out of the vehicle tool kit ⇒ page 319.
- ▶ Release the backrest ⇒ page 63.
- ▶ Press button **A** ⇒ Fig. 52 and slide the head restraint upwards as far as the stop.

- ▶ Insert the screwdriver in the opening\* **B**, press button **A** and at the same time pull the head restraint out of the backrest ⇒ **!**
- ▶ Push the backrest up until it engages securely ⇒ **!** in *Extending the luggage compartment* on page 63.

**Installing head restraints**

The backrest on the appropriate side has to be tipped forwards slightly in order to install the head restraints.

- ▶ Release the backrest ⇒ page 63.
- ▶ Push the posts of the head restraint into the guides until you feel them click into place. It should no longer be possible to pull the head restraint out of the backrest.
- ▶ Push the backrest up until it engages securely ⇒ **!** in *Extending the luggage compartment* on page 63.

**! WARNING**

- Please observe the safety warnings ⇒ page 266, *Correct adjustment of head restraints.*
- Remove the rear head restraints only if this is necessary in order to attach a child seat ⇒ page 267, *Child seats.* Install the head restraint again immediately after removing the child seat. Travelling with the head restraints removed or not raised increases the risk of severe injuries.

**Ashtray**

Applies to: vehicles with ashtray



Fig. 53 Front centre console: Ashtray

The ashtray is inserted in the centre console and can be placed on either the driver's or front passenger's side. Lift the lid to open the ashtray. Always put the ashtray safely back into the holder after removing it (e.g. after emptying it).

### **WARNING**

Never put waste paper in the ashtray, as this could cause a fire.

## Cigarette lighter

Applies to: vehicles with cigarette lighter



Fig. 54 Centre console: Cigarette lighter

- ▶ Press in the cigarette lighter.
- ▶ When the cigarette lighter springs out, pull it out completely.

The cigarette lighter should only be used as a power source in exceptional circumstances, e.g. for the compressor of the tyre repair kit.

### **WARNING**

The cigarette lighter only works when the ignition is on. Improper use can cause serious injury or start a fire. To avoid the risk of injury, never leave children unsupervised in the vehicle with the key.

## Power sources



Fig. 55 12 Volt socket and USB inputs

When the ignition is switched on or the engine is running, the following electrical power sources for external devices are available (depending on the equipment fitted in your vehicle):

### **12 Volt sockets** ①

Electrical equipment can be connected to the 12 Volt sockets. The appliances connected must not exceed a power rating of 120 W.

The 12 Volt sockets are located in the front centre console\*, in the rear\* and in the luggage compartment side trim\*.

### **USB inputs** ②

You can charge your mobile devices and/or connect them to the Audi music interface using the USB inputs:

-  Audi music interface\* in the centre armrest and at the front of the centre console. Or:
- CHARGE ONLY: USB charging socket\* in the centre armrest.
- CHARGE ONLY: Two USB charging sockets\* on the centre console in the rear.

For more information on the USB inputs, please refer to ⇒ page 240, *Multimedia connections*.

### **Audi phone box**

The Audi phone box\* is located in the centre console beneath the armrest. You can use it to charge your mobile phone ⇒ page 177.

### **WARNING**

Improper use can cause serious injury or start a fire. To avoid the risk of injury, never leave

children unsupervised in the vehicle with the key.

**! CAUTION**

- To avoid damage, please take care when detaching connectors from the electrical power sources.
- To avoid damage to the vehicle's electrical system, never connect equipment that generates electrical current, such as a solar panel or battery charger, to the power sources in order to charge the vehicle's battery.
- Always use the correct type of plugs to avoid damaging the power sources.

**i Note**

USB charging sockets marked "CHARGE ONLY" cannot transfer data and are intended for charging only.

## Storage

### Cup holders



Fig. 56 Detail of the rear seat bench: Rear cup holder\*

Your vehicle has cup holders in the front centre console, in the door trim and in the rear centre armrest\*.

#### Rear cup holders\*

- ▶ Swivel the centre armrest downwards.
- ▶ To open the cup holder, press the button ⇒ Fig. 56.
- ▶ Place your drinks in the holder.
- ▶ To close the cup holders, slide the cover back until it engages.

**! WARNING**

- Do not put any hot drinks in the cup holders while the vehicle is moving. You could be scalded if the hot liquid is spilt.
- Do not use cups, mugs or glasses made from hard materials such as glass or porcelain. These could cause injury in the event of an accident.

**! CAUTION**

You should avoid putting open drinks containers in the cup holders. The drinks could otherwise spill over and cause damage to e.g. the electrical equipment or the seat covers.

### Further storage compartments and retainers

You will find further storage compartments and retainers at various points in the vehicle:

- Glove box: The glove box can be locked\* with the key
- Storage compartment underneath the front centre armrest\*
- Storage compartment at the front end of the front seats\*. This compartment can hold objects weighing up to 1 kg
- Coat hooks\* above the rear doors
- Side retaining hooks\* in the luggage compartment

**! WARNING**

- To avoid the risk of injuries, always keep the glove box lid closed when driving.
- The storage compartments in the door trims should only be used to store small objects. Make sure that they are stored safely inside the compartment, as otherwise they might impair the protection offered by the side airbags.
- The retaining hooks should only be used to hold objects weighing up to 3 kg. Heavier objects cannot be safely secured – risk of injury!

**! WARNING**

Applies to: vehicles with coat hooks

- Make sure that any items of clothing hanging from the coat hooks do not obstruct your view to the rear.
- Only use the coat hooks for light items of clothing and make sure that there are no heavy or sharp objects in the pockets.
- Do not use clothes hangers to hang up the clothing, as this could interfere with the function of the head-protection airbags.

## Luggage compartment

### General notes

**! WARNING**

Please refer to the important safety notes on ⇒ page 272, *Stowing luggage safely.*

### Luggage compartment cover

Applies to: vehicles with luggage compartment cover

*The luggage compartment cover blocks the view into the luggage compartment.*



Fig. 57 Open boot lid with luggage compartment cover

### Removing

- ▶ Detach the cords ① and pull the cover ③ out of the retainers ② in the direction of the arrows.

### Installing

- ▶ Push the cover ③ horizontally into the retainers ② on the side trim until it engages.
- ▶ Attach the cords to the boot lid ① ⇒ **!.**

**! WARNING**

- The luggage compartment cover must always be fixed properly – risk of accident!
- The luggage compartment cover should not be used as a storage shelf. Items placed on this cover could cause injury in an accident or if the brakes are applied suddenly.

### Lowering the luggage compartment floor panel

Applies to: vehicles with lowerable floor panel

*You can lower the floor panel to increase the loading height in the luggage compartment.*



Fig. 58 Luggage compartment: Floor panel lowered

- ▶ To lower the floor panel, first lift it.
- ▶ Then pull the floor panel back slightly and re-insert it lower down at position ②.

When you no longer need the extra height, you should return the floor panel to position ①; this will make it easier to load and unload normal items of luggage.

### Fastening rings

Applies to: vehicles with fastening rings



Fig. 59 Luggage compartment: Location of fastening rings



- ▶ Use the fastening rings to secure the load -arrows-.
- ▶ Please refer to the safety notes ⇒ page 273.

### Stretch net/storage net

Applies to: vehicles with stretch net/storage net

The stretch net can be used to secure and hold light items in the luggage compartment.



Fig. 60 Luggage compartment: Stretch net attached (example)



Fig. 61 Luggage compartment: Storage net attached (example)

### Stretch net

- ▶ To secure the stretch net, insert first the front hooks and then the rear hooks of the stretch net into the fastening rings -arrows- ⇒ Fig. 60.

### Storage net

- ▶ To secure the storage net, insert the two hooks into the fastening rings **B** ⇒ Fig. 61 and attach the loops **A** to the retaining hooks\* **C**.

You can also use the retaining hooks\* **C** to secure light items of luggage, such as shopping bags, etc.

### ! WARNING

The stretch net should only be used to hold objects weighing up to 5 kg. Heavier objects cannot be safely secured – risk of injury!

### Extending the luggage compartment

Applies to: vehicles with folding backrest

The backrests can be folded down separately\* or together.

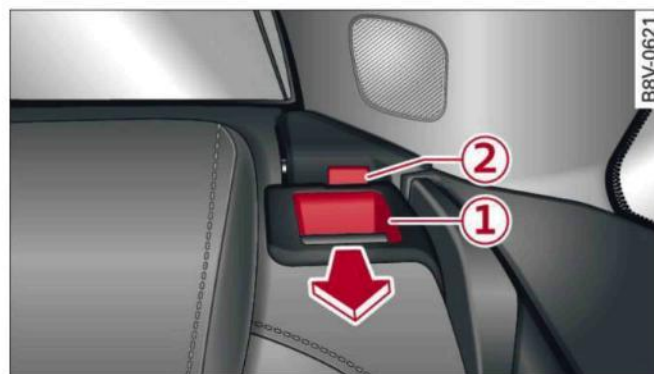

Fig. 62 Backrest: Outer release lever (example)

### Folding outer backrest up/down

- ▶ Slide the head restraint(s) downwards ⇒ page 59.
- ▶ Pull the release lever **1** ⇒ Fig. 62 in the direction indicated by the arrow and fold down the backrest.
- ▶ Push the backrest up until it engages securely ⇒ **!**. The red marking on the tab **2** should no longer be visible when the backrest is properly secured.

### Folding centre backrest up/down\*

Please note the information on ⇒ page 64, Load-through hatch.

### ! WARNING

- Make sure that the rear backrest is securely locked in position so that the seat belt can provide proper protection in the rear seats.
- The rear backrest must always be securely latched so that objects stored in the luggage compartment will not fly forward during sudden braking.

### ! CAUTION

- If you need to adjust the front seats when either of the rear backrests is folded forwards, please take care to avoid damaging the rear head restraints. If necessary, remove the appropriate head restraints before you slide back the front seats.
- Lower the rear head restraints before you fold down the backrest ⇒ ⚠ in *Rear head restraints on page 59* – risk of damage!
- When returning the backrest to an upright position, make sure that the seat belts for the outer rear seats are not caught up and damaged in the catches for the backrest.

### Load-through hatch

Applies to: vehicles with load-through hatch

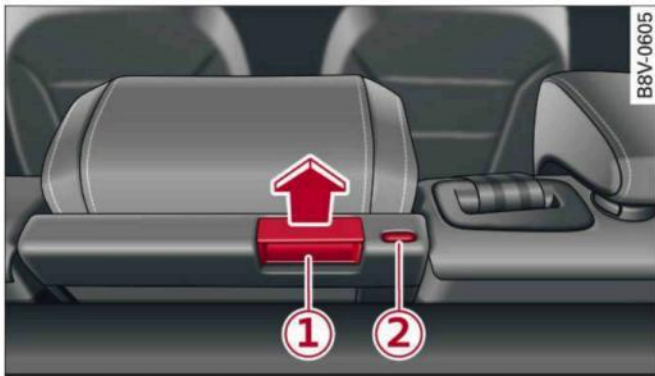

Fig. 63 Backrest: Releasing load-through hatch

### Opening/closing the load-through hatch

The load-through hatch can be opened from the passenger compartment or from the luggage compartment.

- ▶ To open the load-through hatch, pull the top release lever ① ⇒ Fig. 63 and fold down the backrest.
- ▶ To close the load-through hatch, push the backrest up until it engages securely ⇒ ⚠. The red marking on the tab ② should no longer be visible when the backrest is properly secured.

### ! WARNING

- Make sure that the rear backrest is securely locked in position so that the seat belt can provide proper protection in the rear seats.

- The rear backrest must always be securely latched so that objects stored in the luggage compartment will not fly forward during sudden braking.
- Make sure that all objects transported in the load-through hatch are secured. They can be catapulted through the passenger compartment in case of a sudden braking manoeuvre – risk of injury!
- Cover any sharp edges on the objects you transport to ensure that they do not cause any damage.

### ! CAUTION

When returning the backrest to an upright position, make sure that the seat belts for the outer rear seats are not caught up and damaged in the catches for the backrest.

## Roof carrier

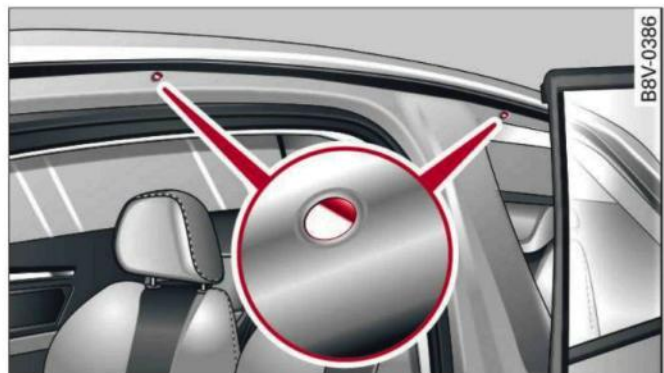



Fig. 64 Attachment points for roof carrier

Note the following points if you intend to carry loads on the roof:

- Only use roof carrier cross bars designed for your vehicle. The cross bars form the basic elements of a complete roof carrier system. Additional elements/carrier systems are needed in order to transport luggage and sports equipment. We recommend using roof carriers and additional elements from the range of Audi Genuine Accessories.
- The feet of the roof carrier cross bars must be attached at the points provided on the roof ⇒ Fig. 64.
- You should ensure that you do not exceed the maximum permitted axle loads, gross weight and roof load for your vehicle ⇒ page 343. The ▶

roof load limit applies to the combined weight of the roof carrier, the additional elements and the load itself. Please do not exceed the maximum carrying load of the carrier system you are using.

 **WARNING**

- Note the fitting instructions provided by the manufacturer of the roof carrier system. If you do not secure the roof carrier system and roof load correctly, they can become separated from the vehicle and cause an accident.
- The use of a roof carrier system affects the vehicle's handling by shifting the centre of gravity and increasing susceptibility to cross winds – risk of accident! Take extra care when driving and adjust your speed accordingly.

 **CAUTION**

- Any damage to the vehicle caused by the use of other types of roof rack or incorrect installation will not be covered by the factory warranty. The roof carrier system must therefore be installed exactly according to the instructions provided.
- Please take care that the boot lid and panorama sun roof\* do not come into contact with the roof load when opened.

 **For the sake of the environment**

The increased air resistance means that the vehicle uses more fuel. For this reason you should always take off the roof carrier when it is not in use.

# Heating and cooling

## Heating system/air conditioner

### Description

One of the following systems may be fitted, depending on the equipment in your vehicle:

- Heating and ventilation system or
- Manual air conditioner\* or
- Automatic air conditioner\* (deluxe version)

The **heating and ventilation system**\* heats and ventilates the vehicle interior. The **air conditioner**\* additionally cools and dehumidifies the air inside the vehicle. It operates most effectively with the windows and the panorama sun roof\* closed. If the vehicle has been standing in the sun, it may cool down faster if you open the windows briefly to let the hot air escape.

### Pollution filter

The pollution filter removes impurities, such as dust and pollen, from the air.

### Key-coded settings

Various settings are stored and assigned to the remote control key in use.

### Default settings

Default settings for certain functions can be selected on the infotainment system.

Select the following on the infotainment system: **MENU** button > **Car** > left control button > **A/C**.

### Supplementary heater\*

Applies to: vehicles with diesel engine

The vehicle interior warms up more quickly with the supplementary heater. The system automatically switches the supplementary heater on temporarily as required, depending on the setting on the vehicle heating system.

The supplementary heater function can be switched on or off as required. Select the follow-

ing on the infotainment system: **MENU** button > **Car** > left control button > **A/C** > **Auto supplementary heater**.



### For the sake of the environment

- Switch off the cooling mode on the air conditioner\* by pressing the A/C button if you wish to save fuel. This will also reduce emissions. The LED in the button will go out when the air conditioner is switched off.
- On vehicles with efficiency program\*, you can see how your fuel consumption is being affected by auxiliary equipment and have tips for improved fuel economy displayed ⇒ *page 21*.
- Applies to vehicles with diesel engine: The automatic supplementary heater function can be switched off on the infotainment system ⇒ *page 66, Supplementary heater\**.



### Note

- Keep the air intake slots in front of the windscreen clear of snow, ice and leaves to ensure unimpaired heating and cooling, and to prevent the windows misting over.
- Condensation can drip off the air cooling system\* and form a pool underneath the vehicle. This is normal and does not indicate a leak.
- If you notice, for instance, that the seat\* or rear window heating is not working, it may have been temporarily switched off by the power management function. These systems will be available again as soon as sufficient electrical power is available.



### Note

The air conditioner contains fluorinated greenhouse gases. Further information is provided on a sticker in the engine compartment<sup>1)</sup>.

<sup>1)</sup> May vary in different countries

## Heating/ventilation system or manual air conditioner

Applies to: vehicles with heating/ventilation system or manual air conditioner

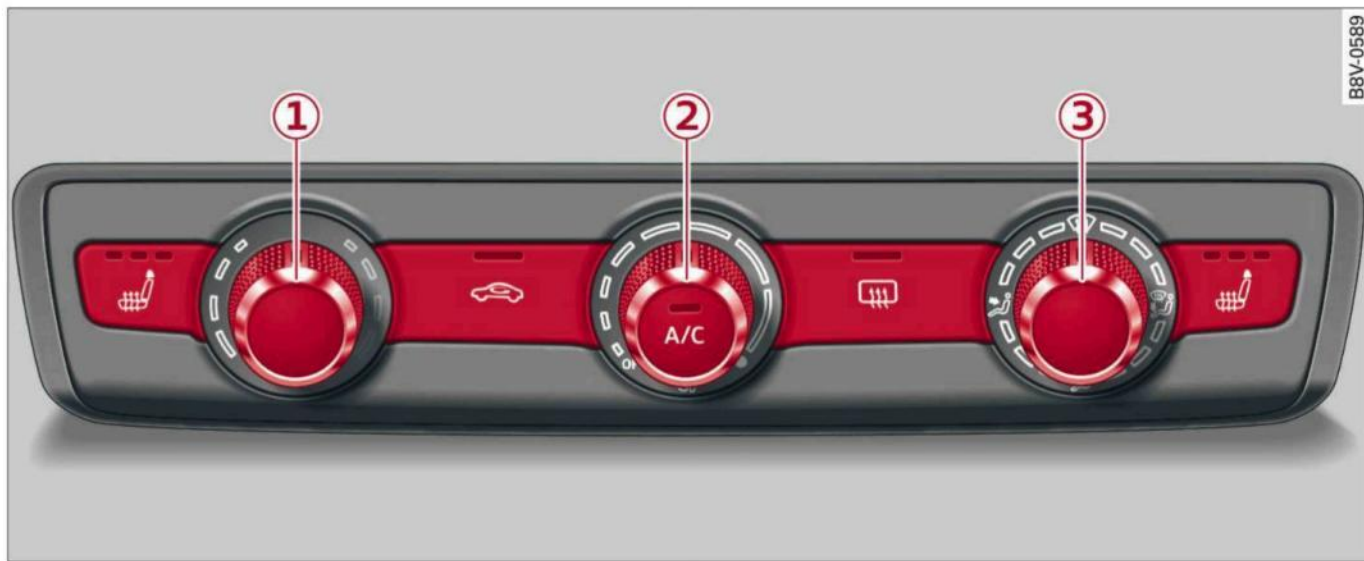

Fig. 65 Heating/ventilation system or manual air conditioner\*: Controls

The functions can be switched on and off using the buttons and controlled using the rotary controls. The LED in the corresponding button lights up when the function is switched on.

### Manual air conditioner\*

For a comfortable climate inside the vehicle using the air conditioner:

- In the summer, adjust the temperature to just a few degrees below the outside temperature
- Do not turn the blower up too high
- Do not point the air outlets directly at the occupants

### A/C Cooling mode\*

The air cooling system only works when the blower is switched on. The air cooling mode is switched on/off when the A/C button is pressed. When the air cooling is switched off, the air is not cooled and therefore not dehumidified. The windows may mist up as a result. The air cooling is switched off automatically at low outside temperatures.

### ● / ● Temperature

Rotary control ① is used to adjust the temperature.

### 🌀 Blower

You can adjust the blower speed manually using control ②. You should leave the blower on at a low setting to prevent the windows from misting up and to ensure that the vehicle interior is constantly ventilated. To demist the windows, we recommend that you increase the blower speed and set control ③ to 🌀.

### 🌀 / 🌀 / 🌀 / 🌀 Air distribution and air outlets

The rotary control ③ can be used to adjust the air distribution. A setting between 🌀 and 🌀 usually provides a comfortable environment.

At the 🌀 setting, the windscreen and side windows are defrosted or demisted as quickly as possible. The air recirculation is switched off, but can be switched on again manually by pressing the 🌀 button.

The round air outlets in the dashboard can be adjusted ⇨ [page 71](#).

To prevent the front side windows from misting up in wet weather, it's a good idea to open the side air outlets and point them to the side.

Foot-level air outlets are provided underneath the front seats to heat the rear cabin. ▶

### Air recirculation mode

In air recirculation mode, the air from the interior of the vehicle is filtered and recirculated. This setting prevents fumes etc. from entering the interior. We recommend switching on the air recirculation mode when driving through a tunnel or in traffic queues ⇒ .

The air recirculation mode is switched off when the control is in the defrost position .

### Rear window heating

If the rear window heating is activated with the ignition switched on, the battery management determines whether or not the vehicle battery charge level is sufficient for the rear window heating to be switched on. Otherwise the rear window heating operates when the engine is running, and switches off automatically after about 10 - 20 minutes, depending on the outside temperature.

To switch on the rear window heating permanently, press and hold the  button for at least 2 seconds. This setting will be stored for approximately 15 minutes after the ignition is switched off.

### Seat heating\*

When you press the  button, the seat heating is switched on at level 3 (the highest level). The LEDs indicate the temperature level. To reduce the temperature, press the button again. To

switch off the seat heating, press the button repeatedly until all the LEDs have gone out.

The seat heating automatically switches from level 3 to level 2 after about 10 minutes.

#### WARNING

- For reasons of safety you should not leave the air recirculation switched on for too long. This mode prevents fresh air from entering the vehicle, so the windows can mist over if the air cooling\* is switched off. Bad visibility can cause an accident.
- People with limited capacity to feel pain or sense temperature could burn themselves when using the seat heating. These people must not use the seat heating – risk of injury!

#### CAUTION

To avoid damaging the heating elements of the seat heating, please do not kneel on the seat or apply sharp pressure at a single point.

#### Note

- The setting for the driver's seat heating is assigned to the key in use.
- If the front passenger's seat heating was on when you last switched off the ignition, it will be switched on automatically only if the ignition is switched on again within 10 minutes.

## Automatic air conditioner

Applies to: vehicles with automatic air conditioner

We recommend pressing the AUTO button and setting the temperature to 22 °C (72 °F).



Fig. 66 Automatic air conditioner: Controls (example)

The functions can be switched on and off using the buttons and controlled using the rotary controls. The LED in the corresponding button lights up when the function is switched on.

### Automatic air conditioner

The air conditioner is fully automatic, and will maintain the desired temperature at a constant level. When the heater is on, the blower normally only switches to a higher speed once the coolant has warmed up sufficiently (this does not apply to the *defrost* setting).

#### AUTO Automatic or “eco” mode\*

The automatic mode maintains a constant temperature inside the vehicle. Air temperature, output and distribution are regulated automatically. The AUTO mode is switched off immediately when you operate any of the manual air controls.

The “eco” mode\*<sup>1)</sup> is activated if you press the AUTO button briefly while automatic mode is active. Fuel is saved in “eco” mode\* because the settings respond more passively. The “eco” mode\* is on when **eco** appears in the console display. The “eco” mode\* is deactivated when you press the AUTO button again.

### A/C Cooling mode

The air cooling system only works when the blower is switched on. The air cooling mode is switched on/off when the A/C button is pressed. When the air cooling is switched off, the air is not cooled and therefore not dehumidified. The windows may mist up as a result. The air cooling is switched off automatically at low outside temperatures.

#### ● / ● Temperature

The temperature for the driver's and front passenger's sides can be set separately using controls ① and ②. The temperature can be adjusted between +16 °C (+60 °F) and +28 °C (+84 °F). Outside this range, **LO** or **HI** will appear on the air conditioner display. In the two extreme settings the air conditioner operates continuously with maximum cooling or heating output, and the temperature is not regulated automatically.

**Synchronisation:** By pressing the AUTO button for 2 seconds, the temperature of the passenger's side can be set to the temperature of the driver's side. The settings remain synchronised until the temperature is changed on the passenger's side.

<sup>1)</sup> This function is not available on all export versions.

### **Blower**

You can adjust the blower speed manually using the control . You should leave the blower on at a low setting to prevent the windows from misting up and to ensure that the vehicle interior is constantly ventilated. Press the AUTO button for automatic control of the blower speed.

### **Air distribution and air outlets**

The buttons can be used to adjust the air distribution. Press the AUTO button for automatic air distribution.

The round air outlets in the dashboard can be adjusted ⇒ *page 71*.

To prevent the front side windows from misting up in wet weather, it's a good idea to open the side air outlets and point them to the side.

Foot-level air outlets are provided underneath the front seats to heat the rear cabin.

### **Defroster**

The windscreen and side windows are defrosted or demisted as quickly as possible. The air output is increased to maximum and most of the air comes out of the outlets below the windscreen. The air recirculation mode is deactivated. The temperature should be set to 22 °C or higher. The temperature is regulated automatically. At setting  the A/C cooling mode is automatically activated depending on the ambient temperature.

The defroster is switched off when the AUTO button is pressed.

### **Air recirculation mode**

The air recirculation mode can be switched on manually or automatically\*.

- To switch the manual air recirculation mode on/off, press the  button.
- The automatic\* air recirculation function must be activated on the infotainment system. Select the following on the infotainment system: **MENU** button > **Car** > left control button > **A/C** > **Auto recirculation**. The air quality sensor, which is designed for the detection of diesel and petrol exhaust fumes, automatically

switches the air recirculation mode on or off depending on the level of pollution in the outside air.

In air recirculation mode, the air from the interior of the vehicle is filtered and recirculated. This setting prevents fumes etc. from entering the interior. We recommend switching on the air recirculation mode when driving through a tunnel or in traffic queues ⇒ .

The air recirculation mode is switched off when the  or AUTO or  button is pressed.

If the engine is cold, the air conditioner will automatically switch to air recirculation mode when the vehicle is reversing.

### **Rear window heating**

If the rear window heating is activated with the ignition switched on, the battery management determines whether or not the battery charge level is sufficient for the rear window heating to be switched on. Otherwise the rear window heating operates when the engine is running, and switches off automatically after about 10 - 20 minutes, depending on the outside temperature.

To switch on the rear window heating permanently, press and hold the  button for at least 2 seconds. This setting will be stored for approximately 15 minutes after the ignition is switched off.

### **Seat heating\***

When you press the  button, the seat heating is switched on at level 3 (the highest level). The LEDs indicate the temperature level. To reduce the temperature, press the button again. To switch off the seat heating, press the button repeatedly until all the LEDs have gone out.

The seat heating automatically switches from level 3 to level 2 after about 10 minutes.

### **WARNING**

- For reasons of safety you should not leave the air recirculation switched on for too long. This mode prevents fresh air from entering the vehicle, so the windows can mist



over if the air cooling is switched off. Bad visibility can cause an accident.

- People with limited capacity to feel pain or sense temperature could burn themselves when using the seat heating. These people must not use the seat heating – risk of injury!

### ! CAUTION

To avoid damaging the heating elements of the seat heating, please do not kneel on the seat or apply sharp pressure at a single point.

### i Note

- The setting for the driver's seat heating is assigned to the key in use.
- If the front passenger's seat heating was on when you last switched off the ignition, it will be switched on automatically only if the ignition is switched on again within 10 minutes.

## Adjusting air outlets

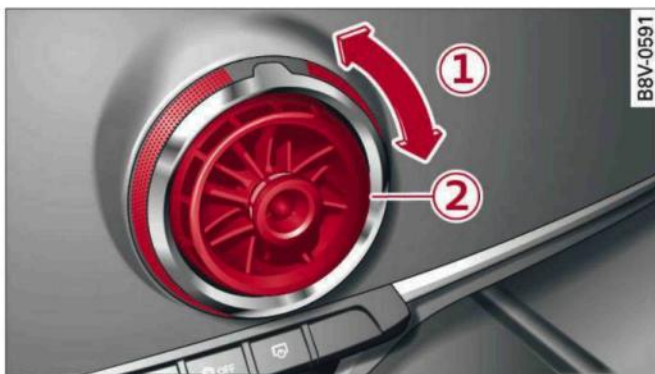

Fig. 67 Dashboard: Adjusting air outlet

The following settings are possible ⇒ Fig. 67:

- ① Air flow intensity
- ② Air flow direction

To adjust the **air flow intensity**, turn the ribbed outer adjustment ring ① ⇒ Fig. 67. To shut off the air flow, turn the adjustment ring all the way to the right.

To adjust the **air flow direction**, move the inside grille ② in the air outlet.

## Driving

### General notes

#### Running in

A new vehicle should be run in over a distance of 1,500 km. For the first 1,000 km the engine speed should not exceed 2/3 of the maximum permissible engine speed – do not use full throttle and do not tow a trailer or caravan. From 1,000 to 1,500 km you can gradually increase the engine rpm and road speed.

During its first few hours of running, the internal friction in the engine is greater than later on when all the moving parts have bedded down.

How the vehicle is driven for the first 1,500 km also influences the engine quality. After this period you should continue driving at moderate engine speeds, in particular when the engine is cold. This helps to reduce wear and tear on the engine and increases the potential mileage which can be covered by the engine.

You should also avoid driving with the engine speed too *low*. Change down to a lower gear when the engine no longer runs “smoothly”. Excessively high engine speeds are prevented by an automatic rev limiter.

#### Avoiding damage to the car

##### CAUTION

Take care not to damage low-mounted parts of the car (such as the spoiler or exhaust system) on steep ramps, uneven road surfaces or roadside kerbs, etc. This applies especially to vehicles with low ground clearance and to all vehicles when fully laden.

#### Driving through water on roads

Please note the following in order to prevent damage to the vehicle when driving through water (e.g. on flooded roads):

- The water level must not be higher than the vehicle's underbody.
- Do not drive faster than walking pace.

##### WARNING

After driving through water, mud, sludge, etc., the braking effect can be delayed slightly due to moisture on the discs and brake pads. Applying the brakes carefully several times will remove the moisture and restore the full braking effect.

##### CAUTION

- Parts of the vehicle (e.g. engine, gearbox, running gear or electrical components) can be badly damaged when driving through water.
- Always switch off the start/stop system\*  
⇒ *page 79* before driving through water.

##### Note

- It is advisable to check the depth at the deepest point before approaching the water.
- Do NOT stop the vehicle, drive in reverse or switch off the engine before you are out of the water.
- Bear in mind that waves created by oncoming traffic could exceed the permissible wading depth of your vehicle.
- Avoid driving through salt water (corrosion).

#### How to improve economy and minimise pollution

Fuel economy, environmental impact and wear on the engine, brakes and tyres depend largely on the way you drive the vehicle. By adopting an economical driving style and anticipating the traffic situation ahead, you can reduce fuel consumption by 10 - 15 %. The following section gives you some tips on lessening the impact on the environment and reducing your operating costs at the same time.

##### Anticipate well in advance

A car uses most fuel when accelerating. If you anticipate hazards and speed changes well in advance, you will need to brake less and thus accelerate less. Wherever possible, let the car slow down gradually **with a gear engaged**, for

instance when you can see that the next traffic lights are red. This takes advantage of the engine braking effect, reducing wear on the brakes and tyres. Emissions and fuel consumption will drop to zero due to the overrun fuel cut-off.

### Change gear early to save fuel

An effective way of saving fuel is to *change up quickly* through the gears. Running the engine at high rpm in the lower gears uses an unnecessary amount of fuel.

Applies to: vehicles with manual gearbox

Shift up to second gear as soon as possible. If possible, we recommend shifting up to the next gear at approx. 2,000 rpm.

Applies to: vehicles with automatic gearbox

Press the accelerator slowly and avoid using the “kick-down” feature.

### Avoid driving at high speed

Avoid travelling at top speed. Fuel consumption, exhaust emissions and noise levels all increase very rapidly at higher speeds. Driving at moderate speeds will help to save fuel.

### Do not let the engine idle for longer than necessary

Engine idling periods are automatically reduced on vehicles with start/stop system\*. On vehicles without a start/stop system, it is worthwhile switching off the engine at level crossings, for instance, or at traffic lights with a long red phase. The fuel saved after about 5 seconds can be greater than the amount of fuel needed to restart a warm engine (the exact fuel saving depends on the engine version).

The engine takes a very long time to warm up when it is running at idling speed. Mechanical wear and pollutant emissions are also especially high during this initial warm-up phase. It is therefore best to drive off immediately after starting the engine. Avoid running the engine at high speed.

### Regular servicing

Regular servicing can establish a basis for good fuel economy before you start driving. A well-

serviced engine gives you the benefit of **improved fuel efficiency** as well as maximum reliability and an enhanced resale value. A poorly maintained engine can consume up to ten per cent more fuel than necessary.

### Avoid short trips

The engine and emission control system need to reach their **proper working temperature** in order to minimise fuel consumption and emissions.

A cold engine uses disproportionately more fuel. The engine only reaches its working temperature after about four kilometres, when fuel consumption will return to a normal level.

### Check tyre pressures

Always make sure the tyres are inflated to the correct pressures ⇒ *page 306* to save fuel. If the tyre pressures are just 0.5 bar too low, this can increase the fuel consumption by as much as 5 %. Due to the greater rolling resistance, under-inflation also increases **tyre wear** and impairs handling.

Do not use **winter tyres** all through the year; they will increase fuel consumption by up to 10 %.

### Avoid carrying unnecessary loads

Every kilo of **extra weight** will increase the fuel consumption, so it is worth checking the luggage compartment occasionally to make sure that no unnecessary loads are being transported.

The roof carrier increases the air resistance of the vehicle and should be removed when not in use. This will save about 12 % of fuel at speeds of between 60 and 75 mph.

### Save electrical energy

The engine drives the alternator to generate electricity. This means that fuel consumption rises when more power is required for electrical equipment. Switch off electrical equipment when it is not needed. Electrical equipment which uses a lot of electricity includes the blower (at a high setting), the rear window heating and the seat heating\*.

## Steering

### Adjusting the steering wheel position

The height and reach of the steering wheel can be adjusted as required to suit the driver.

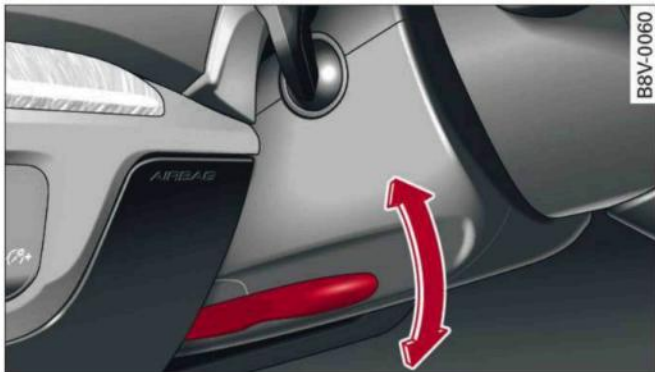

Fig. 68 Steering column: Lever for steering column adjustment

- ▶ Push the lever ⇒ Fig. 68 down ⇒ ⚠.
- ▶ Move the steering wheel to the desired position.
- ▶ Then push the lever towards the steering column until the catch engages.

#### ⚠ WARNING

- Never adjust the position of the steering wheel when the vehicle is moving – this could cause an accident.
- Press the lever upwards so it is secure and so that the position of the steering wheel cannot shift unexpectedly while the vehicle is moving – risk of accident!

## Starting and stopping the engine (vehicles with ignition lock)

### Starting the engine

Applies to: vehicles with ignition lock

Insert the key in the ignition lock to switch on the ignition and start the engine.



Fig. 69 Ignition lock: Ignition key positions

### Switching the ignition on/off

- ▶ To switch on the ignition, turn the ignition key to position ①. Vehicles without start/stop system\*: The rev counter needle will move to the **READY** position.
- ▶ To switch off the ignition, turn the ignition key to position ②. The rev counter needle will move to the **OFF** position.

Diesel engines are automatically preheated when you switch on the ignition.

### Starting the engine

- ▶ Manual gearbox: Press the clutch pedal all the way down and move the gear lever into neutral.
- ▶ Automatic gearbox: Press the brake pedal and move the selector lever to position P or N.
- ▶ Turn the ignition key briefly to position ②. The ignition key automatically returns to position ①. Do not press the accelerator.

Applies to: vehicles with diesel engine

- ▶ The engine may take a few seconds longer than usual to start on cold days. Please keep your foot on the clutch pedal (manual gearbox) or brake pedal (automatic gearbox) until the engine starts. The indicator lamp  lights up while the glow plugs are preheating. ▶

Electrical components with a high power consumption are switched off temporarily while you start the engine.

If the engine fails to start immediately, switch off the starter by turning the ignition key to position ① and try again after about 30 seconds.

### Start/stop system\*

Please note the information on ⇒ page 79, *Start/stop system*.

#### WARNING

- Never run the engine in confined spaces. The exhaust gases are toxic – risk of poisoning!
- Never remove the key from the ignition while the vehicle is moving. The steering lock would engage, and you would not be able to steer the car – risk of accident!

#### CAUTION

Avoid high engine speeds, full throttle and extreme load conditions until the engine has reached its normal operating temperature; otherwise this can damage the engine.

#### For the sake of the environment

Do not warm up the engine by running it with the car stationary. You should drive off immediately whenever possible. This will help avoid unnecessary exhaust emissions.

#### Note

- If it is difficult to turn the ignition key to position ①, move the steering wheel (to take the load off the steering lock mechanism) until the key turns freely.
- Any noises which may be heard when the engine is started are quite normal and no cause for concern.

### Switching off the engine

Applies to: vehicles with ignition lock

#### Switching off the engine

- ▶ Stop the vehicle.

- ▶ Turn the ignition key to position ①. The rev counter needle will move to the **OFF** position.

#### Engaging the steering lock

Important: The selector lever must be in position P (automatic gearbox\*).

- ▶ Remove the ignition key while it is in position ① ⇒ page 76, Fig. 70 ⇒ .
- ▶ Turn the steering wheel until you hear the steering lock engage.

The steering lock acts as a theft deterrent.

#### WARNING

- Never switch off the engine until the vehicle is stationary. Otherwise you may not have the full benefit of the brake servo and power steering. You may need more strength to steer and brake the vehicle than you normally would. This would mean a greater risk of accidents and serious injury, because you cannot steer and brake in the normal manner.
- Never remove the key from the ignition while the vehicle is moving. The steering lock could engage suddenly, and you would not be able to steer the car.
- Always take the key with you when you leave the vehicle. Otherwise the engine can be started or power-operated equipment such as the electric windows can be used. This could result in serious injury.
- When parking, always move the selector lever to position P to prevent the vehicle from rolling back accidentally.

#### CAUTION

If the engine has been working hard for a long time, there is a risk of heat building up in the engine compartment after the engine has been switched off; this could cause engine damage. For this reason, you should leave the engine idling for about 2 minutes before switching it off. ▶

**i Note**

After the engine is stopped, the radiator fan may remain on or turn itself back on for up to 10 minutes, even if the ignition is switched off. This may occur for the following reasons:

- Residual heat has raised the coolant temperature.
- Direct sunlight has additionally heated up the engine compartment while the engine is warm.
- Applies to vehicles with diesel particulate filter: The emission control system is hot because of the regeneration process, even though the engine has not yet reached operating temperature.

## Starting and stopping the engine (vehicles with convenience key)

### Starting the engine

Applies to: vehicles with convenience key

You can use the **START ENGINE STOP** button to switch on the ignition and start the engine.



Fig. 70 Centre console: START ENGINE STOP button

### Starting the engine

- ▶ Manual gearbox: Press the clutch pedal all the way down and move the gear lever into neutral.
- ▶ Automatic gearbox: Press the brake pedal and move the selector lever to position P or N.
- ▶ Press the **START ENGINE STOP** button briefly to start the engine.

Applies to: vehicles with diesel engine

- ▶ The engine may take a few seconds longer than usual to start on cold days. Please keep your foot on the clutch pedal (manual gearbox) or

brake pedal (automatic gearbox) until the engine starts. The indicator lamp  lights up while the glow plugs are preheating.

Electrical components with a high power consumption are switched off temporarily while you start the engine.

If the engine fails to start immediately, switch off the starter by pressing the **START ENGINE STOP** button once more and try again after about 30 seconds.

### Switching the ignition on/off

If you only wish to switch on the ignition and do not want to start the engine as well, proceed as follows:

- ▶ Press the **START ENGINE STOP** button **without** pressing the clutch (manual gearbox) or brake pedal (automatic gearbox). Vehicles without start/stop system\*: The rev counter needle will move to the **READY** position.
- ▶ To switch off the ignition, press the button again. The rev counter needle will move to the **OFF** position.

Diesel engines are automatically preheated when you switch on the ignition.

If the indicator lamp  flashes and the message **Please move steering wheel** appears when you switch on the ignition, the steering wheel is locked. In this case, turn the steering wheel slightly to the left/right.

### Start/stop system\*

Please note the information on [⇒ page 79](#), *Start/stop system*.

#### **WARNING**

Never run the engine in confined spaces. The exhaust gases are toxic – risk of poisoning!

#### **CAUTION**

Avoid high engine speeds, full throttle and extreme load conditions until the engine has reached its normal operating temperature; otherwise this can damage the engine.

**For the sake of the environment**

Do not warm up the engine by running it with the car stationary. You should drive off immediately whenever possible. This will help avoid unnecessary exhaust emissions.

**Note**

- Any noises which may be heard when the engine is started are quite normal and no cause for concern.
- If you leave your vehicle with the ignition switched on, it will be switched off automatically after a while. Please note that electrical equipment such as the exterior lighting will also be switched off.

**Switching off the engine**

Applies to: vehicles with convenience key

- ▶ Stop the vehicle.
- ▶ Automatic gearbox: Move the selector lever to position P.
- ▶ Press the **START ENGINE STOP** button  
⇒ page 76, Fig. 70.

**Steering lock<sup>1)</sup>**

The steering will be locked if you switch off the engine with the **START ENGINE STOP** button, move the selector lever to position P (on vehicles with automatic gearbox\*) and open the driver's door. The steering lock acts as a theft deterrent.

**Emergency Off function**

If necessary in an emergency, the engine can be switched off while the vehicle is still moving at speeds of 7 km/h and above. To switch off the engine, press the **START ENGINE STOP** button twice in quick succession or hold it in for longer than two seconds.

**WARNING**

- Never switch off the engine until the vehicle is stationary. Otherwise you may not have the full benefit of the brake servo and power steering. You may need more strength to

steer and brake the vehicle than you normally would. This would mean a greater risk of accidents and serious injury, because you cannot steer and brake in the normal manner.

- Always take the key with you when you leave the vehicle. Otherwise the engine can be started or power-operated equipment such as the electric windows can be used. This could result in serious injury.
- When parking, always move the selector lever to position P to prevent the vehicle from rolling back accidentally.

**CAUTION**

If the engine has been working hard for a long time, there is a risk of heat building up in the engine compartment after the engine has been switched off; this could cause engine damage. For this reason, you should leave the engine idling for about 2 minutes before switching it off.

**Note**

After the engine is stopped, the radiator fan may remain on or turn itself back on for up to 10 minutes, even if the ignition is switched off. This may occur for the following reasons:

- Residual heat has raised the coolant temperature.
- Direct sunlight has additionally heated up the engine compartment while the engine is warm.
- Applies to vehicles with diesel particulate filter: The emission control system is hot because of the regeneration process, even though the engine has not yet reached operating temperature.

**Driver messages**

**Engine running. Warning! Switch off ignition before leaving car** ▶

<sup>1)</sup> This function is not available on all export versions.

This message appears and a buzzer sounds if you open the driver's door while the engine is running.

### **Pressing start/stop button again will switch off engine.**

This message appears if you press the **START ENGINE STOP**\* button while the vehicle is moving ⇒ *page 77, Emergency Off function.*

### **Engine start system: fault. Please contact workshop**

A fault has occurred when starting the engine automatically (automatic start function). Drive to a qualified workshop soon and have the fault rectified. To start the engine, turn the ignition key to position ② ⇒ *page 74* or press the **START ENGINE STOP** button and hold the key/button until the engine starts.

### **Key not recognised. See owner's manual**

This message appears if there is no convenience key inside the vehicle or if the system cannot detect or identify the key. This can happen, for example, if the radio signal from the key is *obstructed* by a metal briefcase or similar, or if the key battery is weak. Electronic equipment, such as mobile phones, can also interfere with the radio signal from the key.

The engine can still be started or stopped if this happens (please refer to ⇒ *page 79*).

### **Remote control key: hold back of key against marked area. See owner's manual**

If the indicator lamp lights up and the message appears, a malfunction has occurred ⇒ *page 79*.

### **Key not in vehicle?**

### **Remote control key: key not recognised. Is key still in vehicle?**

If the indicator lamp  lights up and the message appears, the convenience key was removed from the vehicle while the engine was running. If the convenience key is not in the vehicle you will not be able to switch on the ignition or restart the engine after it has been switched off. You will

also not be able to lock the vehicle from the outside.

### **Please press brake pedal**

This message appears on vehicles with an automatic gearbox if you try to start the engine without first pressing the brake pedal.

### **Please press clutch pedal**

This message appears if you try to start the engine without first pressing the clutch pedal. The engine will only start if you press the clutch pedal.

### **Please engage N or P**

This message will appear if you try to start or switch off the engine when the selector lever is not in N or P. The engine can then not be started or switched off.

### **Switch off ignition before leaving car. Battery is being discharged**

This message appears and the buzzer sounds if you open the driver's door while the ignition is switched on. Switch off the ignition to prevent the vehicle battery from being discharged.

### **Shift to P, vehicle can roll away. Doors can only be locked in P**

For safety reasons, this message will appear if the selector lever of the automatic gearbox is not in position P when you switch off the ignition. Put the selector lever in position P; otherwise the vehicle can roll away and cannot be locked.



## Starting the engine after a malfunction



Applies to: vehicles with convenience key

If the remote control key battery is exhausted or if radio interference or a system malfunction occurs, extra steps may be necessary in order to start the engine.



Fig. 71 Steering column/remote control key: Starting the engine after a malfunction

If the message  **Key not recognised. See owner's manual** or  **Remote control key: hold back of key against marked area. See owner's manual** is displayed, you can still start the engine manually.

- ▶ Manual gearbox: Press the clutch pedal.
- ▶ Automatic gearbox: Press the brake pedal.
- ▶ Hold the remote control key against the symbol  ⇒ Fig. 71, as shown in the illustration.
- ▶ Press the **START ENGINE STOP** button ⇒  in *Starting the engine on page 76*. The engine should start.
- ▶ Drive to a qualified workshop soon and have the fault rectified.

### Note

You can call up the driver message again by pressing the **START ENGINE STOP** button.

## Start/stop system

### Description

Applies to: vehicles with start/stop system

The start/stop system can help to save fuel and reduce CO<sub>2</sub> emissions.

In start/stop mode, the engine is switched off automatically when the vehicle stops, e.g. at traffic lights. The ignition remains on during this stop phase. The engine is automatically started on demand.

The start/stop system is automatically activated each time you switch on the ignition.

### Basic conditions for start/stop mode

- The driver's door must be closed.
- The driver's seat belt must be buckled.
- The bonnet must be closed.
- The vehicle must have been moving at over 3 km/h since the last stop.

### CAUTION

Always switch off the start/stop system ⇒ *page 81* before driving through water.

### Note

The engine is switched off<sup>1)</sup> shortly before the vehicle comes to a stop. However, the brake servo and power steering remain fully operational.



## Stopping/starting the engine

Applies to: vehicles with start/stop system



Fig. 72 Instrument cluster: Engine switched off (stop phase)

Applies to: vehicles with manual gearbox



- ▶ When the vehicle stops, put the gear lever in neutral and take your foot off the clutch pedal. The engine will switch off. An indicator lamp  /  will light up in the instrument cluster ▶

<sup>1)</sup> May vary in different countries

display. The rev counter needle will also move to the **READY** position.

- ▶ The engine will start again automatically when you press the clutch pedal. The indicator lamp will go out.

Applies to: vehicles with automatic gearbox

- ▶ Brake the vehicle to a stop. The engine will be switched off shortly before the vehicle comes to a standstill or when the vehicle is stationary<sup>1)</sup>. Keep your foot on the brake pedal. The indicator lamp /  will appear on the display. The rev counter needle will also move to the **READY** position.
- ▶ The engine will start again automatically when you take your foot off the brake pedal. If the parking brake is applied or hold assist\* is switched on, the engine will only restart when you press the accelerator pedal<sup>1)</sup>. The indicator lamp will go out.

### Further information for automatic gearboxes

The engine will stop if the selector lever is in position P, N or D.

The engine will start again if you move the selector lever to R during a stop phase.

If you do not want the engine to start when moving the selector lever through R, move the lever to P quickly.

You can control whether or not the engine is switched off by varying the amount of pressure on the brake pedal. For instance, if you brake gently in stop-and-go traffic or before turning off at a junction, the engine will remain on while the vehicle is at a standstill. As soon as you press the brake pedal harder, the engine will be switched off.

#### Note

- Keep your foot on the brake pedal during a stop phase to prevent the vehicle from moving.
- If you press the **START ENGINE STOP** button\* during a stop phase, the ignition will

be switched off. The rev counter needle will move to the **OFF** position.

#### Note

Applies to: vehicles with manual gearbox

If the engine stalls, you can start it again directly by pressing the clutch pedal immediately.

### General notes

Applies to: vehicles with start/stop system

#### Engine does not switch off

The system checks that certain conditions are met before and during each stop phase. If the indicator lamp  appears on the instrument cluster display, the engine will not be switched off in the following situations:

- The engine has not yet reached the minimum temperature required for start/stop mode.
- The interior temperature selected on the air conditioner\* has not yet been reached.
- The exterior temperature is very high/low.
- The windscreen is being defrosted .
- The parking aid\* is switched on.
- The vehicle battery charge is too low.
- The steering wheel is close to full lock or the vehicle is being steered.
- Reverse gear has just been selected.
- The vehicle is on a steep gradient.
- At high altitudes.

#### Engine cuts in again automatically

The stop phase is interrupted in the following situations, for example. The engine cuts in automatically without intervention from the driver.

- The vehicle starts to roll (e.g. on a hill).
- The interior temperature deviates from the air conditioner setting.
- The windscreen is being defrosted .
- The brake pedal is pressed several times in succession.
- The vehicle battery charge drops to an insufficient level. ▶

<sup>1)</sup> May vary in different countries

– The power consumption is high.

The engine switches off again when the conditions for start/stop mode are once again fulfilled<sup>1)</sup>.

### Ignition is switched off automatically

To prevent the vehicle battery from being discharged, the ignition will be switched off **automatically** if certain conditions are met. For instance:

- The start/stop system has switched off the engine.
- The vehicle is stationary.
- The driver has left the vehicle.

If the dipped beam headlights are switched on in this case, the side lights will be turned on instead. After approx. 30 minutes, or when you lock the vehicle, the side lights will be switched off.

If the start/stop system has not stopped the engine or if you have switched off the start/stop system manually, the engine will continue running and the ignition will not be switched off automatically ⇒ ⚠.

#### ⚠ WARNING

Never run the engine in confined spaces. The exhaust gases are toxic – risk of poisoning!

#### i Note

If you select D or N after selecting reverse gear on a vehicle with automatic gearbox, the car must have been moving at over 10 km/h before the system can switch off the engine again.

### Switching the start/stop system on/off manually

Applies to: vehicles with start/stop system

*You can switch the system off manually if you don't want to use it.*



Fig. 73 Centre console: Switch for start/stop system

- ▶ To switch the start/stop system off or on manually, press the  button. The LED in the button will light up when the system is switched off.

#### i Note

If you switch off the system during a stop phase, the engine will start again automatically.

### Driver messages in the instrument cluster display

Applies to: vehicles with start/stop system

#### Automatic start/stop deactivated: Please restart engine manually

This message appears if certain conditions have not been met during the stop phase and the start/stop system **cannot** start the engine again automatically. In this case, the engine must be started manually.

#### Automatic start/stop: system fault! Function unavailable

There is a malfunction in the start/stop system. Drive to a workshop soon and have the fault rectified.

<sup>1)</sup> May vary in different countries

## Electro-mechanical parking brake

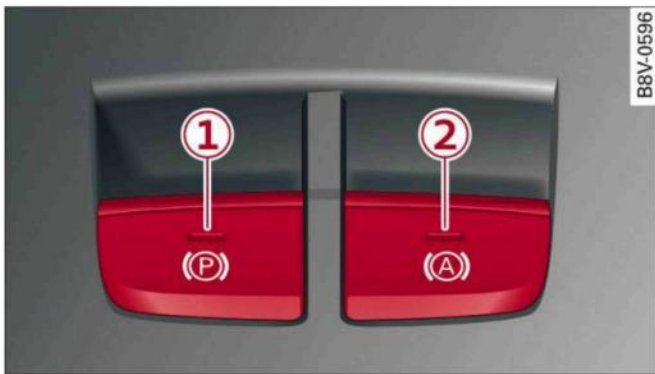

Fig. 74 Centre console: Button for parking brake and hold assist\*

Your vehicle is equipped with an electro-mechanical parking brake ① ⇒ Fig. 74. The parking brake replaces the conventional handbrake, and is mainly intended to prevent the vehicle from rolling away accidentally.

### Applying/releasing the parking brake manually

- ▶ To apply the parking brake, pull the button (P). The LED in the button will light up. In addition, the warning lamp (P) will light up in the instrument cluster.
- ▶ To release the parking brake manually, press the brake or accelerator pedal with the ignition switched on and simultaneously press the button (P). The LED in the button and the warning lamp on the display will go out.

### Releasing the parking brake automatically

Important: The parking brake must be applied and the driver's door must be closed.

- ▶ Accelerate in the usual way to drive off and release the parking brake automatically.

Further features and safety functions are available for driving off, in addition to the automatic parking brake release function ⇒ page 83, *Driving away from a standstill*.

### Preventing the parking brake from being released automatically

In certain situations, e.g. on a steep hill or when towing a trailer, you may wish to prevent the vehicle from rolling back.

- ▶ To prevent the parking brake from being released automatically, pull and hold the button (P) while you press the accelerator. The parking brake will remain engaged and prevent any tendency to roll back down the slope.
- ▶ You can release the button (P) as soon as the engine is delivering enough power to the wheels.

### Emergency braking function

You can use the emergency braking function in emergencies or if the main brake system fails or the pedal is obstructed.

- ▶ Pull and hold the button (P).
- ▶ The brakes will be released immediately if you release the button (P) or press the accelerator.

If you pull and hold the button (P) while the vehicle is moving, this will initiate an emergency brake application. The brakes are then applied hydraulically at all four wheels. The effect is similar to heavy braking ⇒ ⚠.

To prevent the emergency braking function from being used accidentally, a warning buzzer sounds when the button (P) is operated. The brakes are released immediately when you release the button (P) or press the accelerator.

### Parking the car

- ▶ Press the brake pedal to bring the vehicle to a stop.
- ▶ To apply the parking brake, pull the button (P).
- ▶ Automatic gearbox: Move the selector lever to position P.
- ▶ Switch off the engine ⇒ ⚠.
- ▶ Manual gearbox: Engage first gear.
- ▶ When parking on a hill or gradient, turn the steering wheel so that the vehicle would roll into the kerb if it did start to move accidentally.

#### ⚠ WARNING

- Take care never to press the accelerator pedal or release the clutch inadvertently if a gear is engaged or if the selector lever is not in position P or N (on automatic vehicles) while the vehicle is stationary with the engine running. The vehicle will otherwise

start moving immediately and could cause an accident.

- You should only use the emergency braking function in a real emergency, for example if the brake system were to fail or if the brake pedal were to be obstructed. If you use the emergency braking function by activating the parking brake switch, this has the same effect as heavy braking. Please remember that the ESC (and the integrated ABS, EDL and traction control functions) is still subject to certain physical limits. In a corner or in bad road or weather conditions an emergency stop can cause the vehicle to skid or lose steering control.
- It is not possible to apply the parking brake if the electrical power supply fails. In this case, park the vehicle on a level surface and select 1st gear (manual gearbox) or move the selector lever to position P (automatic gearbox) to prevent it from rolling. Obtain professional assistance.
- Always take the key with you when leaving your vehicle - even if you only intend to be gone for a short time. This is especially important if children are left in the car. They might otherwise be able to start the engine, release the parking brake or use power-operated equipment such as the electric windows - this could lead to injuries.
- Do not leave anyone (especially children) in the vehicle when it is locked. Locked doors could delay assistance in an emergency, potentially putting lives at risk.

### Note

Applies to: vehicles with automatic gearbox

You can apply the parking brake manually or switch on the hold assist\* when stopping at traffic lights, etc. You do not then have to hold the car with the brake pedal, as the brakes will stop it creeping forward while a gear is engaged in the automatic transmission. When you drive off in the normal way, the parking brake will be released automatically and your vehicle will start moving ⇒ page 83.

### Note

- Any slight noise which may be heard when the parking brake is applied or released is quite normal and no cause for concern.
- The parking brake runs an automatic test cycle at regular intervals when the vehicle is parked. This may cause a slight noise, which is normal.
- If the electrical power supply fails, it is not possible to release the parking brake (if it was applied) or to apply the parking brake (if it was released) ⇒ . Obtain professional assistance.

## Driving away from a standstill

Various features and safety functions are available for driving off, depending on the equipment in your vehicle.

### Hill starting with the parking brake applied

Important: The driver's door must be closed.

- ▶ To drive off more easily on a slope, apply the parking brake and drive off just as you usually would. The parking brake will be released automatically, but not until there is enough power at the wheels to make the vehicle move in the desired direction.

### Hill starting with the hill hold assist

The hill hold assist function makes it easier to drive away on a slope.

Important: The driver's door must be closed and the engine must be running.

- ▶ To activate the hill hold assist, press and hold the brake pedal for several seconds. The vehicle must be on a slope and facing uphill.

When you release the brake pedal the braking force will be maintained for a moment ⇒  in order to hold the vehicle and make it easier for you to drive away. ▶

### Driving off with the hold assist

Applies to: vehicles with hold assist

The hold assist helps the driver if the vehicle is stationary for a long period or very often, for instance at traffic lights, on steep gradients or in stop-and-go traffic.

Important: The driver's door must be closed and the engine must be running.

- ▶ To switch the hold assist on/off, press the button (A) ② ⇒ page 82, Fig. 74, ⇒ ⚠. The LED in the button will light up or go out.
- ▶ Once it detects that the vehicle has stopped, the hold assist keeps the vehicle stationary. In this case, a green indicator lamp (P) lights up in the instrument cluster. You can now take your foot off the brake pedal.
- ▶ Drive off in the normal way: the brake will be released automatically and the vehicle will start moving.

In certain situations, the hold assist transfers the job of holding the vehicle to the parking brake. As soon as the parking brake is holding the vehicle still, the warning lamp (P) appears in the instrument cluster. In addition, the LED in the (P) button will light up.

### Driver messages in the instrument cluster display

#### Ⓜ Hold assist: unavailable

If this message appears, the hold assist is unavailable or the system requirements have not been met.

#### ⚠ WARNING

Applies to: vehicles with hill hold assist

If you do not drive away immediately after releasing the brake pedal, or if the engine stalls, the vehicle could start to roll back. You should therefore immediately press the brake pedal or apply the parking brake.

#### ⚠ WARNING

The intelligent technology in the hold assist\* and hill hold assist functions cannot defy the laws of physics. Do not let the extra convenience afforded by the hold assist\* and hill

hold assist functions tempt you into taking any risks when driving – this can cause accidents.

- The hold assist\* and hill hold assist functions cannot keep the vehicle stationary in all conditions on a gradient (e.g. if the road is slippery or icy).
- Always ensure that the vehicle is stopped properly and safely – risk of accident!

#### ⚠ CAUTION

Switch off the hold assist\* function before driving the vehicle into a car wash.

#### i Note

Applies to: vehicles with automatic gearbox

When the hold assist\* function is switched on, it stops the vehicle from creeping forwards when you take your foot off the brake pedal.

## Off-road driving

### General notes

The functions of the electronic stabilisation control (ESC) have been augmented to provide extra assistance when driving off-road. The ESC off-road mode can be activated in situations when it would be advantageous for the wheels to lock, or when a differential lock would normally be required ⇒ page 146.

**This Audi model is not an off-road vehicle, however. When driving off-road you are advised to avoid tracks or terrain which are not suited to the design of the car and your own driving skills and experience. Do not take any risks.**

### After driving off-road

- After driving, remove any pieces of foliage or other objects which may be caught in the radiator grille, under the car or in the wheels. In particular, inspect the tyre treads for stones.
- Clean the bodywork and underside of the vehicle and check the underside for possible damage.
- Remove dirt from the windows, headlight lenses and number plates.

- Check that the brakes work properly (especially after driving through water).

### WARNING

- You should exercise particular care when driving on difficult road surfaces, and try to anticipate hazards in advance. Excessive speed or careless manoeuvres can result in personal injury or damage to the vehicle.
- Always adjust your speed to suit the terrain or road surface and weather or traffic conditions. Drive extra slowly when visibility is limited by uneven terrain.
- Please note that there can be an increased tendency for the wheels to spin in ESC off-road mode, causing the vehicle to lose grip, in particular on slippery or wet roads – danger of skidding!
- The car's stability is restricted in ESC off-road mode.

### For the sake of the environment

Take care not to damage the environment and respect natural surroundings.

### Note

Only drive where access by motor vehicles is permitted and keep to the marked tracks and routes.

## Driving tips

*When driving on rough tracks always drive slowly and be aware of possible hazards.*

Please observe the following precautions if you drive the vehicle on unsurfaced tracks or off-road:

- ▶ When driving off-road you are advised to avoid tracks or terrain which are not suited to the design of the car and your own driving skills and experience. Do not take risks.
- ▶ Drive slowly and be ready for possible hazards.
- ▶ Be aware of the maximum **ground clearance** of your vehicle. The figure in actual conditions may be different, depending on the type of surface, the surrounding terrain and the load being carried. With certain types of suspension,

such as sports suspension, the ground clearance is reduced. It is the responsibility of the driver to decide whether or not the vehicle is capable of safely negotiating a particular situation.

- ▶ Activate the **ESC off-road mode** if required  
⇒ *page 146*.

## Unsurfaced tracks

On unfamiliar roads and off-road terrain, drive slowly and be prepared for unexpected obstacles, such as pot-holes, rocks or tree stumps, etc.

To prevent ground contact and possible damage to the underside, do not drive the bottom of your vehicle directly over raised obstacles. Instead, drive the wheels on one side of the car up and across the top of the obstacle.

When driving over sand or soft mud, maintain a moderate speed and avoid stopping if possible.

## Driving through water on roads

Please observe the important safety warnings on  
⇒ *page 72*.

# Automatic gearbox

## Introduction

Applies to: vehicles with automatic gearbox

The automatic gearbox is controlled electronically. The gearbox changes up and down automatically.

When you drive at **moderate speeds** the gearbox will select the most economical shift programme. It will then change up early and delay the downshifts to give better fuel economy.

If you drive at **higher speeds** with heavy acceleration, if you open the throttle quickly, or if you use the kick-down or the car's maximum speed, the gearbox will automatically select the more "sporty" shift programmes when the selector lever is in position S.

If desired, you can also select the gears *manually* (**tiptronic mode**) ⇒ *page 90, Manual gear selection (tiptronic mode)*. ▶

Applies to: vehicles with S tronic gearbox

The S tronic is a dual-clutch gearbox. Torque is transmitted via two independent clutches. They replace the torque converter found on conventional automatic gearboxes and allow for smooth, uninterrupted acceleration of the vehicle.

### Selector lever positions

Applies to: vehicles with automatic gearbox



Fig. 75 Instrument cluster: Selector lever positions

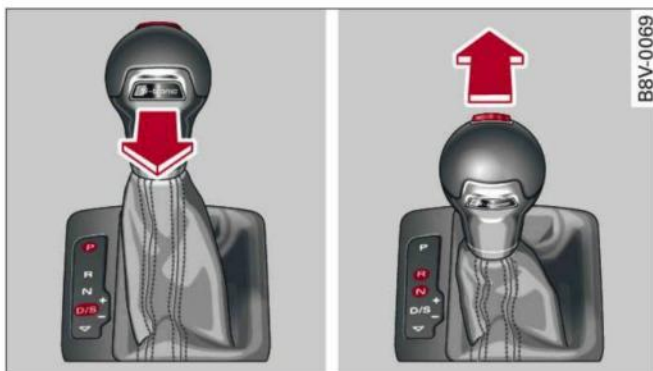

Fig. 76 Selector lever lock

The current selector lever position is shown next to the selector lever ⇒ Fig. 76 and on the instrument cluster display ⇒ Fig. 75. In addition, the current gear is shown on the instrument cluster display.

- ▶ Switch on the ignition.
- ▶ If the selector lever is in position P or N, you will need to release the selector lever lock ⇒ page 86.
- ▶ Move the selector lever to the desired position. The current position is indicated on the selector gate.

### Selector lever lock

The selector lever lock prevents gears from being engaged inadvertently, so that the vehicle is not set in motion unintentionally.

The selector lever is locked in the P and N positions when the ignition is on. To move the selector lever out of positions P and N, the driver must apply the brake pedal and press the interlock button.

The selector lever lock only works if the vehicle is stationary or driving at speeds up to approx. 2 km/h. At higher speeds the selector lever lock in the N position is disengaged automatically.

The selector lever lock is not engaged if the selector lever is moved quickly through position N (e.g. when shifting from R to D). This makes it possible, for instance, to “rock” the vehicle backwards and forwards if it is stuck in snow or mud. The selector lever lock engages automatically if the brake pedal is not depressed and the lever is in position N for more than about two seconds.

### Safety interlock for ignition key\*

Applies to: vehicles with ignition lock

The key can only be withdrawn from the ignition lock with the ignition switched off and the selector lever in position P. When the ignition key is removed, the selector lever is locked in position P.

### P – Parking lock

In this position, the vehicle cannot roll away. The parking lock must only be engaged when the vehicle is *stationary* ⇒ ⚠.

The selector lever lock (the button on the selector lever handle) must be released *and* the brake pedal must be pressed before the selector lever can be moved either into or out of position P.

Should the power supply to the selector lever fail, the selector lever will be locked in position P ⇒ page 93, *Releasing the selector lever manually (left-hand drive vehicles)* or ⇒ page 94, *Releasing the selector lever manually (right-hand drive vehicles)*.



## R – Reverse gear

Reverse gear should only be engaged when the vehicle is *stationary* and the engine is idling ⇒ .

To move the selector lever to position R, release the selector lever lock *and* at the same time press the brake pedal.

## N – Neutral

In this position, the gearbox is in neutral.

## D/S – Drive/Sport (standard position for driving forwards)

In selector lever position D/S, the gearbox can be operated in either the standard drive mode (D) or in sport mode (S). To select sport mode (S), briefly pull the selector lever back. The gearbox will switch back to drive mode (D) if you pull the selector lever again. The selected driving mode is shown in the instrument cluster display.

In the standard **drive mode** (D), the gearbox automatically selects the best gear ratio. This depends on the engine load, the road speed and the driving style.

In **Sport mode** S, the gearbox makes full use of the engine power. When accelerating the gear shifts may be noticeable.

Press the brake pedal when moving the selector lever from N to D/S if the vehicle is stationary or at speeds below 2 km/h ⇒ .

## E – Efficiency\*

In efficiency mode ⇒ *page 131, Audi drive select*, the gearbox selects the next gear at lower engine speeds. Earlier upshifts give improved fuel economy because the full power reserves of the engine are not used.

In this mode, an E is shown on the instrument cluster display instead of a D ⇒ *Fig. 75*.

### WARNING

- The car can roll away even if the ignition is switched off.
- Never move the selector lever to R or P when driving, as this could cause an accident.

- In all selector lever positions (except P) the vehicle must always be held with the foot brake when the engine is running. This is because an automatic gearbox still transmits power even at idling speed, and the vehicle tends to “creep” – risk of accident!
- The accelerator pedal must on no account be pressed inadvertently when a gear is engaged with the vehicle stationary. The vehicle could otherwise start moving immediately (in some cases even if the parking brake is engaged) and possibly cause an accident.
- Do not press the accelerator while selecting a gear with the vehicle stationary and the engine running, as this could cause an accident.
- The driver should never get out of the vehicle when the engine is running and a gear is engaged. If you have to leave your vehicle while the engine is running, you must apply the parking brake and engage the parking lock P.
- To avoid accidents, apply the parking brake and put the selector lever in position P before opening the bonnet and working on the vehicle with the engine running. Please observe the important safety warnings ⇒ *page 295, Working on components in the engine compartment*.

### Note

- Audi drive select: You can select the sport program for gear changes by activating the **dynamic** mode ⇒ *page 131*. The instrument cluster display will show S instead of D.
- If the lever is moved accidentally to N when driving, take your foot off the accelerator and let the engine speed drop to idling before selecting D or S again.
- It is not possible to move the selector lever out of position P if the electrical power supply fails. In this case, the selector lever can be released manually. Left-hand drive vehicles ⇒ *page 93*, right-hand drive vehicles ⇒ *page 94*.

**i Note**

If the selector lever does not lock automatically, a malfunction has occurred. In this case, the power transmission is interrupted to prevent the vehicle from moving unintentionally. Proceed as follows to engage the selector lever lock again:

- Applies to vehicles with 6-speed gearbox: Briefly press the brake pedal.
- Applies to vehicles with 7-speed gearbox: Press the brake pedal. Move the selector lever to position P or N and then select a gear.
- If the vehicle does not move forwards or backwards even though a gear is selected, proceed as follows:
- If the vehicle does not move in the desired direction, the system may have failed to engage the gear correctly. In this case, press the brake pedal and select the gear again.
- If the vehicle still does not move in the desired direction, a system malfunction has occurred. Seek professional assistance and have the system checked.

**General notes on driving an automatic**

Applies to: vehicles with automatic gearbox



Fig. 77 Detail of the centre console: Selector lever with interlock button

**Starting the engine**

- ▶ Move the selector lever to P or N. In the case of low outside temperatures (below -10 °C), the engine can only be started when the selector lever is in position P.

**Driving away from a standstill**

- ▶ Press and hold the brake pedal.

- ▶ Press and hold the interlock button (the button in the selector lever handle), set the selector lever to the desired position (e.g. D) ⇒ page 86 and release the interlock button.
- ▶ Wait for the gearbox to engage the gear (a slight movement can be felt).
- ▶ Release the brake and press the accelerator ⇒ ⚠.

There are several convenient functions to help you drive away on gradients ⇒ page 83.

**Stopping briefly**

- ▶ Press the brake pedal to hold the vehicle when stationary (for instance at traffic lights).
- ▶ Do not press the accelerator.
- ▶ To prevent the vehicle from rolling away, apply the parking brake before moving off on steep gradients ⇒ ⚠ and ⇒ ⚠.
- ▶ As soon as you accelerate as normal, the parking brake will automatically be released and the vehicle will start moving. Important: The driver's door must be closed.

**Stopping/parking the car**

If you open the driver's door while the selector lever is not in position P, the vehicle can roll away. The message **Shift to P, otherwise vehicle can roll away. Doors do not lock if lever is not in P.** appears on vehicles with convenience key\*. A buzzer will also sound.

- ▶ Press and hold the brake pedal ⇒ ⚠.
- ▶ Apply the parking brake.
- ▶ Move the selector lever to P.



In some situations (such as on mountain roads or when towing a trailer or caravan) it can be advantageous to switch temporarily to the manual shift programme so that the gear ratios can be selected manually to suit the driving conditions ⇒ page 90.

On level ground it is sufficient to move the selector lever to P. On a gradient the parking brake should be applied first and the selector lever should be moved to P ⇒ page 82. This reduces the load on the locking mechanism and makes it easier to move the selector lever out of position P.

## WARNING

- The driver should never get out of the vehicle when the engine is running and a gear is engaged. If you have to leave your vehicle while the engine is running, you must apply the parking brake and engage the parking lock P.
- If the engine is running and a gear is engaged (D/S or R) or the vehicle is in “tiptronic” mode, you will need to hold the car with the footbrake. Otherwise, the car will “creep” forwards as the power transmission is not fully interrupted even when the engine is idling.
- The accelerator pedal must on no account be pressed inadvertently when the vehicle is stationary. The vehicle could otherwise start moving immediately (in some cases even if the parking brake is engaged) and possibly cause an accident.
- Do not press the accelerator while selecting a gear with the vehicle stationary and the engine running, as this could cause an accident.
- Never move the selector lever to R or P when driving at normal speeds, as this could cause an accident.
- Before you drive down a steep gradient, reduce the speed and use “tiptronic” to select a low gear.
- Never allow the brake to drag when driving downhill and do not use the brake pedal too often or for long periods. Constant braking will cause the brakes to overheat and will considerably reduce the effectiveness of the brakes. It will increase the braking distance and could cause the brake system to fail.
- To avoid rolling back on gradients always hold the vehicle with the footbrake or parking brake if you have to stop.
- Never attempt to hold the vehicle with the clutch when stopping on a gradient. The clutch is disengaged automatically if it is overloaded and becomes too hot – accident risk! If the clutch is overloaded, the indicator lamp  will light up and a message will appear ⇒ page 92.

## CAUTION

- When you have stopped on a gradient, do not try to stop the vehicle rolling back by accelerating when a gear is engaged. This could cause the automatic gearbox to overheat and become damaged. Apply the parking brake or press the brake pedal in order to prevent the vehicle from rolling back.
- If you allow the car to roll with the selector lever in position N with the engine switched off, the automatic gearbox will be damaged as it will not be lubricated ⇒ page 328, *Tow-starting / towing away*.
- In certain driving and traffic conditions, for instance in stop-and-go traffic, if you have to pull away frequently or if the vehicle creeps forwards over a long distance, the gearbox can overheat and become damaged. If the indicator lamp  or the warning lamp  lights up, stop the vehicle at the first opportunity and let the gearbox cool down ⇒ page 92.

## Note

For safety reasons the parking brake will only release automatically if the driver's door is closed.

## Downhill speed control

Applies to: vehicles with automatic gearbox

*The downhill speed control function helps the driver when driving down steep gradients.*

Downhill speed control is activated on a downhill gradient when the selector lever is in D/S and the driver presses the brake pedal. The gearbox automatically selects a suitable gear for the gradient. The downhill speed control function attempts to maintain the speed at which the vehicle was travelling when the foot brake was applied (subject to the laws of physics and technical limitations of the power train). It may be necessary to adjust the speed again using the foot brake. The downhill speed control can change down to 3rd gear but no further, so it may be necessary to change to tiptronic mode on very steep gradients. In this case, change down manually to 2nd or 1st gear in ►

tiptronic mode to use the engine braking effect and reduce the load on the brakes.

Downhill speed control is deactivated as soon as the road levels out again or you press the accelerator pedal.

On vehicles with cruise control system\*  
⇒ *page 104*, downhill speed control is activated when you set a cruising speed.

**! WARNING**

The downhill speed control function cannot defy the laws of physics and may therefore not be able to maintain a constant speed in certain circumstances. Always be prepared to use the brakes!

### Manual gear selection (tiptronic mode)

Applies to: vehicles with automatic gearbox

*The tiptronic feature allows the driver to also change gear manually.*



**Fig. 78** Centre console: Manual gear selection using selector lever



**Fig. 79** Steering wheel: Manual gear selection with paddle levers\*

### Gear selection with selector lever

The tiptronic mode can be selected either with the vehicle stationary or on the move.

- ▶ From position D/S, push the selector lever to the right into the tiptronic selector gate to activate tiptronic mode. As soon as the automatic gearbox has activated this mode, the letter **M** will appear on the display ⇒ *page 86, Fig. 75*; e.g. **M4** means that the vehicle is in 4th gear.
- ▶ Briefly push the selector lever forwards (+) ⇒ *Fig. 78* to change up a gear.
- ▶ Briefly pull the selector lever back (-) to change down a gear.

### Gear selection with paddle levers\*

You can use the paddle levers when the selector lever is in position D/S or **M** (= tiptronic selector gate).

- ▶ To shift up a gear, briefly pull the paddle lever (+) ⇒ *Fig. 79*.
- ▶ To shift down a gear, briefly pull the paddle lever (-).

If you use the paddle levers when the selector lever is in positions D/S, the gearbox will remain in manual mode for a while. To switch back immediately to automatic mode after changing gears manually, pull the paddle lever (+) ⇒ *Fig. 79* for approximately 1 second.

If you want to use the paddle levers permanently, push the selector lever from position D/S to the right into the tiptronic selector gate.

### Description

The gearbox automatically shifts up or down into the next gear before a critical engine speed is reached.

The gearbox only allows manual gear changes if the engine speed would remain within the permissible range.

### Kick-down feature

Applies to: vehicles with automatic gearbox

*The kick-down feature is designed to give maximum acceleration.*

When the accelerator pedal is pressed right down past the point of resistance at full throttle (kick-down feature), the gearbox will shift down to a lower gear, depending on road speed and engine ▶

speed. The upshift to the next higher gear is delayed until the engine reaches maximum rpm.

### WARNING

Please note that if the road surface is slippery or wet, the kick-down feature could cause the driven wheels to spin, which could result in skidding.

## Coasting mode

Applies to: vehicles with S tronic gearbox and coasting mode

In coasting mode<sup>1)</sup> you can use the vehicle's momentum to freewheel, for instance when approaching a speed restriction in a built-up area. The engine is disengaged from the gearbox. This allows you to save fuel by anticipating the traffic situation ahead.

### Requirements for using coasting mode

- ▶ **Efficiency** mode selected in drive select\*  
⇒ *page 131*.
- ▶ The selector lever must be in position D.
- ▶ Road speed less than approx. 130 km/h.
- ▶ Road relatively level.

### Activating coasting mode

- ▶ Take your foot off the accelerator.

The message<sup>1)</sup> **Coasting** will then appear in the “on-board computer” display. The engine ticks over at idling speed while the vehicle is coasting.

### Stopping coasting mode

- ▶ Press the brake or accelerator pedal or briefly pull the paddle lever ⇒ *page 90, Fig. 79*.

### WARNING

- When coasting mode is activated, there is no engine braking effect and the vehicle does not slow down as quickly as usual or may even pick up speed if you are driving down a slope – risk of accident!
- If other people are using your car, you should draw their attention to the coasting mode.

### Note

- The gear is no longer displayed when you are in coasting mode (e.g. E instead of E7).
- The coasting mode is deactivated temporarily on gradients of 15 % or greater.
- Coasting mode is not available while the cruise control system\* or adaptive cruise control\* is switched on.



## Launch control programme

Applies to: vehicles with S tronic gearbox and launch control programme

*The launch control programme enables maximum acceleration.*

The launch control programme is not available for all engine/gearbox combinations.

Important: The engine must be warm and the steering wheel must be pointing straight ahead.

- ▶ Deactivate<sup>2)</sup> the start/stop system\* ⇒ *page 81*. The LED in the  button will light up.
- ▶ Deactivate<sup>2)</sup> the hold assist\* ⇒ *page 84*. The LED in the button will go out.
- ▶ Press the  button once briefly while the engine is running<sup>3) 4)</sup>.

<sup>1)</sup> Not available for all countries.

<sup>2)</sup> The system does not need to be deactivated on all gearbox versions.

<sup>3)</sup> On vehicles with driver information system, the ESC lamp lights up permanently and the message **Stabilisation control (ESC): offroad. Warning! Restricted stability** appears temporarily in the instrument cluster to indicate the deactivation status.

<sup>4)</sup> Vehicles **without** driver information system: The indicator lamp flashes slowly.

- ▶ Briefly pull the selector lever back from position D/S to select position S, or move the selector lever to the right into the tiptronic gate, or select **dynamic** mode in drive select\*  
⇒ page 131.
- ▶ Press the brake pedal firmly with your left foot and hold it down for at least one second.
- ▶ At the same time, press the accelerator all the way down with your right foot until the engine revs are high and steady.
- ▶ Take your left foot off the brake.

### **WARNING**

- Always adapt your driving style to the traffic conditions.
- Only use the launch control programme when road and traffic conditions permit, and make sure your manner of driving and accelerating the vehicle does not inconvenience or endanger other road users.
- Please note that the driven wheels may start to spin when the off-road mode is switched on, causing the vehicle to lose grip, in particular on slippery or wet roads – danger of skidding!
- When acceleration has been completed, you should deactivate the off-road mode again by briefly pressing the  **OFF** button.

### **Note**

- The gearbox may be hot after you have used the launch control programme. In this case, the programme may not be available for several minutes. The programme will be available again after a cool-down period.
- Accelerating with the launch control programme places a heavy load on all parts of the vehicle. This can result in increased wear and tear.

### **Gearbox malfunction**

Applies to: vehicles with automatic gearbox

#### **Gearbox malfunction! Please stop the vehicle and select P**

There is a malfunction in the gearbox. Park the vehicle safely and do not drive on. Obtain professional assistance.

#### **Gearbox overheating! Please stop the vehicle.**

The gearbox is overheating and could be damaged. Stop the vehicle and let the gearbox cool down with the engine idling and the selector lever in position P. If the warning lamp and the message disappear, drive to a qualified workshop soon and have the fault rectified. Do not drive on if the warning lamp stays on and the message does not disappear. Obtain professional assistance.

#### **Gearbox malfunction: you can continue driving**

Drive to a qualified workshop soon and have the fault rectified.

#### **Gearbox malfunction: no reverse gear (you can continue driving)**

A gearbox malfunction has occurred. The gearbox will switch to the back-up programme. The programme will only move into certain gears or may not be able to shift gears at all. The engine may stall. You can no longer engage reverse gear. Drive to a qualified workshop without delay and have the fault rectified.

#### **Gearbox malfunction: you can continue driving in D until engine off**

Park your vehicle well away from moving traffic. Obtain professional assistance.

#### **Gearbox overheating: please adapt driving style**

You can continue driving at moderate speed. You can resume normal driving if the indicator lamp goes out.

#### **Gearbox: please press brake pedal and select gear again**

If a gearbox malfunction has occurred due to overheating, this message will appear once the gearbox has cooled down again.

## Releasing the selector lever manually (left-hand drive vehicles)

Applies to: vehicles with automatic gearbox

The selector lever can be released manually if the electrical power supply should fail.



Fig. 80 Selector lever: Removing the boot

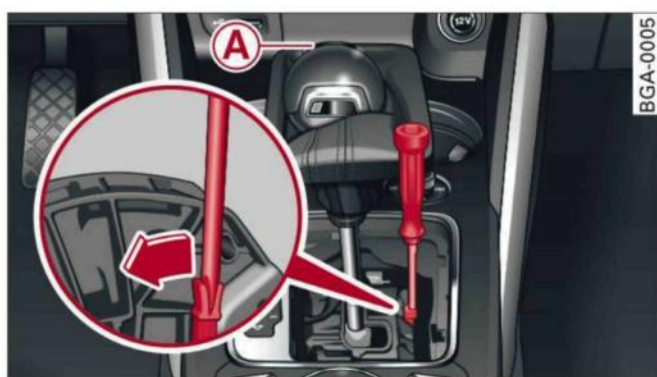

Fig. 81 Manually releasing the selector lever from position P

This section describes how to manually release the selector lever on left-hand drive vehicles.

The selector lever must be manually released from position P in order to move or tow the vehicle.

The manual release mechanism is located on the right underneath the selector gate. Releasing the selector lever requires a certain degree of practical skill. We therefore advise you to obtain professional assistance.

To release the selector lever, you will need the screwdriver from the vehicle's tool kit, which is located in the luggage compartment ⇒ page 319. Use the flat-blade side of the reversible screwdriver insert.

### Removing the selector lever boot

- ▶ Apply the parking brake (P) ⇒ ⚠ to prevent your vehicle from moving. If this is not possi-

ble, use other means to prevent your vehicle from moving.

- ▶ Switch off the ignition.
- ▶ To loosen the selector lever boot, carefully insert the flat-blade side of the screwdriver into the opening at the side of the boot ⇒ Fig. 80.
- ▶ Carefully lever off the boot with the screwdriver and, at the same time, pull the boot upwards -arrow- at the crease with your hand until it is released at all four corners.
- ▶ Fold the boot over the selector lever knob ⇒ Fig. 81.

### Releasing the selector lever manually

- ▶ Insert the screwdriver in the opening for the yellow release lever ⇒ Fig. 81.
- ▶ Using the screwdriver, carefully pull the release lever towards the rear as far as it will go and hold it in this position.
- ▶ Now press the interlock button on the selector lever (A) and move the selector lever to position N.
- ▶ After manually releasing the selector lever make sure you clip the gear lever boot back into the gearshift gate.

### ⚠ WARNING

- Only use the manual release mechanism when the vehicle is on level ground or a slight gradient.
- The selector lever must not be moved out of position P if the parking brake is not applied. If this does not work, use the brake pedal to hold the vehicle or use wheel chocks or similar to block one of the front and rear wheels. If you do not apply the brake, the vehicle may roll away and cause an accident.

### Releasing the selector lever manually (right-hand drive vehicles)

Applies to: vehicles with automatic gearbox

The selector lever can be released manually if the electrical power supply should fail.



Fig. 82 Selector lever: Removing the boot

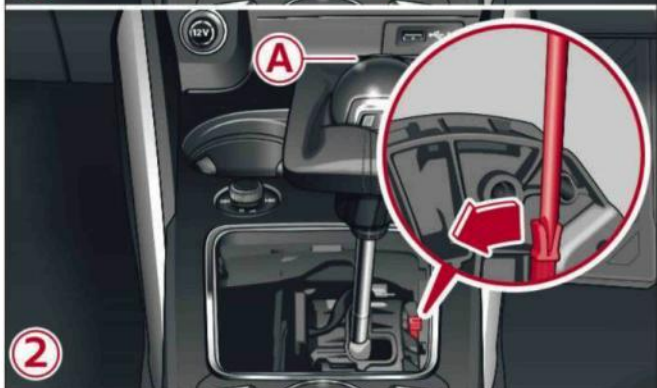

Fig. 83 Manually releasing the selector lever from position P

This section describes how to manually release the selector lever on right-hand drive vehicles.

The selector lever must be manually released from position P in order to move or tow the vehicle.

The manual release mechanism is located on the right underneath the selector gate. Releasing the selector lever requires a certain degree of practi-

cal skill. We therefore advise you to obtain professional assistance.

To release the selector lever, you will need the screwdriver from the vehicle's tool kit, which is located in the luggage compartment ⇒ page 319. Use the flat-blade side of the reversible screwdriver insert.

### Removing the selector lever boot

- ▶ Apply the parking brake (P) ⇒ ⚠ to prevent your vehicle from moving. If this is not possible, use other means to prevent your vehicle from moving.
- ▶ Switch off the ignition.
- ▶ To loosen the selector lever boot, carefully insert the flat-blade side of the screwdriver into the opening at the side of the boot ⇒ Fig. 82.
- ▶ Carefully lever off the boot with the screwdriver and, at the same time, pull the boot upwards -arrow- at the crease with your hand until it is released at all four corners.
- ▶ Fold the boot over the selector lever knob ⇒ Fig. 83.
- ▶ Take out the panel for the selector lever position indicator and let it hang down to one side, suspended by the cable ① ⇒ Fig. 83.

### Releasing the selector lever manually

- ▶ Insert the screwdriver in the opening for the yellow release lever (section ② of ⇒ Fig. 83).
- ▶ Using the screwdriver, carefully pull the release lever towards the rear as far as it will go and hold it in this position.
- ▶ Now press the interlock button on the selector lever (A) and move the selector lever to position N.
- ▶ After manually releasing the selector lever, make sure you fit the panel for the selector lever position indicator back in the selector gate and clip the selector lever boot back into place.

### ⚠ WARNING

- Only use the manual release mechanism when the vehicle is on level ground or a slight gradient.



– The selector lever must not be moved out of position P if the parking brake is not applied. If this does not work, use the brake pedal to hold the vehicle or use wheel chocks or similar to block one of the front and rear wheels. If you do not apply the brake, the vehicle may roll away and cause an accident.

# Towing a trailer

## Driving the vehicle with a trailer or caravan

### Technical requirements

*The towing bracket must comply with certain technical requirements.*

Your car is intended mainly for transporting passengers and luggage. However, if suitably equipped, it can also be used to tow a trailer or caravan.

If the car is supplied with a **factory-fitted** towing bracket it will already have the necessary technical modifications and meet the statutory requirements.

A 13-pin socket is provided to make the electrical connection between the car and the trailer. If the trailer you wish to tow has a **7-pin plug**, the necessary adapter cable can be obtained from a specialist retailer.

If a towing bracket is to be fitted after the car is purchased, this must be done according to the instructions of the towing bracket manufacturer ⇒ *page 102*.

### WARNING

If a towing bracket is retrofitted, the installation should be carried out by a qualified workshop.

- In particular in high outside temperatures it is not possible to drive up long steep gradients without a suitable cooling system. The engine would then overheat.
- Incorrect installation can result in a safety risk.

### Points to check before towing

*There are a number of points which need to be checked before towing a trailer or caravan.*

- ▶ Observe the maximum permitted trailer weights ⇒ *page 342*.

### Trailer weights

Never exceed the maximum permitted trailer weights.

If you do not load the trailer up to the maximum permitted trailer weight, you can then climb correspondingly steeper gradients.

The maximum trailer weights listed are only applicable for **altitudes** up to 1000 m above sea level. With increasing altitude the engine power and therefore the car's climbing ability are impaired because of the reduced air density, so the maximum trailer weight has to be reduced accordingly. The weight of the car and trailer must be reduced by about 10% for every further 1000 m (or part thereof). This figure refers to the combined weight of the (loaded) vehicle and (loaded) trailer.

The figures for the **draw bar weight** that appear on the identification plate of the towing bracket are for certification purposes only. The correct figures for your specific model, which may be *lower* than these figures for the towing bracket, are given in the registration documents and in ⇒ *page 343*.

### Drive select\*

Please note that the **efficiency\*** mode is not available in towing mode.

### Exterior lights

Before starting a journey, make sure that all the lights for the trailer are working properly.

### Distributing the load

Distribute loads in the trailer so that heavy objects are as near to the axle as possible. Loads carried in the trailer must be secured to prevent them slipping. A badly distributed load can also affect handling. This can activate the trailer stabilisation feature and cause the vehicle to reduce speed.

Where possible, operate the trailer with the maximum permitted **draw bar weight** on the ball joint of the towing bracket, but do not exceed the specified limit. ▶

## Tyre pressure

Check the tyre pressures on your car, and adjust for “full load” conditions (refer to the sticker listing the tyre pressures) ⇒ *page 307*. It may also be necessary to adjust the tyre pressures on the trailer according to the recommendations of the trailer manufacturer.

## Exterior mirrors

Check whether you can see enough of the road behind the trailer with the standard mirrors. If this is not the case you should have additional mirrors fitted. Both exterior mirrors should be mounted on hinged extension brackets. Adjust the mirrors to give sufficient vision to the rear.

## Headlights

Before starting a journey, check the headlight beam settings with the trailer hitched up. Adjust the headlight settings if necessary.

On vehicles with halogen headlights, the headlight range control must be adjusted, see ⇒ *page 49*.

The headlight range control will be adjusted automatically if your vehicle is equipped with LED headlights\*.

## Power supply

To ensure that the engine can be started again after the ignition is switched off, the power management system ⇒ *page 149* controls the distribution of electrical power and gradually switches off unnecessary electrical equipment. The trailer is supplied with power during this period. The power supply to the trailer is interrupted while the engine is being started.

## Removable ball joint coupling

Vehicles with a factory-fitted towing bracket are equipped with a *removable* ball joint coupling. This is stored in the spare wheel well or in a separate bag on the floor of the luggage compartment, together with the necessary fitting instructions.

### Note

We recommend having the car serviced between the normal inspection intervals if it used frequently for towing a trailer.

## Trailer stabilisation system

Applies to: vehicles with towing bracket

*Trailer stabilisation helps to reduce the risk of the vehicle skidding when towing a trailer.*

### When is the trailer stabilisation system<sup>1)</sup> activated?

Trailer stabilisation is active when the following requirements are met:

- The ESC must be switched on ⇒ *page 146* and fully functional (no ESC malfunction).
- The trailer connector must be properly secured in the vehicle socket.
- The vehicle speed must be higher than approx. 60 km/h.

### How trailer stabilisation works

In many cases, the driver can stabilise a swaying trailer by manually braking the vehicle.

However, if the ESC detects that the trailer is swaying and this is affecting the towing vehicle, it will automatically brake the vehicle in order to stabilise the trailer. The indicator lamp  will flash in the instrument cluster. If possible, do not turn the steering wheel at this stage.

In order to warn traffic behind you, the brake lights will come on during this automatic braking operation.

A trailer may sway quite considerably without the trailer stabilisation system intervening.

If the system for activating the trailer brake lights is defective, this will be indicated in the instrument cluster display ⇒ *page 35*,  *Bulb monitor*. ▶

<sup>1)</sup> Not available on vehicles for some markets.

### Requirements for correct functioning of the trailer stabilisation system

If these conditions are not met in full, the trailer stabilisation system will only intervene to a limited extent or not at all ⇒ ⚠.

- The electrical connection between the towing vehicle and the trailer must be functioning correctly.
- The load on the trailer must be properly secured.
- The tyre pressures on both the vehicle and the trailer must be adapted to the load that is being carried.
- Where possible, operate the trailer with the maximum permitted draw bar weight.
- The trailer overrun brake must be set correctly. This is important to ensure that the trailer can be braked correctly, to avoid the vehicle and trailer “jack-knifing” and to prevent excess braking of the trailer.
- At low outside temperatures, both the towing vehicle **and** the trailer should be fitted with winter tyres.

#### **WARNING**

It is essential that you adjust your speed to suit the weather, road and traffic conditions. Do not let the trailer stabilisation system tempt you into taking any risks when driving – this can cause accidents.

- The ESC and trailer stabilisation system cannot defy the laws of physics. This should be kept in mind, particularly on slippery and wet roads and when towing a trailer with a light load.
- The trailer stabilisation system is functional, regardless of whether the trailer has a mechanical overrun brake or not.
- The trailer stabilisation system is not always able to detect swaying of trailers with a light load and will therefore not intervene.
- A trailer can still “jack-knife” on slippery roads with little grip, even if the towing vehicle is equipped with the trailer stabilisation system.

- Trailers with a high centre of gravity may even tip over before they start to sway sideways.
- If you are not towing a trailer, but the trailer socket is being used (e.g. for an illuminated bicycle rack), the trailer stabilisation system may be activated in extreme driving conditions.
- Please note the additional information and warnings ⇒ *page 98, Driving tips.*

### Driving tips

*Driving with a trailer always requires extra care.*

#### Weight distribution

Try to avoid towing a loaded trailer with an unladen vehicle. If this cannot be avoided, drive extra slowly to allow for the unbalanced weight distribution.

#### Speed

Normally, you must not exceed 80 km/h when towing a trailer or caravan. However, if the trailer/caravan is equipped with a trailer stabilisation system, you can drive at max. 100 km/h. Please observe any other regulations applicable in the country in which you are travelling.

The stability of the car and trailer is reduced with increasing speed. For this reason it is advisable not to drive at the maximum permissible top speed in unfavourable road, weather or wind conditions. This applies especially on a downhill gradient.

You should always reduce speed immediately if the trailer shows the slightest sign of **swaying**. Never try to stop the swaying by accelerating further.

Always brake in good time. If the trailer has an **overrun brake**, apply the brakes *gently at first* and then firmly. This will prevent the jerking that can be caused by the trailer wheels locking. Change down in good time before going down a steep hill so that you can use the engine braking effect to slow down the vehicle.

Swaying and pitching can be reduced by attaching an extra stabiliser to the trailer. It should ►

have friction linings at the sides to prevent excessive wear. Degrease and clean the ball joint before using a stabiliser. The stabiliser can be purchased and installed at a qualified workshop.

### Electronic stabilisation control

The ESC - in particular in conjunction with the trailer stabilisation system ⇒ *page 97* - makes it easier to stabilise a trailer if it starts to skid or sway. You should therefore keep the ESC switched on at all times.

### Overheating

In hot weather, keep an eye on the coolant temperature gauge ⇒ *page 13*. When climbing long hills with the engine running fast in low gear, the coolant temperature can increase. Reduce speed immediately if the needle moves to the right end of the scale. For information on the warning lamp  refer to ⇒ *page 30*.

### Rear carrier systems

*When using rear carrier systems (e.g. bicycle racks) on the towing bracket, it is important not to exceed the maximum load.*

The total weight of the rear carrier system and its load must not exceed 75 kg for this vehicle. However, it is also important to observe the maximum permissible load for the rear carrier system.

The greater the distance from the towing bracket, the smaller the maximum permissible load on the rear carrier system. For this reason, you should secure heavy objects as near as possible to the towing bracket.

Note the instructions provided by the manufacturer of the rear carrier system.

Please make sure that the rear carrier system is approved for use on your vehicle.

#### WARNING

The use of an unsuitable rear carrier system could cause severe damage to the towing bracket. The towing bracket could then break and cause an accident.

#### Note

Degrease and clean the ball joint before using a rear carrier system.

## Removable towing bracket

### Introduction

Applies to: vehicles with removable towing bracket

*Special care is required when fitting and removing the towing bracket.*



**Fig. 84** Luggage compartment: Ball joint for towing bracket (stowage example)

The removable ball joint attachment for the towing bracket is stored under the floor panel or in a separate bag on the floor of the luggage compartment.

The ball joint can be fitted and removed by hand.

#### WARNING

Never use tools of any kind when fitting and removing the ball joint. This could damage the mechanism which locks the ball joint in place and impair its safety – risk of accident!

#### Note

- Do not attempt to modify or repair the ball joint or other towing bracket components.
- Should you have any difficulties when using the towing bracket, or suspect that it is not fitted properly, contact a qualified workshop.
- Before setting off, always check that the ball joint is secured properly ⇒ *page 101*.

## Towing a trailer

- Never disengage the ball joint with the caravan / trailer still hitched or with a bicycle rack or similar accessory still attached.
- It is advisable to remove the ball joint when you are not towing a trailer. Check whether the plug is properly inserted in the mounting fixture and that the bumper cover is fitted.
- The ball joint must be removed if you intend to clean the car with a steam cleaning attachment. Check whether the plug is properly inserted in the mounting fixture and that the bumper cover is fitted.
- For installation and removal of the ball joint we recommend using the gloves provided for this purpose.

### Fitting the ball joint (step 1)

Applies to: vehicles with removable towing bracket



Fig. 85 Area below rear bumper: Pulling out plug



Fig. 86 Removable towing bracket: Ball joint

### Mounting fixture

The mounting fixture for the ball joint is located on the underside of the bumper ⇒ Fig. 85.

- ▶ Remove the plug ⇒ Fig. 85 from the mounting fixture.

- ▶ Check that the mounting fixture is free of dirt; clean if necessary ⇒ ⚠.

### The spring mechanism inside the ball joint must be in the "ready" position.

- ▶ Check that the red marking (2) ⇒ Fig. 86 on the knob is inside the green zone on the ball joint.
- ▶ Check that the locking ball (1) is inside the hole in the shaft section of the ball joint.
- ▶ Check that the knob protrudes visibly from the ball joint, so that there is a clear gap (3) between the knob and the ball joint.

The ball joint can only be installed if the internal spring mechanism is in the ready position.

Continued ⇒ page 100, Fitting the ball joint (step 2).

### ⚠ WARNING

It is important to keep the mounting fixture clean. Otherwise the ball joint may fail to engage securely (accident risk).

### Fitting the ball joint (step 2)

Applies to: vehicles with removable towing bracket

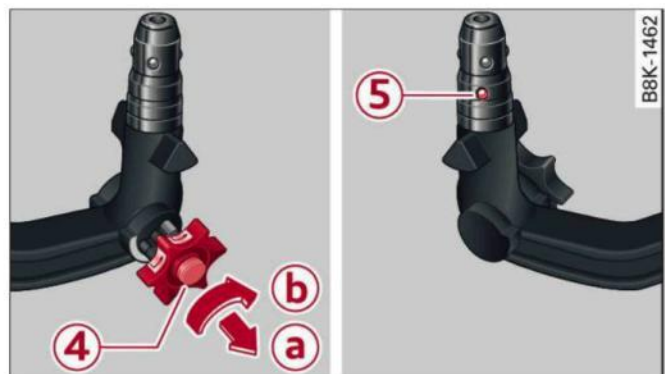

Fig. 87 Removable towing bracket: Setting the spring mechanism to the "ready" position



Fig. 88 Removable towing bracket: Inserting the ball joint

### Setting the spring mechanism to the "ready" position (if required)

- ▶ Insert the key ④ ⇒ Fig. 87 for locking the ball joint into the lock on the knob and turn it clockwise.
- ▶ Pull out the knob in direction ①, hold and turn in direction ② until the locking ball ⑤ engages ⇒ ⚠.

### Inserting the ball joint

- ▶ With the spring mechanism in the "ready" position, insert the ball joint into the mounting fixture and push it upwards ⇒ Fig. 88 in the direction indicated (arrow) ⇒ ⚠. The spring mechanism should then engage automatically with an audible click.
- ▶ Lock the ball joint by turning the key anti-clockwise.
- ▶ Take out the key and press the cover cap onto the lock.

Continued ⇒ page 101, *Fitting the ball joint (step 3)*.

#### ⚠ WARNING

- If it is not possible to set the spring mechanism to the "ready" position as described above, please contact a qualified workshop and, for safety reasons, do not use the ball joint.
- To avoid injury, keep your hands away from the knob when inserting the ball joint in the mounting fixture.

#### **i** Note

Make sure that the knob can turn freely when the ball joint is inserted.

### Fitting the ball joint (step 3)

Applies to: vehicles with removable towing bracket

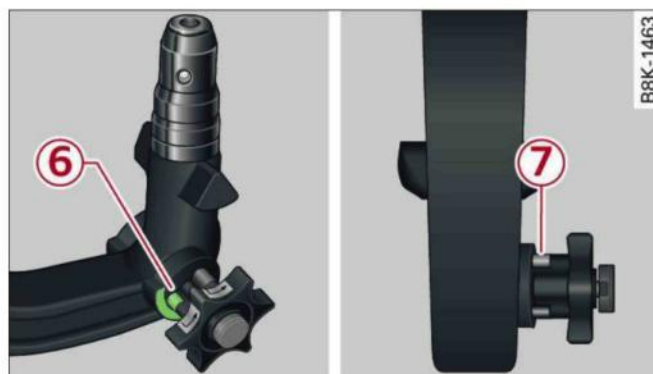

Fig. 89 Removable towing bracket: Safety check

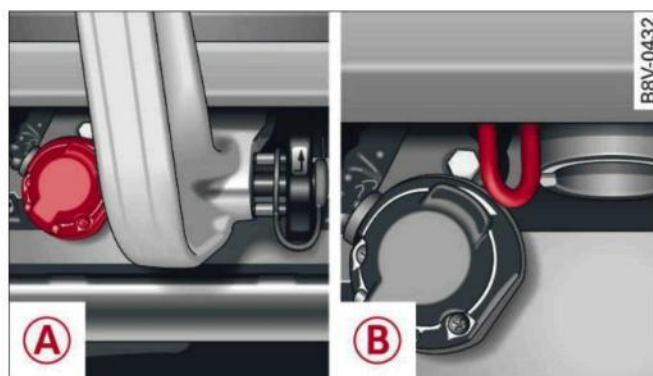

Fig. 90 Area below rear bumper: Connecting socket ①, eye for safety cable ②

- ▶ Check that the green marking ⑥ ⇒ Fig. 89 on the knob is inside the green zone on the ball joint.
- ▶ Check that the knob is directly against the ball joint, so that there is no gap ⑦ between the knob and the ball joint.
- ▶ Check that the ball joint is locked and the key is removed (so that the knob cannot be pulled out).
- ▶ Check that the ball joint fits tightly in the mounting fixture (try moving it about to check).
- ▶ To plug in the electrical connection for the trailer, swivel the connecting socket down from underneath the bumper ① ⇒ Fig. 90.
- ▶ When you hitch a trailer up to your vehicle, hook the safety cable into the eye on the towing bracket ② ⇒ Fig. 90.

#### ⚠ WARNING

To avoid accidents, the towing bracket must not be used if any one of the requirements listed above is not met. If this is the case, the

ball joint must be fitted again properly  
 ⇒ *page 100*. Please contact a qualified workshop in the event of a technical fault.

### **i** Note

The eye **B** on the towing bracket is intended only for securing the safety cable of the trailer.

## Removing the ball joint

Applies to: vehicles with removable towing bracket

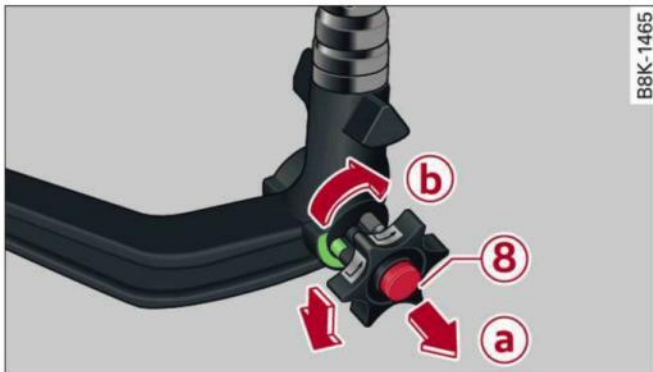

B8K-1465

**Fig. 91** Removable towing bracket: Removing the ball joint



B8V-0107

**Fig. 92** Area below rear bumper: Fitting the plug

- ▶ Take off the cover cap and insert the key **8**  
 ⇒ *Fig. 91* in the lock on the knob.
- ▶ Unlock the ball joint by turning the key clockwise.
- ▶ Take hold of the ball joint and pull out the knob in direction **a**.
- ▶ Keep hold of the knob and turn it as far as it will go in direction **b**.
- ▶ Release the knob. The spring mechanism will remain in the "ready" position ⇒ **!**.
- ▶ Pull the ball joint down out of the mounting fixture.
- ▶ Insert the plug into the mounting fixture  
 ⇒ *Fig. 92*.

- ▶ Swivel the electrical socket upwards as far as the stop.
- ▶ Stow the ball joint underneath the floor panel or in the bag on the floor of the luggage compartment, depending on your vehicle configuration.

### **!** WARNING

- Make sure that the plug is properly fitted in the mounting fixture for the towing bracket. Otherwise the ball joint may fail to engage securely the next time it is attached if dirt has accumulated in the mounting fixture.
- On vehicles in which the ball joint is stowed in a bag on the floor of the luggage compartment, the bag must always be secured to the front right fastening ring. Otherwise the bag could be catapulted through the interior of the vehicle in the event of sudden braking or an accident - risk of injury and accident!

## Retrofitting

Please contact a qualified workshop to find out whether your vehicle can be retrofitted with a towing bracket.

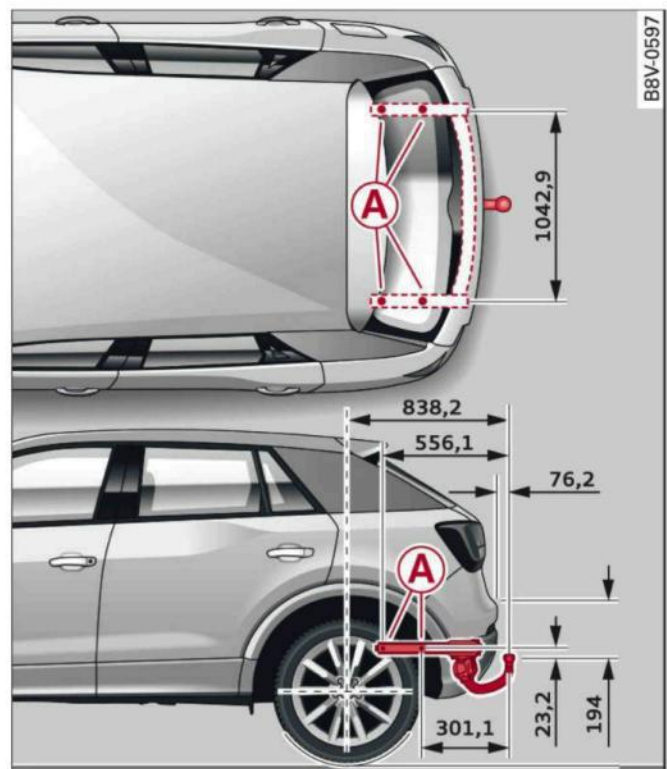

B8V-0597

**Fig. 93** Installation dimensions and positions of securing points



If a towing bracket is to be fitted after the car is purchased, this must be done according to the instructions of the towing bracket manufacturer. The towing bracket is bolted to the body at the securing points  ⇒ Fig. 93.

Qualified workshops are familiar with the method of installation and any modifications which may be required for the cooling system.

 **WARNING**

If a towing bracket is retrofitted, the installation should be carried out by a qualified workshop.

- A towing bracket that is not fitted properly constitutes an accident risk.
- For your own safety, please observe the instructions provided by the manufacturer of the towing bracket.

 **CAUTION**



- If the connector socket is not fitted correctly, this could cause damage to the vehicle's electrical system.
- In particular in high outside temperatures it is not possible to drive up long steep gradients without a suitable cooling system. there is a risk of damaging the engine.

## Driver assist systems

### Speed warning function

Applies to: vehicles with speed warning function

The speed warning function can help you keep below a pre-set maximum speed. It can be set, changed and deleted on the infotainment system.

The speed warning function will warn you if the vehicle exceeds the pre-set maximum speed. The system gives an audible warning signal if the set speed is exceeded by a small amount. At the same time, a warning lamp  and a message will appear on the instrument cluster display. The indicator lamp  and the message will disappear when the road speed drops below the set value.

You are recommended to store this speed limit warning if you wish to be reminded of a particular speed limit. This could be when driving in countries with general speed limits, or if you need to keep below a particular speed when winter tyres are fitted, etc.

#### Setting speed limit warning

- ▶ Select the following on the infotainment system: **MENU** button > **Car** > left control button > **Driver assist** > **Speed warning** > **manual**.

#### Note

- Please bear in mind that, even with the speed warning function, it is still important to keep a check on the car's speed with the speedometer and to observe the statutory speed limits.
- On vehicles for some markets, the speed warning function warns you when you reach a speed of 120 km/h. This speed limit warning is preset at the factory.

## Cruise control system

### Switching on

Applies to: vehicles with cruise control system

The cruise control system allows you to drive at a constant speed of 20 km/h or higher.



Fig. 94 Control lever for cruise control system

- ▶ Pull the lever to position **1** ⇒ Fig. 94 to switch on the system.
- ▶ Drive at the speed you wish to set the system to.
- ▶ Press the button marked **A** to store the speed.

The indicator lamp  in the instrument cluster will light up. Information is also provided in the head-up display\*.

The instrument cluster display will briefly indicate the stored or pre-selected speed.

A constant speed is maintained by adjusting the engine power or braking the vehicle accordingly.

#### WARNING

- Always direct your full attention to the road, even when you are using the cruise control system. It is always the driver who is responsible for determining the speed and for keeping a safe distance to the other vehicles on the road.
- For safety reasons, the cruise control system must not be used in city traffic, stop-and-go traffic, on roads with a lot of bends or in difficult or slippery driving conditions (such as ice, fog, loose grit or gravel, heavy rain, etc.) - risk of accident!
- When you take a turn-off, drive along a motorway exit lane or pass through roadwork

sections, please temporarily switch off the cruise control system.

- Make sure you do not unintentionally rest your foot on the accelerator - this will override the cruise control system which, as a result, will not brake the vehicle.
- The automatic braking function may be deactivated if a system fault occurs in the brake system (e.g. if the brakes overheat) while the cruise control system is activated. All the other cruise control functions remain activated as long as the indicator lamp  is lit.

### CAUTION





Before driving down a long, steep gradient, it is advisable to reduce speed and select a lower gear. In this way you will make use of the engine braking effect and relieve the load on the brakes.

### Note

- Applies to vehicles with manual gearbox: The set speed cannot be reached if the currently selected gear is too high or too low or if the engine would overrev or fail to run smoothly at the target speed. Make sure to change up or down a gear in good time.
- The brake lights come on when the system brakes the vehicle.

### Setting a new speed

Applies to: vehicles with cruise control system

- ▶ **Briefly push** the lever towards / ⇒ *page 104, Fig. 94* to increase or reduce the cruising speed in small steps.
- ▶ To increase or reduce the speed quickly, **hold** the lever towards / until you reach the desired cruising speed.

### Overriding the set speed

Applies to: vehicles with cruise control system

You can use the accelerator pedal to increase speed in the normal way, for example to overtake another vehicle. Once you release the accelera-



tor, the system will revert to the speed you stored initially.

However, if the vehicle exceeds the programmed speed significantly for a long time, the cruise control system will be deactivated temporarily. The indicator lamp  in the instrument cluster will go out, but the programmed speed will remain stored.

### Pre-selecting a speed

Applies to: vehicles with cruise control system

*You can pre-select a desired speed while the vehicle is stationary.*

- ▶ Switch on the ignition.
- ▶ Pull the lever to position  ⇒ *page 104, Fig. 94.*
- ▶ Press the lever up towards  or down towards  in order to increase or reduce the cruising speed setting.

This function allows you to enter the desired cruise control setting speed ahead of time, for example before joining a motorway. Once you are on the motorway, you can activate the cruise control system by pulling the lever to position .

### Switching off

Applies to: vehicles with cruise control system

#### Switching off temporarily

- ▶ Press the brake pedal, or
- ▶ Push the lever to position  (click stop not engaged) ⇒ *page 104, Fig. 94, or*

#### Switching off completely

- ▶ Push the lever to position  (click stop engaged), or
- ▶ Switch off the ignition.

The speed setting will remain stored after the system is temporarily deactivated. To resume the programmed cruising speed, release the brake pedal and pull the lever to position .

The stored speed will be deleted once the ignition is switched off. ▶

### Automatic deactivation

 **Cruise control system: currently unavailable.**  
See owner's manual

The cruise control system has been automatically deactivated because the system has detected a fault which could impair its function. Try switching the cruise control system on again later.

 **WARNING**

Do not resume the programmed cruising speed if this is too high for the traffic conditions - this can cause accidents.

## Speed limiter

### Description

Applies to: vehicles with speed limiter

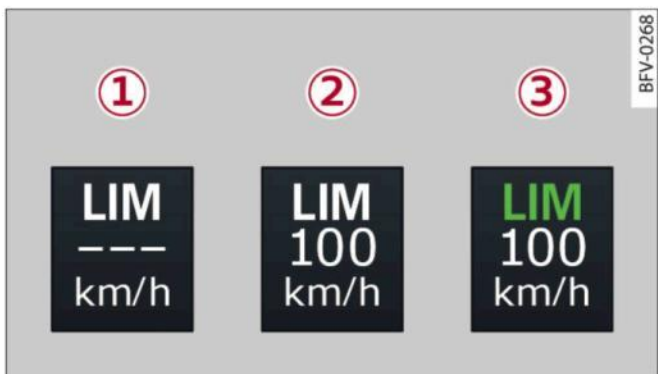

Fig. 95 Speed limiter: illustration

At speeds above approximately 30 km/h, the speed limiter helps prevent the driver from exceeding a set cut-off speed. The indicator lamp **LIM** lights up as soon as you switch on the speed limiter. Information is also provided in the head-up display\*.

### Speed limiter displays

- ① - The speed limiter is in passive mode, but a cut-off speed has not yet been set.
- ② - The speed limiter is in passive mode, and a set cut-off speed has been stored.
- ③ - The speed limiter is activated. The indicator lamp **LIM** flashes briefly when the speed limiter is applied.

1) On some equipment versions, the speed limiter is not available and button **B** has no function.

### WARNING

- Always direct your full attention to the road, even when you are using the speed limiter. It is always the driver who is responsible for determining the speed and for keeping a safe distance to the other vehicles on the road.
- For safety reasons, the speed limiter must not be used in adverse weather or difficult driving conditions (such as ice, fog, loose grit or gravel, heavy rain, etc.) - risk of accident!
- Only accelerate quickly or use the kick-down feature when the visibility and weather conditions are suitable, and when the road and traffic conditions allow you to do so safely.

### CAUTION

Before driving down a long, steep gradient, it is advisable to reduce speed and select a lower gear. In this way you will make use of the engine braking effect and relieve the load on the brakes.

### Switching on

Applies to: vehicles with speed limiter



Fig. 96 Control lever for cruise control system (example)

- ▶ Pull the lever to position ① to switch the system on.
- ▶ Applies to vehicles with cruise control system or Audi adaptive cruise control: To switch to the speed limiter, press the button **B**<sup>1)</sup> until the driver message **LIM Speed limiter: selected** appears in the instrument cluster.

- ▶ Press button **(A)** to store the cut-off speed while the car is moving.

The instrument cluster display will indicate the stored cut-off speed, and the indicator lamp **LIM** will light up.

Applies to: vehicles with cruise control system or Audi adaptive cruise control

While the speed limiter is switched on, you can switch to the cruise control ⇒ *page 104* or adaptive cruise control ⇒ *page 111* systems. Press button **(B)**<sup>1)</sup> until the corresponding system is displayed in the instrument cluster.

The last cut-off speed set for the speed limiter remains stored and can be applied again when you switch back into speed limiter mode.

### Changing the cut-off speed

Applies to: vehicles with speed limiter

- ▶ **Briefly push** the lever towards **(+/-)** ⇒ *page 106, Fig. 96* to increase or reduce the cut-off speed in small steps.
- ▶ To increase or reduce the cut-off speed in bigger steps, **hold** the lever towards **(+/-)** until you reach the desired cruising speed.

### Overriding the cut-off speed

Applies to: vehicles with speed limiter

To override the speed limiter temporarily, press the accelerator fully past the point of resistance (kick-down feature).

Speed limiting is suspended temporarily. The indicator lamp **LIM** flashes while the system is deactivated; the cut-off speed setting will remain stored. The system is reactivated automatically as soon as your speed drops below the original stored setting.

### Switching off

Applies to: vehicles with speed limiter

#### Switching off temporarily

- ▶ Push the lever towards **(2)** (click stop not engaged) ⇒ *page 106, Fig. 96*. The instrument cluster display will indicate the stored cut-off speed, and the indicator lamp **LIM** will light up.

#### Switching off completely

- ▶ Push the lever to position **(2)** (click stop engaged), or
- ▶ Switch off the ignition.

The cut-off speed setting will remain stored after the system is temporarily deactivated. To resume the programmed cut-off speed, pull the lever to position **(1)**. The vehicle speed is limited to the stored cut-off setting as soon as your current driving speed drops below the stored cut-off speed.

The stored cut-off speed will be deleted once the ignition is switched off.

#### Automatic deactivation

**LIM** Speed limiter: currently unavailable. See owner's manual

The speed limiter has been automatically deactivated because the system has detected a fault which could impair its function. Try switching on the speed limiter again later.

#### WARNING

The speed limiter may be deactivated if a fault occurs in the brake system (e.g. if the brakes overheat) while the speed limiter is activated.

#### Note

If a system fault requires the speed limiter to switch off automatically, for safety reasons it does not switch off completely until the driver releases the accelerator pedal once or deactivates the system manually.

<sup>1)</sup> On some equipment versions, the speed limiter is not available and button **(B)** has no function.

## Camera-based traffic sign recognition

### Description

Applies to: vehicles with camera-based traffic sign recognition



Fig. 97 Instrument cluster: Traffic sign recognition

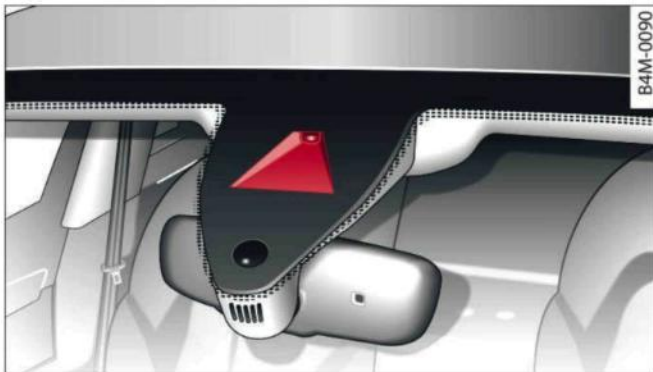

Fig. 98 Windscreen: Camera window for traffic sign recognition

Traffic signs detected by the system appear in the instrument cluster display to keep you informed of current speed restrictions and no-overtaking zones ⇒ Fig. 97. Within certain system limits, it will display these additional traffic restrictions:

|  |   |
|--|---|
|  | Speed limits in wet weather   |
|  | Speed limits in foggy conditions (only displayed when the all-weather lights or rear fog light are switched on) |
|  | Speed limits at certain times of day  |
|  | Speed limits when towing a trailer  |

### General notes

The traffic sign recognition system can detect standardised speed limit signs within the camera's range of vision. It makes use of the navigation data to evaluate the detected speed limits and show them on the display. Under certain con-

ditions, the system will also display the legal speed limits on roads without speed limit signs. The traffic sign for the currently detected speed limit will flash on the display if a speed warning threshold, which has been set on the infotainment system, is exceeded ⇒ page 109.

Traffic sign recognition is not available in all countries. For a current list, see the Internet (e.g. [www.audi.com](http://www.audi.com)). The system is also subject to certain inherent restrictions and may be partially or completely unavailable in the following situations:

- If visibility is impaired by snow, rain, fog or heavy road spray.
- In dazzling light, e.g. from the sun or oncoming traffic.
- At high speeds.
- If the camera's range of vision ⇒ Fig. 98 is impaired, e.g. by dirt or stickers. Notes on cleaning ⇒ page 312.
- If the traffic signs are partially or completely obscured, e.g. by trees, snow, mud or other vehicles.
- If traffic signs deviate from the standard appearance (round with red border).
- If traffic signs are damaged or bent.
- If matrix traffic signs are mounted on overhead gantries.
- If traffic signs or routes have changed (navigation data out of date).
- If the system detects a speed sticker on a slow-moving vehicle (such as a heavy goods vehicle).

### WARNING

Always direct your full attention to the road and surroundings, even when you are using traffic sign recognition. The actual traffic signs on your route always take precedence over the information on the display. It is always the driver's responsibility to assess the traffic situation and take appropriate care.

- Under adverse conditions, the traffic sign recognition system may misinterpret or fail to detect traffic signs. It is therefore possible that the speed limit display may occasionally be unavailable or even incorrect.

- The traffic sign detection system does not adjust the speed of your vehicle to the speed limits.

### **i** Note

The speed limit displayed in the instrument cluster is given in the units applicable in a particular country.

## Controls

Applies to: vehicles with camera-based traffic sign recognition



Fig. 99 Instrument cluster: Secondary display

### Calling up the traffic sign recognition

- ▶ Call up the first tab (on-board computer) using the **<>** button on the multi-function steering wheel.
- ▶ Applies to vehicles with analogue instrument cluster: Press the **☰** button and select **Traffic signs** from the menu.
- ▶ Applies to vehicles with Audi virtual cockpit: Select the display for **Traffic signs**.

### Displaying signs for trailers

You can also display speed limits which apply specifically to vehicles towing a trailer<sup>1)</sup>.

- ▶ Select the following on the infotainment system: **MENU** button > **Car** > left control button **Driver assist** > **Traffic signs** > **Automatic trailer recognition**.

### Setting the maximum speed for a trailer

You can set the maximum speed permitted for your type of trailer<sup>1)</sup>. If you do not enter a value,

the system will show the maximum national speed limit for vehicles towing a trailer.

- ▶ Select the following on the infotainment system: **MENU** button **Car** > left control button **Driver assist** > **Traffic signs** > **Trailer: highest speed**.

### Setting speed warning

You can set a warning threshold up to 15 km/h. The traffic sign for the currently detected speed limit will flash on the display if the selected warning threshold is exceeded.

- ▶ Select the following on the infotainment system: **MENU** button > **Car** > left control button > **Driver assist** > **Speed warning** > **Traffic sign based**.

### Secondary display

If the instrument cluster is currently showing a function other than traffic sign recognition, the speed limit will be displayed in the top right-hand corner ⇨ Fig. 99. If the system is able to detect a temporary speed restriction in a given situation, it will update the display accordingly.

Temporary speed restrictions are displayed in the following situations:

- A temporary speed restriction for wet weather is detected while the windscreen wipers are operating.
- A speed restriction for fog is detected while the vehicle's rear fog light or all-weather lights are switched on.
- A speed restriction applying at certain times of day has been detected and corresponds to the time displayed in the instrument cluster.
- The vehicle is towing a trailer and the **Automatic trailer recognition** option is activated on the infotainment system. In this case, restrictions applying to trailers are displayed<sup>1)</sup>.

### **i** Note

- Your speed warning settings and the maximum trailer speed will be automatically stored and assigned to the remote control

<sup>1)</sup> Applies to factory-fitted towing brackets only

key in use. If you change to a different type of trailer, you may need to change the maximum trailer speed setting.

- Information is also provided in the head-up display\*.
- Please note that the navigation system (SD card)\* is immediately no longer available if the SD card is removed from the SD card reader.

### Driver messages

Applies to: vehicles with camera-based traffic sign recognition

#### **Traffic sign recognition: currently unavailable. No camera view**

This message will appear if the camera view is obstructed ⇒ *page 108*. The system will switch itself off.

#### **Traffic sign recognition: currently restricted**

This message appears, for instance, in the event of a navigation system fault. The limited functionality may cause fewer speed limits to be displayed (which increases the possibility of an error).

#### **Traffic sign based speed warning: currently unavailable. See owner's manual**

No warning will be given if the selected warning threshold is exceeded.

#### **Traffic sign recognition: system fault**

The function of the system is impaired; the system will be deactivated. Drive to a qualified workshop soon.

#### **No traffic sign recognised**

No relevant navigation data are available, and no speed limit has been detected.

#### **Traffic sign recognition: outside operational area**

#### **Function unavailable in this country**

The vehicle is being driven in a country outside the system's operational area.

## Rest recommendation

### General notes

Applies to: vehicles with rest recommendation

*Under certain conditions, the system can detect that the driver needs to take a break.*

At the beginning of a trip, the system monitors the driver's general steering style. Using this as a reference, the system continuously compares the current steering input at speeds of between 60 km/h and 200 km/h. If the evaluation of the steering input implies a lapse in the driver's concentration, the system will then recommend a break ⇒ *page 111, Instrument cluster display*.

The rest recommendation function is designed for journeys on motorways and major roads.

### System limitations

The rest recommendation function may misinterpret the steering input in certain driving situations, such as the following:

- On twisty roads.
- On rough roads.
- In poor weather.
- During performance driving.
- When the driver's attention is distracted.

### Resetting the system

The system is automatically reset if you...

- switch off the ignition.
- release the driver's seat belt and open the driver's door.
- drive slower than 60 km/h for a while. If you subsequently increase your speed again, the system will reevaluate the driving style.

### **WARNING**

- Never drive when you are tired. As a driver you are always responsible for ensuring that you are fit to drive.
- On long journeys, make sure to take adequate breaks at regular intervals.
- The system cannot always tell if you need a break.



- In certain situations, the system may misinterpret driving manoeuvres and inappropriately recommend a break.
- No acute warning is given if the driver falls into a microsleep.

### Instrument cluster display

Applies to: vehicles with rest recommendation

#### Rest recommended

If the warning lamp lights up and the message appears, the evaluation of the steering input has resulted in a rest recommendation. This is also indicated by a warning tone. Take a break as soon as possible.

The message may be displayed again once if necessary.

### Switching on/off

Applies to: vehicles with rest recommendation

Select the following on the infotainment system:

**MENU** button > **Car** > left control button > **Driver assist** > **Rest recommendation**.

#### Note

If you switch off the system, it will remain switched off the next time you switch on the ignition.

## Audi adaptive cruise control

### Description

Applies to: vehicles with Audi adaptive cruise control

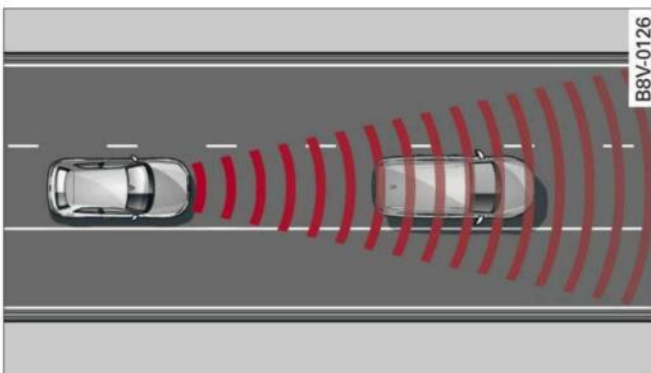

Fig. 100 Sensor range

The adaptive cruise control is a combined speed and distance control system. It assists the driver by controlling the road speed and the distance to the vehicle in front within certain limits imposed by the system. The adaptive cruise control system can accelerate and brake when it detects a vehicle in front. This provides maximum comfort both on long motorway journeys and in congested traffic (automatic gearbox\*).

### What can the adaptive cruise control do?

The adaptive cruise control uses a radar. The radar is subject to certain system limitations ⇒ *page 112*.

When there is no traffic in front, the adaptive cruise control works just like a normal cruise control system by maintaining a constant speed. When you draw closer to a vehicle in front which is detected by the system, the adaptive cruise control matches your speed to that vehicle by automatically applying the brakes, and then maintains a constant distance (which you can adjust in the settings). As soon as it detects no more vehicles in front, the adaptive cruise control accelerates back up to the cruising speed.

Applies to: vehicles with automatic gearbox

In congested traffic, the adaptive cruise control can brake down to a standstill and accelerate again (subject to general system limitations) under certain conditions ⇒ *page 115, Driving in congested traffic*. The traffic jam assist (active lane assist)\* can assist the driver in traffic jams and heavy congestion ⇒ *page 117*.

### Which functions can the driver control?

When you switch on the adaptive cruise control, you can set your current speed as the “cruising speed” ⇒ *page 113, Switching on/off*.

While you are driving, you can interrupt the cruise control ⇒ *page 115* or change the speed setting ⇒ *page 114* at any time.

In addition, you can adjust the distance to vehicles in front and the driving program for the adaptive cruise control ⇒ *page 116*.

### General notes

Applies to: vehicles with Audi adaptive cruise control/Audi pre sense front



Fig. 101 Front of vehicle: Sensor

The area surrounding the radar sensor ⇒ Fig. 101 must be kept free of stickers, deposits and any other substances which could impair the function of the adaptive cruise control and pre sense front systems. Notes on cleaning ⇒ page 312. Please bear the above in mind if technical modifications are made to the front of the vehicle.

The functionality of the adaptive cruise control or pre sense front systems is restricted in certain situations:

- Vehicles cannot be detected until they are within the range of the sensor ⇒ page 111, Fig. 100.
- The ability of the system to detect vehicles in front is limited when they are too close, travelling out of line, or moving into your lane.
- Vehicles that are not clearly discernible, e.g. a motorcycle or cyclist travelling in front of you and vehicles with high ground clearance or a protruding load, are often identified late or are not detected at all.
- When driving through bends ⇒ page 112.
- When vehicles are stationary ⇒ page 113.

### ⚠ WARNING

Please always direct your full attention to the road, even when you are using adaptive cruise control. It is always the driver who is responsible for pulling away safely and maintaining a safe speed and distance from other vehicles. The purpose of the adaptive cruise control is to assist the driver. The driver must always intervene manually to avoid an impending collision.

sion. As the driver you are always responsible for braking in good time.

- For safety reasons, the adaptive cruise control must not be used on roads with a lot of bends or in poor weather or difficult or slippery driving conditions (such as ice, fog, loose grit or gravel, heavy rain, etc.) - risk of accident!
- When you take a turn-off, drive along a motorway exit lane or pass through roadwork sections, please temporarily switch off the adaptive cruise control system. This is to ensure that the vehicle does not accelerate to the cruising speed in such situations.
- The adaptive cruise control system will not brake the vehicle automatically if you rest your foot on the accelerator pedal. Resting your foot on the accelerator pedal overrides the speed and distance control function.
- The adaptive cruise control does not react to pedestrians, animals or crossing or oncoming traffic.
- Reflecting objects, such as crash barriers, the entrance to a tunnel, heavy rain or ice can impair the function of the radar sensor.

### ⚠ CAUTION

Impacts or damage to the bumper, wheel arches or underbody can cause misalignment of the sensor. This can impair the effectiveness of the adaptive cruise control. Have the systems checked by a qualified workshop.

### When driving through a corner

Applies to: vehicles with Audi adaptive cruise control/Audi pre sense front

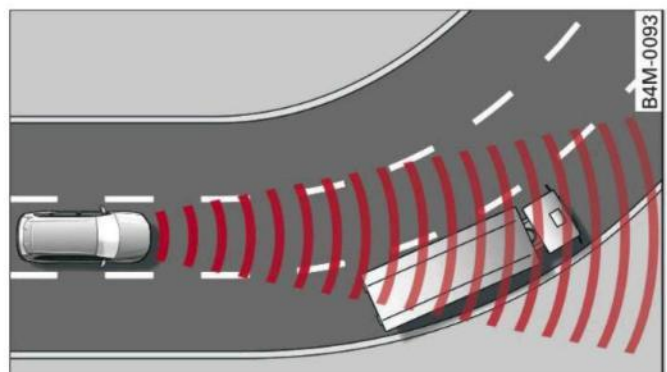

Fig. 102 Example: Driving into a bend

When driving into a bend ⇒ Fig. 102 and driving out of a bend, the system may react to a vehicle travelling in the next lane and therefore brake the vehicle. You can prevent this from happening by accelerating briefly.

### Stationary vehicles

Applies to: vehicles with Audi adaptive cruise control

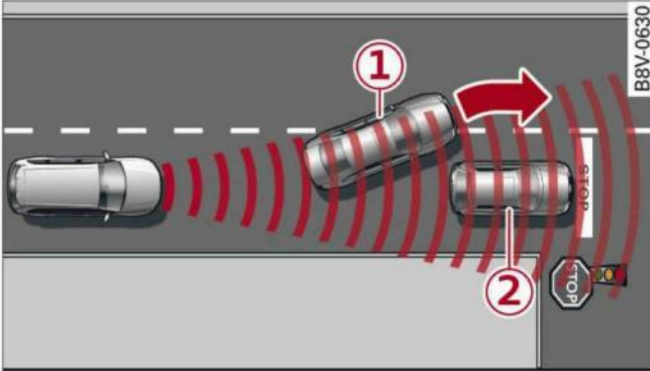

Fig. 103 Example: Vehicle changing lane and vehicle stationary

### Adaptive cruise control

The adaptive cruise control system only reacts to vehicles which are moving or which have already been detected as moving vehicles. For example, if a vehicle ①, which has already been detected by the adaptive cruise control, turns off or changes lane and another stationary vehicle ② is located in front of that vehicle, the system will not react to the stationary vehicle. Press the brake pedal to slow down.

### Vehicles with manual gearbox

Applies to: vehicles with Audi adaptive cruise control and manual gearbox

The adaptive cruise control is available in second gear or higher (when driven in the normal engine speed range).

When the adaptive cruise control is switched on, you must press the clutch pedal in the normal way in order to change gear. The adaptive cruise control will remain activated when you change gear or press the clutch pedal.

You do **not** need to press the accelerator after selecting a gear and releasing the clutch. The adap-

tive cruise control system accelerates the vehicle automatically as appropriate.

The adaptive cruise control may be switched off automatically if you keep the clutch pedal depressed for too long or if you change gears incorrectly or use the clutch pedal improperly.

### Switching on/off

Applies to: vehicles with Audi adaptive cruise control



Fig. 104 Control lever: Switching on/off



Fig. 105 Instrument cluster display: Adaptive cruise control

**ACC:** You can set any speed<sup>1)</sup> between 30 and 200 km/h.

Indicator lamps and messages in the instrument cluster display will provide you with information about the current driving situation and settings.



Information is also provided in the head-up display\*.

### Switching on the adaptive cruise control

- Pull the lever towards you to position ① ⇒ Fig. 104.

1) The speed range may be different in some countries.

### Setting the speed and activating the cruise control

- ▶ To set the current speed as the cruising speed and activate the cruise control, press the **SET** button ⇒ Fig. 104 ⇒ . The speed setting is indicated by the LEDs  in the speedometer and is also shown briefly in the system status indicator  ⇒ Fig. 105.
- ▶ Vehicles with automatic gearbox: To activate the cruise control when the vehicle is stationary, the hold assist\* function must have been activated or you must press the brake pedal.

### Switching off the adaptive cruise control

- ▶ Push the lever away from you to position  until it engages. The message **ACC: off** will appear.

The LEDs indicating the stored speed in the speedometer dial will go out.

### Warning and indicator lamps

 - The adaptive cruise control is switched on. No vehicle has been detected in front. A constant cruising speed is being maintained.

 - A vehicle in front has been detected. The adaptive cruise control is regulating the speed to maintain a constant distance to the vehicle in front, and will accelerate and brake the vehicle automatically.

 - Automatic gearbox: The adaptive cruise control is switched on. A vehicle in front has been detected. Your vehicle is stationary and will not be set in motion again automatically.

 - The adaptive cruise control alone is not able to brake the vehicle sufficiently to maintain a safe distance to the vehicle in front. You must intervene ⇒ page 117, *Driver intervention prompt*.

### Graphical display in instrument cluster

If the adaptive cruise control is not shown on the instrument cluster display, you can call up the display using the controls on the multi-function steering wheel ⇒ page 15.

The graphical display shows you when a vehicle in front is detected and indicates how far away you are from that vehicle:

**No vehicle** - No vehicle has been detected in front.

**Vehicle in silver** - A vehicle has been detected in front.

**Vehicle in red** - Driver intervention prompt ⇒ page 117.

The five **distance bars** on the **scale**  represent the distance setting (for information on how to change the distance setting, refer to ⇒ page 116). The distance bars are coloured in red from the bottom up if the actual distance is shorter than the distance selected.

### WARNING

Applies to: vehicles with automatic gearbox

If you press the **SET** button at a speed of less than 30 km/h, the vehicle will automatically accelerate up to the minimum speed setting of 30 km/h.

### Note



- The speed setting is cleared for safety reasons when you switch off the ignition or the adaptive cruise control system.
- Applies to vehicles with front-wheel drive: The electronic stabilisation control (ESC) and traction control system (ASR) are automatically activated when the adaptive cruise control is switched on.

### Setting a new speed

Applies to: vehicles with Audi adaptive cruise control





Fig. 106 Control lever: Setting a new speed

- ▶ **Briefly push** the lever towards / to increase or reduce the cruising speed in small steps.

- ▶ To increase or reduce the speed quickly, **hold** the lever towards  $\oplus/\ominus$  until the LED  $\textcircled{2}$  ⇒ page 113, Fig. 105 reaches the desired cruising speed.

You can preselect the speed, even when the adaptive cruise control is inactive, by moving the lever in the appropriate direction  $\oplus/\ominus$ . To activate the preselected speed, pull the lever to position  $\textcircled{1}$  ⇒ page 113, Fig. 104.

Following any changes, the new stored speed will be displayed briefly in the status line ⇒ page 113, Fig. 105  $\textcircled{5}$ . The indicator lamp  is also lit when the adaptive cruise control is active, and the indicator lamp  is lit when the adaptive cruise control is inactive. The indicator lamp  will light up instead in the Audi virtual cockpit\*.

### Driving in congested traffic

Applies to: vehicles with Audi adaptive cruise control and automatic gearbox

The adaptive cruise control assists you when driving in congested traffic. If a vehicle which has been detected in front stops, the adaptive cruise control applies the brakes (within the limits imposed by the system) and holds the vehicle at a standstill.

- ▶ To set the vehicle in motion again with the adaptive cruise control, tap the accelerator with your foot, or
- ▶ Pull the lever towards you to position  $\textcircled{2}$  ⇒ page 115, Fig. 107.

### Using the adaptive cruise control to set the vehicle in motion<sup>1)</sup>

If the message **ACC: ready to drive off** is on the display and the vehicle in front drives off, your vehicle will automatically start moving ⇒ . You can reactivate the **ACC: ready to drive off** message briefly by pulling the lever to position  $\textcircled{2}$ .

For safety reasons, your vehicle will start moving only if

- the driver's seat belt is buckled,

- all the doors and the bonnet are closed,
- your vehicle has been stationary for less than 3 minutes.

### WARNING

If the **ACC: ready to drive off<sup>1)</sup>** message appears, your vehicle will start moving even if there is an obstacle between your car and the vehicle in front - risk of accident!

### Note

If your vehicle does not start moving as expected with the adaptive cruise control, even though the **ACC: ready to drive off<sup>1)</sup>** message is displayed, you can set the vehicle in motion by tapping the accelerator with your foot.

### Interrupting the cruise control

Applies to: vehicles with Audi adaptive cruise control



Fig. 107 Control lever

Important: The adaptive cruise control must be on.

### Overriding the cruise control

- ▶ To accelerate manually, pull the lever towards you to position  $\textcircled{2}$  and hold it in this position or press the accelerator. The message **ACC: override** will appear.
- ▶ To reactivate the cruise control, release the lever or take your foot off the accelerator.

### Interrupting the cruise control while driving

- ▶ Move the lever to position  $\textcircled{3}$ . The message **ACC: standby** will appear. Or:
- ▶ Apply the brakes.

<sup>1)</sup> Not available on vehicles for some markets.

- ▶ To reactivate the cruise control and accelerate back up to the target speed, move the lever to position ②.

### Interrupting the cruise control while stationary

Applies to: vehicles with automatic gearbox

- ▶ Push the lever away from you to position ③. The message **ACC: standby** will appear.
- ▶ To reactivate the cruise control, press the brake pedal and pull the lever towards you to position ②.

#### **WARNING**

It is dangerous to activate the cruise control and accelerate back up to a target speed which is too high for the current road, traffic or weather conditions - risk of accident!

### Setting the distance

Applies to: vehicles with Audi adaptive cruise control



Fig. 108 Control lever: Setting the distance

- ▶ To display the current distance setting, briefly press the rocker switch ⇒ Fig. 108.
- ▶ To increase or reduce the distance by one level, briefly press the rocker switch up or down again. The distance between the two vehicles will be shown on the instrument cluster display.

When you draw closer to a vehicle in front, the adaptive cruise control matches your speed to that vehicle by applying the brakes, and then maintains a constant distance (which you can adjust in the settings). If the vehicle in front accelerates, the adaptive cruise control will also accelerate up to the target speed you have specified.

The higher the speed, the higher the distance ⇒ . We recommend using the **distance 3** setting. You will then be following the general recommendations of automobile clubs, traffic authorities, etc.

The actual distance maintained by the adaptive cruise control may be longer or shorter, depending on the traffic situation and the driving style of the driver in front.

If you change the gap, the new setting will be shown briefly on the instrument cluster display, e.g.  for **distance 3**. This only happens when the adaptive cruise control display is not visible in the instrument cluster ⇒ page 113, Fig. 105.

**Distance 1:** This setting is equivalent to a distance of approximately 28 metres at a speed of 100 km/h (time-based distance of approximately 1 second).

**Distance 2:** This setting is equivalent to a distance of approximately 36 metres at a speed of 100 km/h (time-based distance of approximately 1.3 seconds).

**Distance 3:** This setting is equivalent to a distance of approximately 50 metres at a speed of 100 km/h (time-based distance of approximately 1.8 seconds).

**Distance 4:** This setting is equivalent to a distance of approximately 67 metres at a speed of 100 km/h (time-based distance of approximately 2.4 seconds).

**Distance 5:** This setting is equivalent to a distance of approximately 100 metres at a speed of 100 km/h (time-based distance of approximately 3.6 seconds).

#### **WARNING**

When setting the distance, the driver is responsible for adhering to the locally applicable laws and regulations.

#### **Note**

Your personal settings are stored automatically and assigned to the remote control key which is being used.

### Setting the driving program

Applies to: vehicles with Audi adaptive cruise control

The acceleration style ranges from dynamic to comfortable, depending on the selected driving program and the distance setting.

### Selecting the driving program on vehicles without drive select\*

- ▶ Select the following on the infotainment system: **MENU** button > **Car** > left control button > **Driver assist** > **Audi adaptive cruise control** > **Driving program** > **comfort, standard or dynamic**.

### Selecting the driving mode on vehicles with drive select\*

Refer to ⇒ *page 132*.

#### **i** Note

Your personal settings are stored automatically and assigned to the remote control key which is being used.

### Driver intervention prompt

Applies to: vehicles with Audi adaptive cruise control



Fig. 109 Instrument cluster: Driver intervention prompt

You are prompted to intervene manually if the adaptive cruise control system alone is not able to brake the vehicle sufficiently to maintain a safe distance to the vehicle in front ⇒ *Fig. 109*.

### Traffic jam assist

Applies to: vehicles with traffic jam assist

The traffic jam assist function helps the driver in traffic jams or congested traffic.



Fig. 110 Turn signal lever: Traffic jam assist activation button



Fig. 111 Instrument cluster: Traffic jam assist

The traffic jam assist is an extension of the active lane assist ⇒ *page 123* and uses its functions in conjunction with the functions of the adaptive cruise control ⇒ *page 111*. The traffic jam assist can help to keep the vehicle in lane. The system steers the vehicle automatically when the adaptive cruise control is switched on (subject to certain inherent system limitations). As the name implies, the purpose of the traffic jam assist function is to assist the driver; the driver must keep his/her hands on the steering wheel at all times and must always be ready to take over the steering. The driver can override the automatic steering at any time by steering manually.

The system is designed for driving on motorways and major roads.

### Requirements for using the traffic jam assist

- ▶ The vehicle's speed must be below 65 km/h.
- ▶ The active lane assist must be switched on and it must have detected a demarcation line on

both sides of the lane you are in ⇒ *page 124*.  
The **early** setting must be selected for the steering input on the infotainment system ⇒ *page 126*.

- ▶ The adaptive cruise control must be switched on and activated ⇒ *page 113*.



### Switching the traffic jam assist on/off

- ▶ Press the button ⇒ *Fig. 110* to switch the system on/off.

### Always switch off the traffic jam assist in the following situations:

- In situations requiring extra care and attention from the driver.
- In poor weather, for instance in snow or heavy rain.
- In poor road conditions.
- In roadwork areas.
- In city traffic.

### Indicator lamps

 and  - Traffic jam assist is switched on. Vehicle detected in front. The system is controlling your vehicle as it moves ⇒ *Fig. 111*.

If the driver does not take over the steering after being prompted with several severity levels, the traffic jam assist will be switched off and the emergency assist will be activated ⇒ *page 126*.

#### **WARNING**

Always leave your hands on the steering wheel and be ready to steer at all times. It is always the driver's responsibility to keep in the traffic lane and to assess the traffic situation and take appropriate care. Please observe the safety warnings ⇒  in *General notes on page 112*. Never use the traffic jam assist in the following situations - risk of accident!

- On off-road terrain or unsealed roads.
- In city traffic or roadwork areas.
- On twisty roads.
- In narrow traffic lanes.
- In unpredictable traffic situations, e.g. at intersections or toll gates.

#### **Note**

The system does not always keep the vehicle in the centre of the lane.

## Distance indicator and distance warning

Applies to: vehicles with Audi adaptive cruise control

*This function measures the distance to the vehicle in front in time units and shows the result on the instrument cluster display.*



**Fig. 112** Instrument cluster: Distance indicator/warning

### Description

This function measures the distance to the vehicle in front in time units at speeds above approximately 65 km/h.

- ▶ Switch to the adaptive cruise control display in the instrument cluster ⇒ *page 15*.

A warning lamp  will appear if the distance is below the threshold.

### Setting speed limit warning

The infotainment system is used to set, alter or cancel the speed limit warning.

- ▶ Select the following on the infotainment system: **MENU** button > **Car** > left control button > **Driver assist** > **Distance warning**.

#### **WARNING**

- Please observe the safety warnings ⇒  in *General notes on page 112*.
- As the driver you are always responsible for adhering to the locally applicable laws and regulations.



**i Note**

The distance may be below the warning threshold for a short time when overtaking or approaching a slower vehicle quickly from behind. In this case, no warning will be given. A warning is only given if the distance is consistently below the threshold.

**Driver messages**

Applies to: vehicles with Audi adaptive cruise control

** ACC: not available**

The system cannot detect vehicles reliably and will be deactivated. The sensor is out of alignment or defective. Drive to a qualified workshop and have the fault rectified.

** ACC: currently unavailable. No sensor vision**** ACC: currently unavailable. Sensor view restricted due to surroundings. See owner's manual**

These messages appear if the radar sensor vision is impaired, e.g. by leaves, snow, heavy road spray or dirt. Clean the sensor ⇒ *page 112, Fig. 101.*

** ACC: currently unavailable. Speed too low**

Manual gearbox: This message appears if the current speed is too low for ACC mode. You cannot store speed settings below 30 km/h. The cruise control system switches off if the speed falls below 20 km/h.

** ACC: available from 2nd gear up**

Manual gearbox: The adaptive cruise control only operates in 2nd gear or higher.

** ACC: currently unavailable. Gradient too steep**

The maximum possible road gradient for safe operation of the adaptive cruise control has been exceeded. The adaptive cruise control cannot be switched on.

** ACC: only available in D, S or M**

Automatic gearbox: Move the selector lever to position D/S or M.

** ACC: clutch pedal pressed**

Automatic gearbox: Cruise control mode is deactivated if the clutch pedal is pressed for a relatively long period.

** ACC: engine speed**

Manual gearbox: This message appears if the driver does not change gear in time when the adaptive cruise control accelerates or brakes the vehicle and the engine speed is too high or low as a result. The adaptive cruise control is switched off.

** ACC: parking brake applied**

The adaptive cruise control system is deactivated if the parking brake is applied. The adaptive cruise control will be available again when the parking brake is released.

** ACC: currently unavailable. Stabilisation control input**

This message appears if the electronic stabilisation control (ESC) intervenes. In this case, the adaptive cruise control will automatically be switched off.

** ACC off: manual control!**

This message appears if the vehicle rolls backwards when driving away on a slight gradient, even though the adaptive cruise control is active. Press the brake pedal to prevent the vehicle from rolling back or colliding with an object behind.

** ACC: currently unavailable. Park assist active**

The systems are switched off when the park assist\* is active. The systems will be available again when the parking manoeuvre is finished.

**Distance warning: fault. Please contact workshop**

The system cannot detect vehicles reliably and will be deactivated. The radar sensor is out of alignment or defective. Drive to a qualified workshop and have the fault rectified.

**Distance warning: currently unavailable. Sensor view restricted due to surroundings** ▶

## Driver assist systems

This message appears if the radar sensor vision is impaired, e.g. by leaves, snow, heavy road spray or dirt. Clean the sensor ⇒ *page 112, Fig. 101.*

### Distance warning: currently unavailable. See owner's manual

This driver message will appear if the system fails temporarily. If the fault occurs repeatedly, drive to a qualified workshop and have the fault rectified.

### Fasten seat belt

The system is not fully available when the driver's seat belt is unfastened.

### Stationary object ahead

This message appears if you try to switch on the system when a stationary object is located immediately in front of your car.

### Door open

The system is not available when the vehicle is stationary and the driver's door is open.

## Audi pre sense

### Introduction

Applies to: vehicles with Audi pre sense

The pre sense functions can take action to protect the vehicle occupants and other road users in certain hazardous conditions within the system limits.

- Because the different on-board systems are networked, **pre sense basic** can detect critical situations and take preventive action to protect the occupants.
- The **pre sense front** uses the data of the radar sensor to calculate the probability of an accident ⇒ *page 112*. It can detect an impending collision with vehicles or pedestrians<sup>1)</sup> (subject to general system limitations). In this case, the system warns the driver visually, acoustically and, if necessary, with a short, sharp brake application. If necessary, it can initiate a partial or full brake application in order to reduce the impact speed or, in certain circumstances, to

avoid a collision. In conjunction with pre sense basic, the reversible tensioners on the front seat belts are also applied if necessary. Pre sense front is active even when the adaptive cruise control\* is switched off.

### WARNING

Please observe the general safety warnings ⇒  in *General notes on page 112*.

### Note

- Certain pre sense functions are deactivated when reversing.
- The functions of the pre sense system may also be unavailable if a fault develops in the ESC system or airbag control unit.
- Please note that, if the front passenger's airbag has been deactivated, the reversible belt tensioner on the passenger's side will be deactivated as well.
- Switch off pre sense on private roads and while the vehicle is being loaded onto a car transporter, train or ferry, etc. This prevents the pre sense system from taking action in an inappropriate situation.

## Audi pre sense basic

### Description

Applies to: vehicles with Audi pre sense basic

The pre sense basic functions are activated at speeds above approximately 30 km/h.

The system can activate the following functions in certain situations:

- Seat belt tensioning (e.g. during hard braking): The seat belts on the front seats have reversible tensioners. Provided an accident does not occur, the belts are loosened again slightly and kept ready for activation.
- Initiation of the closure process for the windows and panorama sun roof\* (e.g. if the vehicle understeers or oversteers).

Audi drive select\*: the activation threshold differs according to the mode selected.

<sup>1)</sup> Not available on vehicles for some markets.

## Audi pre sense front

### Description

Applies to: vehicles with Audi pre sense front

In certain situations and at certain speeds, pre sense front can warn you if there is a danger of collision with crossing pedestrians<sup>1)</sup> or stationary, parked and moving vehicles, and can apply the brakes if necessary.

Pre sense front will not react if it is not in a position to detect the danger.

In conjunction with pre sense basic, the following functions may be initiated, depending on how fast the vehicle is travelling:

- Activation of reversible front seat belt tensioners.
- Automatic closing of windows and panorama sun roof\*.

### Warnings and braking

Applies to: vehicles with Audi pre sense front



Fig. 113 Instrument cluster: Collision warning

### Advance warning/acute warning

The system can give visual and audible warnings if it detects a dangerous situation. An **advance warning** can be given if:

- A vehicle in front brakes suddenly.
- Your own vehicle approaches a stationary vehicle at a speed of approx. 30 to 85 km/h.
- Your own vehicle approaches a much slower vehicle travelling in the same direction or a stationary vehicle ahead at a speed of more than approx. 30 km/h.

- A crossing pedestrian<sup>1)</sup> moves into your lane and you are travelling at a speed of approx. 30 to 65 km/h.

If this warning is given, you may need to take evasive action or brake hard to avoid a collision. The driver message **Audi pre sense**  ⇒ Fig. 113 and a warning tone draw your attention to the danger.

In the event of an impending collision with a vehicle, an **acute warning** is also given in the form of a brake jolt. If you do not respond to the acute warning, pre sense front can, subject to general system limitations, apply the brakes with increasing brake force, in order to slow the vehicle down and take the impact out of a potential collision.

### Automatic braking

Pre sense front can initiate an **automatic brake application** at certain speeds just before a collision:

- At up to 85 km/h if vehicles are stopped.
- At any speed if moving or stopping vehicles are detected ahead.
- At up to approx. 65 km/h if pedestrians are crossing<sup>1)</sup>.

### Automatic brake pressure increase

If pre sense front detects that you are not braking hard enough in the event of an impending collision, it will increase the brake pressure, depending on the situation and speed:

- At up to 85 km/h if vehicles are stopped.
- At any speed if moving or stopping vehicles are detected ahead.

### WARNING

The protection provided by pre sense front is still subject to the prevailing physical limits. It is a driver assist function and cannot prevent a collision in every situation. The driver must always intervene personally. As the driver you are always responsible for braking in good time. Do not let the extra safety

<sup>1)</sup> Not available on vehicles for some markets.

provided tempt you into taking any risks when driving – this can cause accidents.

- Please note that pre sense front can give warnings or apply the brakes unexpectedly. Always secure your luggage to prevent damage and possible injury.
- Due to inherent system limitations, false activation of the system is possible.
- Please note that the sensor is not always able to detect all objects which may represent a potential hazard - risk of accident!
- Pre sense front does not react to the following: oncoming traffic in the same lane, stationary or stopped persons, pedestrians crossing the road at an angle, groups of people, animals, or objects that are hard to recognise ⇒ ⚠ in *General notes on page 112*.

### **WARNING**

The pre sense front functions may be restricted or unavailable in situations such as the following:

- If objects such as crash barriers or other vehicles are reflecting additional light.
- At tunnel entrances.
- In heavy fog, rain, road spray or snow.
- If the radar sensor is dirty, frosted, damaged or covered.
- When driving through a corner.
- Applies to: front-wheel drive vehicles: If the ESC system has been partially or fully deactivated.

### **CAUTION**

Impacts or damage to the bumper, wheel arches or underbody can cause misalignment of the sensor. This can impair the function of the pre sense front system. Have the systems checked by a qualified workshop.

### **Note**

- The automatic brake application with increasing brake force can be cancelled by applying the brakes yourself or by pressing the

accelerator firmly or by taking evasive action.

- Applies to: front-wheel drive vehicles: Certain pre sense front functions are deactivated when the ESC offroad mode is switched on and when reversing.
- Applies to: front-wheel drive vehicles: The pre sense is deactivated if you restrict or switch off the ESC ⇒ *page 146*.

## Settings on the infotainment system

Applies to: vehicles with Audi pre sense front/Audi adaptive cruise control

- ▶ Select the following on the infotainment system: **MENU** button > **Car** > left control button > **Driver assist** > **Audi pre sense**.

**System** - The pre sense functions can be switched on/off.

**Advance warning**<sup>1)</sup> - You can switch the advance warning **off** or set the warning time for pre sense front (**early/medium/late**).

Start by setting the advance warning to **early**. If you then find that the system warns you earlier than desired, you can set the advance warning to **medium**. The advance warning should be set to **late** only in exceptional cases, such as during very dynamic driving.

If a system or the advance warning function is switched off, it will be automatically activated again the next time you switch on the ignition<sup>1)</sup>.

## Driver messages

Applies to: vehicles with Audi pre sense

### **Audi pre sense: fault. Please contact workshop**

This message appears if the functions of the pre sense system are impaired. An impairment can occur, for example, if a sensor fails. If the message remains displayed permanently, drive to a qualified workshop soon and have the fault rectified. ▶

<sup>1)</sup> Not available on vehicles for some markets.

### **Audi pre sense: currently restricted. Sensor view restricted due to surroundings.**

This message appears if the radar sensor vision is impaired, e.g. by leaves, snow, heavy road spray or dirt. If necessary, clean the sensor  
⇒ *page 112, Fig. 101.*

### **Audi pre sense: currently restricted**

This message appears in certain situations, e.g. when the ESC is partially or fully deactivated.

### **Audi pre sense: currently restricted. See owner's manual**

This driver message appears if one or more sub-systems, such as the ESC, fails temporarily. If the message is displayed several times, drive to a qualified workshop and have the fault rectified.

### **Audi pre sense: emergency braking system off**

This message appears if the functions of the pre sense system are deactivated via the infotainment system or if the system is not available.

## Audi active lane assist

### Description

Applies to: vehicles with Audi active lane assist

The active lane assist (lane departure warning feature) uses a camera in the windscreen to detect lane markings (subject to general system limitations). If you approach one of the detected lane markings, the system corrects the steering to warn you that the vehicle might be about to cross one of the markings. You can override this steering input at any time. The steering wheel vibrates slightly if you cross a lane marking. The vibration warning must be activated beforehand on the infotainment system. The active lane assist is functional when it detects a demarcation line on at least one side of the lane in which you are driving.

As the system is designed for driving on motorways and other major roads, it is only active above a speed of about 65 km/h (may vary in different export markets).

Applies to: vehicles with Audi side assist

If you operate the turn signals while the active lane assist and side assist are active, the steering will be corrected just before you cross the lane demarcation if the side assist detects vehicles approaching quickly or travelling at about the same speed as your own vehicle and judges the situation to be critical. This intervention is intended to keep the vehicle in the lane.

Applies to: vehicles without Audi side assist

The system does not warn you if you operate the turn signal before crossing a lane marking. In this case, it assumes that you intend to change lanes.

Applies to: vehicles with traffic jam assist

The traffic jam assist can be activated at speeds below approximately 65 km/h if the corresponding conditions have been met ⇒ *page 117.*

### **WARNING**

- The system initiates a corrective steering input to warn the driver that the vehicle is about to leave the lane. As the driver you are always responsible for staying in your own lane.
- The system can assist you to keep the vehicle in the lane, however it is not capable of driving on its own. Never take your hands off the steering wheel.
- In certain situations, e.g. during heavy braking, the system may not correct the steering.
- In certain circumstances, not all of the lane markings may be detected by the camera. A corrective steering input can only be initiated if the system detects a lane marking on the side in question.
- Variations in the road surface or objects on the road may be misinterpreted as lane markings. In this case, the steering may be corrected unexpectedly or not at all.
- The camera's view might be obstructed, for example by vehicles travelling in front, rain, snow, a lot of water on the road, adverse light or dirt on the windscreen. If this happens, the active lane assist may not detect

the lane markings or may respond incorrectly.

- In certain circumstances, for instance if visibility is poor, the setting for the steering input may temporarily be switched from “early” to “late”<sup>1)</sup>.
- In certain driving conditions, such as ruts in the road surface, adverse cambers or side winds, the assistance provided by the steering correction may be insufficient to keep the vehicle in the middle of the lane.
- For safety reasons, the active lane assist must not be used in poor weather or in difficult or slippery road conditions (such as ice, fog, loose grit or gravel, heavy rain, snow, etc.) - risk of accident!

### Switching on/off

Applies to: vehicles with Audi active lane assist



Fig. 114 Turn signal lever: Button for active lane assist

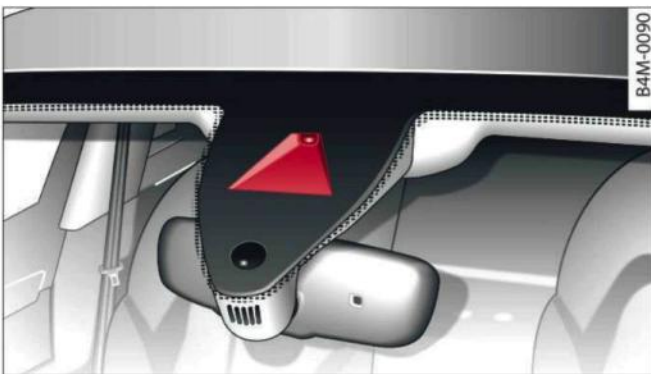

Fig. 115 Windscreen: Camera window for active lane assist

- ▶ Press the button ⇒ Fig. 114 to switch the system on/off. The indicator lamp in the instrument cluster will light up or go out.

| Analogue instrument cluster | Audi virtual cockpit/head-up display* | Meaning on corresponding side  |
|-----------------------------|---------------------------------------|--|
| Green lines<br>↙ ↘          | Green line(s)<br>(left/right)<br>↙ ↘  | The active lane assist is switched on and ready to warn.   |
| -                           | Red line<br>(left/right)<br>↙ ↘       | The active lane assist warns you before you cross the lane demarcation. In addition, the steering wheel vibrates slightly. |
| Yellow lines<br>↙ ↘         | Grey line(s)<br>(left/right)<br>↙ ↘   | The active lane assist is switched on but not ready to warn.   |

The system may be switched on but not ready to warn due to the following reasons:

- There are no lane markings.
- The system cannot detect the relevant lane markings (e.g. temporary markings for road works or markings obscured by snow, dirt, rain or adverse light).
- The vehicle's speed is below 65 km/h, the speed at which the lane assist system is activated (the threshold may vary in different export markets).
- The traffic lane is too narrow or too wide.
- The bend is too tight.
- You have taken your hands off the steering wheel.

### **i** Note

- Make sure that the camera window ⇒ Fig. 115 is not covered with stickers or similar objects. Notes on cleaning ⇒ page 312.

1) This function is not available on all export versions.

- On vehicles for some export markets: once the system is activated, it is "ready" each time the ignition is switched on.

### Instrument cluster display

Applies to: vehicles with Audi active lane assist



**Fig. 116** Instrument cluster: active lane assist switched on and ready to warn

You can use the controls on the multi-function steering wheel to call up the active lane assist display ⇒ *page 15*/⇒ *page 18*.

Information is also provided in the head-up display\*.

| Instrument cluster display       | Meaning on corresponding side  |
|----------------------------------|--|
| Green line(s)<br>(left or right) | The active lane assist is switched on and ready to warn.   |
| Red line<br>(left or right)      | The active lane assist warns you before you cross the lane demarcation. In addition, the steering wheel vibrates slightly. |
| Grey line(s)<br>(left or right)  | The active lane assist is switched on but not ready to warn.   |

### Driver messages in the instrument cluster display

Should the active lane assist be deactivated automatically, the indicator lamp on the display will go out and one of the following messages will appear:

**🚦 🚦 Audi active lane assist: system fault!**

Drive to a qualified workshop soon and have the fault rectified.

**🚦 🚦 Audi active lane assist: currently unavailable. No camera view**

This message is displayed when the camera is no longer functional after the system has continuously failed to detect the lane markings. This can have the following causes:

- The outside of the camera window ⇒ *page 124*, *Fig. 115* is dirty or frosted. Remove dirt or ice from this area of the windscreen.
- The inside of the camera window is misted up. In this case, wait for the camera window to demist before switching on the active lane assist system again.
- Due to the road conditions, the system has not been able to detect the lane markings for a long period. Do not switch the active lane assist system on again before the lane markings are discernible.

**🚦 🚦 Audi active lane assist: currently unavailable**

A temporary fault is preventing the active lane assist system from functioning. Try switching on the active lane assist system again later.

**🚦 🚦 Audi active lane assist: please take over steering.**

This message will appear if you do not steer the vehicle yourself. The active lane assist is switched on but not ready to warn. If the driver still does not react, the system warns additionally with a short sharp application of the brakes and activates the emergency assist\* ⇒ *page 126*.

**⚠️ WARNING**

Please note that the messages only appear with a delay or are not displayed at all on vehicles with additional equipment (such as steering wheel knobs) fitted on the steering wheel. Always keep your hands on the steering wheel.

### Setting the steering input time and vibration warning

Applies to: vehicles with Audi active lane assist

You can change the Audi active lane assist settings on the infotainment system to suit your individual preferences.

- ▶ Select the following on the infotainment system: **MENU** button > **Car** > left control button > **Driver assist** > **Audi active lane assist**.

#### Steering input<sup>1)</sup>

**early:** If this setting is selected, a continuous steering input assists the driver to keep the vehicle in the middle of the lane.

**late:** If this setting is selected, the steering is not corrected until just before a wheel crosses a detected lane marking.

#### Vibration warning

You can switch the additional steering wheel vibration warning on/off.

#### WARNING

When the vibration warning is switched off, no visual warnings are given in the instrument cluster display if you cross a lane marking.

#### Note

Your personal settings are stored automatically and assigned to the remote control key which is being used <sup>1)</sup>.

### Emergency assist

Applies to: vehicles with emergency assist

The emergency assist takes over control of the vehicle in certain situations and can help to prevent accidents. It is an extension of the active lane assist and can use the functions of the adaptive cruise control system ⇒ . The emergency assist is activated when it detects that the driver has stopped steering the vehicle.

### Functions of the emergency assist

The emergency assist monitors the steering activity of the driver. It detects if the driver is inactive and gives repeated visual and audible warnings as well as brake jolts prompting the driver to take proactive control of the vehicle again. The hazard warning lights are also switched on when the first sharp brake jolt is given below a speed of 80 km/h<sup>1)</sup>.

If the driver does not take over, the system intervenes by steering the vehicle (within the limitations of the system) to keep it in lane, and by applying the brakes until the vehicle has stopped\*. In addition, the warning lamp  and a message are displayed.

#### Requirements for using the emergency assist

- The active lane assist must be switched on and ready to warn ⇒ *page 124*.
- The adaptive cruise control must be switched on and activated ⇒ *page 113*.

If any of the requirements for the active lane assist ⇒ *page 123* or adaptive cruise control ⇒ *page 112* are not met, the functionality of the system may be restricted or it may be deactivated automatically.

#### Interrupting the emergency assist

You can interrupt the emergency assist if it reacts when it shouldn't ⇒ :

- Move the steering wheel. Or:
- Press the brake/accelerator. Or:
- Switch off the active lane assist via the button ⇒ *page 117, Fig. 110*.

#### WARNING

- As the driver you are always responsible for controlling the vehicle. Do not let the emergency assist tempt you into taking any risks when driving – this can cause accidents.

<sup>1)</sup> This function is not available on all export versions.



- The purpose of the emergency assist is to assist the driver and to help prevent an accident in case of an emergency. The protection provided by the system is still subject to the prevailing physical limits - risk of accident!
- Due to inherent system limitations, false activation of the system is possible - risk of accident! Interrupt the emergency assist if necessary.
- Please observe the warnings for the adaptive cruise control ⇒  in *General notes on page 112*.

### Note

If the emergency assist is deployed, it will not be available again until the next time the ignition is switched on.

## Audi side assist

### Description

Applies to: vehicles with Audi side assist

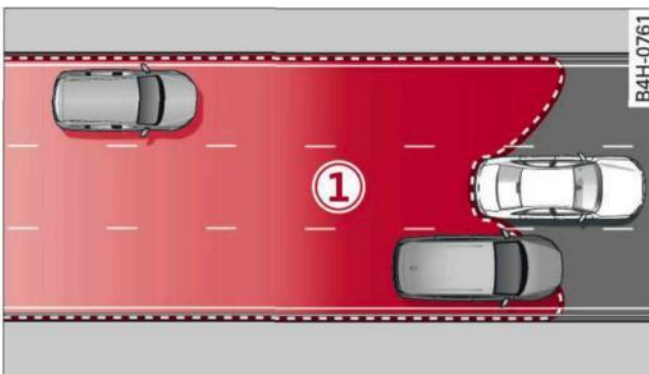



Fig. 117 Area covered by the radar sensors



Fig. 118 Warning lamp on exterior mirror

The side assist function (lane change assist feature) assists the driver in monitoring following traffic and the blind spots on both sides of the

car. Within certain system limits, it warns you if it detects vehicles approaching quickly or traveling at about the same speed as your own vehicle in the area covered by the sensors  ⇒ Fig. 117. If it judges a lane change to be critical, the warning lamp  on the exterior mirror lights up ⇒ Fig. 118.

The warning lamp on the left-hand mirror assists the driver when changing lane towards the left and the warning lamp on the right-hand mirror assists the driver when changing lane towards the right.

### Information mode

As long as you do not operate the turn signal, the side assist will merely *inform* you of the presence of vehicles that it has detected and judges to be critical. In this case, the warning lamp on the relevant exterior mirror will light up at low intensity.

The intensity of the warning lamp in this information mode is kept relatively low, so that it does not distract you while you are looking at the road in front.

### Warning mode

If you operate the turn signal and the warning lamp on the relevant exterior mirror flashes brightly, the side assist is *warning* you of what it judges to be a critical vehicle. Please check the situation in the exterior mirror and by looking back over your shoulder ⇒  in *General notes on page 128*.

Applies to: vehicles with Audi active lane assist

The warning lamp on the relevant mirror may also flash when you have not operated the turn signal. If you come close to a detected lane marking and are in danger of leaving your lane, the side assist warns you of what it judges to be a critical vehicle.

### Note

You can adjust the brightness of the warning lamp on the exterior mirror ⇒ *page 129*.

### General notes

Applies to: vehicles with Audi side assist

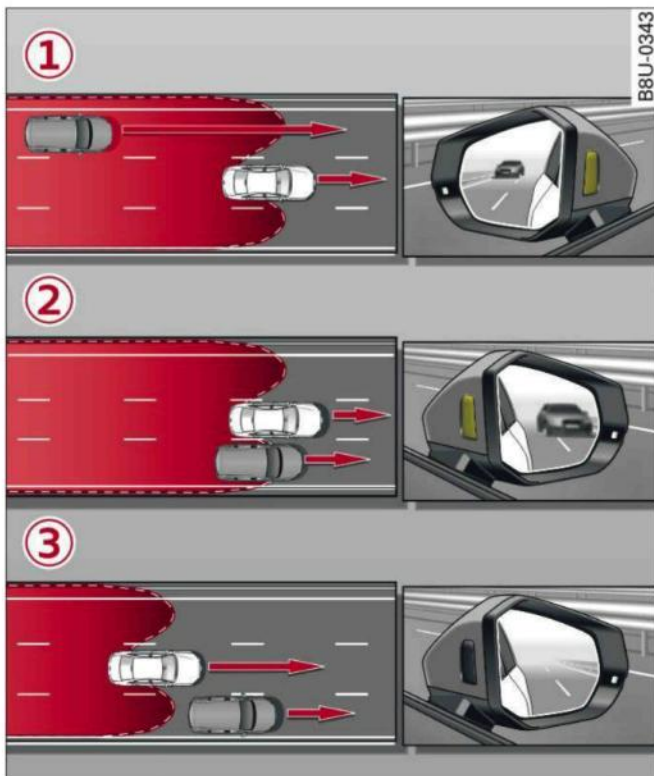

Fig. 119 Driving situations



Fig. 120 Rear of vehicle: Location of the sensors

The side assist is active above a speed of about 15 km/h.

#### ① Vehicles approaching from behind

In certain cases, a vehicle is judged to be critical in the event of a lane change even if it is still some distance away. The faster a vehicle approaches, the earlier the warning will appear on the exterior mirror.

#### ② Vehicles moving at a similar speed

The warning lamp in the relevant exterior mirror will warn you of vehicles that are moving with the flow of traffic at about the same speed as you if they are judged to be critical in the event of a

lane change. In all cases, the side assist will give a warning for the vehicles it has detected at the latest when they enter the “blind spot”.

#### ③ Other vehicles being overtaken

When you are overtaking another vehicle slowly, with a speed differential of less than about 15 km/h, the warning lamp in the exterior mirror will light up as soon as the other vehicle enters your blind spot.

If you are overtaking another vehicle quickly, with a speed differential of more than about 15 km/h, the warning lamp will not light up.

#### System limitations

The radar sensors are designed for normal lane widths and monitor the lanes immediately to the left and right of your vehicle. In certain situations the warning lamp on one of the exterior mirrors may light up even if no vehicle is travelling in an area that could be critical in the event of a lane change. For example:

- When you are travelling in a narrow lane or when you are not travelling in the centre of the lane. In this case the system may monitor another lane and register a vehicle that is *not* in fact travelling in an adjacent lane.
- When you are driving into a bend. The side assist may react to a vehicle two lanes away.
- If the system detects other objects (such as crash barriers, etc).
- In poor weather conditions. The functionality of the side assist is then restricted.

The radar sensors ⇒ Fig. 120 must not be obstructed by stickers, bicycle racks, deposits or any other substances which could impair the function of the system. The side assist must not be used when towing a trailer. For notes on cleaning, please refer to ⇒ page 312.

#### WARNING

- Always watch the road and the area surrounding the vehicle. The side assist feature is not a substitute for the full concentration of the driver. The driver is always responsible for the safety of lane changes and other manoeuvres.

- In certain situations, the system may not function properly, or the functionality of the system may be restricted. For example:
  - If other vehicles are approaching very quickly, or if you are overtaking other vehicles quickly. The warning lamp may not light up in time.
  - In poor weather conditions, such as heavy rain, snow or road spray.
  - If you are travelling in very wide lanes, in tight bends or over crests. The system may not detect vehicles in the adjacent lane because they are outside the area covered by the sensors.

### CAUTION

Impacts or damage to the bumper, wheel arches or underbody can cause misalignment of the sensors. This can impair the functionality of the system. Have the systems checked by a qualified workshop.

### Note

The warning lamps on the exterior mirrors may not be properly visible if tinted foil is affixed to the side windows on the driver's or passenger's side.

### Switching on/off

Applies to: vehicles with Audi side assist

*The system can be switched on and off on the infotainment system.*

The warning lamps in the exterior mirrors light up briefly each time the ignition is switched on to indicate that the system is activated.

- ▶ Select the following on the infotainment system: **MENU** button > **Car** > left control button > **Driver assist** > **Audi side assist**. Select **off** to switch off the system.

### Adjusting brightness of warning lamp

Applies to: vehicles with Audi side assist

*The brightness of the warning lamp can be adjusted on the infotainment system.*

- ▶ Select the following on the infotainment system: **MENU** button > **Car** > left control button > **Driver assist** > **Audi side assist**.

The brightness of the warning lamp in both the information and warning modes is regulated automatically according to the ambient light level. If you are in very dark or very light surroundings when you adjust the brightness of the warning lamp, the automatic brightness control may already have reached the lowest or the brightest setting. In such a case it is possible that you won't notice a difference while you are adjusting the brightness or that you will only notice it once the light surroundings have changed.

Please adjust the brightness of the warning lamp for the information mode so that it does not distract you while you are looking at the road in front. When you change the brightness, the warning lamp on the exterior mirror will light up briefly with the intensity set for the information mode. The intensity of the lamp in the warning mode is linked to the intensity in the information mode and is adjusted automatically.

### Note

- The side assist is not active while the settings are being adjusted.
- Your personal settings are stored automatically and assigned to the remote control key which is being used.

### Rear cross-traffic assist

Applies to: vehicles with rear cross-traffic assist

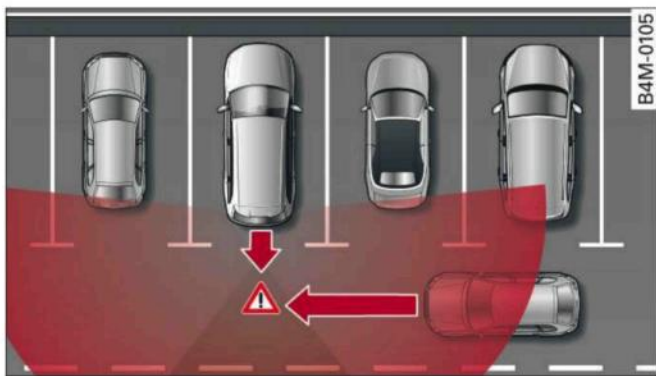

Fig. 121 Example diagram



Fig. 122 Infotainment: Rear cross-traffic assist display

While you are reversing, the rear cross-traffic assist can warn against a potential collision with traffic approaching perpendicular to the rear of the vehicle. The system uses the radar sensors  $\Rightarrow$  page 128, Fig. 120 to monitor the area behind and to the side of the vehicle when you are leaving a parking space. Where possible, it detects objects, such as cars, as they approach the vehicle  $\Rightarrow$  Fig. 121.

If critical cross-traffic is detected when reversing out of a parking space, the system reacts as follows:

- **Graphic display:** A graphic with a red arrow symbol appears on the infotainment display. The arrow indicates the direction from which the object is approaching  $\Rightarrow$  Fig. 122.
- **Warning tone:** A tone may sound continuously as an additional signal when you are reversing.
- **Automatic brake jolt:** A short sharp application of the brakes may also warn against a potential collision with an approaching object.

### Requirements for the use of the rear cross-traffic assist:

- The parking aid must be switched on  $\Rightarrow$  page 134.
- Reverse gear must be engaged.
- The speed must not be higher than approximately 12 km/h.

#### WARNING

- The purpose of the rear cross-traffic assist is to assist the driver; it cannot prevent a collision on its own. The driver must always intervene personally. As the driver you are always responsible for braking in good time.
- Please note that the rear cross-traffic assist may apply the brakes unexpectedly. Always secure your luggage to prevent damage and possible injury.
- After an automatic brake jolt, no further brake jolt will occur within 10 seconds.
- If the rear cross-traffic assist gives an acoustic warning signal, the parking aid may no longer be able to warn you against obstacles it has detected.
- The radar sensor vision can be impaired, e.g. by leaves, snow, heavy road spray or dirt. Clean the area in front of the sensors  $\Rightarrow$  page 128, Fig. 120.

#### WARNING

- The rear cross-traffic assist has certain inherent limitations and cannot warn against an impending collision in every situation:
- It cannot give a warning if the vehicle is so far into a parking space that it is hidden by the vehicles in front and behind.
  - People such as cyclists, joggers, inline skaters and pedestrians may not be detected in certain situations.
  - It cannot give a warning when you are parked at an angle or parallel to the roadside.

#### CAUTION

Please also observe the notes  $\Rightarrow$   in General notes on page 129.

**Note**

- The automatic brake application with increasing brake force can be cancelled by applying the brakes yourself or by pressing the accelerator firmly.
- In certain situations, a warning may be given by the rear cross-traffic assist even if there is no traffic in the critical zone, for instance when parking or manoeuvring the vehicle in reverse.
- The rear cross-traffic assist is deactivated automatically if you deactivate the ESC.
- The rear cross-traffic assist is switched on/off via the parking aid ⇒ *page 134*.
- The system is not available in towing mode.

**Driver messages**

Applies to: vehicles with Audi side assist

Should the side assist be deactivated automatically, a driver message will appear in the instrument cluster display.

**Audi side assist: system fault!**

The system cannot detect vehicles reliably and will be deactivated. The sensors are out of alignment or defective. Have the system checked by a qualified workshop soon.

**Audi side assist: currently unavailable. No sensor vision****Audi side assist: currently unavailable. Sensor view restricted due to surroundings. See owner's manual**

The radar sensors are blocked. The area in front of the sensors must not be obstructed by bicycle racks, stickers, deposits or any other substances. If necessary, clean the area in front of the sensors ⇒ *page 128, Fig. 120*.

**Audi side assist: currently unavailable**

The side assist is temporarily inoperative and cannot be switched on (for instance if the battery is not sufficiently charged).

**Audi side assist: unavailable in towing mode****Audi side assist: unavailable in towing mode**

The side assist function will be switched off automatically after a short time when the electrical connector for the trailer socket is plugged in on vehicles with a factory-fitted towing bracket. If the towing bracket is not factory-fitted the side assist function may not be switched off automatically. The side assist must not be used when towing a trailer.

**PA Rear parking aid: obstacle detection limited**

The rear cross-traffic assist is not available. Either the ESC is switched off or the radar sensors may be obstructed by a bicycle rack, stickers, leaves, snow or similar objects. Switch on the ESC or, if necessary, clean the area in front of the sensors ⇒ *page 128, Fig. 120*. If this message remains displayed, drive to a qualified workshop soon and have the fault rectified.

**Audi drive select****Introduction**

Applies to: vehicles with Audi drive select

Audi drive select allows you to use different set-ups on your vehicle. The modes **efficiency\***, **comfort**, **auto** and **dynamic** allow the driver, for example, to change from a sporty mode to a more comfortable one via the **drive select** button in the centre console or via the infotainment system. In addition, the **individual\*** mode allows you to adapt the vehicle set-up to suit your personal driving style. For example, you might choose to combine a more dynamic engine set-up with a lighter steering response.

**Description**

Applies to: vehicles with Audi drive select

The possible vehicle set-up in each mode depends on which equipment is installed on your vehicle. The engine and steering are basic parts of your vehicle which are always included in the set-up.

**Engine and automatic gearbox\***

The response of the engine and automatic gearbox\* to accelerator pedal movements will be more spontaneous or balanced, depending on

which mode you select. In the performance-oriented dynamic mode, the automatic gearbox changes gear at higher engine speeds.

By contrast, in efficiency\* mode, the automatic gearbox\* selects the next gear at lower engine speeds and the coasting mode is activated ⇒ *page 91*. This helps to reduce fuel consumption.

### Suspension control (Audi magnetic ride)\*

The suspension control uses sensors to collect information on steering movements, braking and acceleration input by the driver, road surface quality, road speed and vehicle loading. With Audi drive select you can choose between dynamic and comfort-oriented suspension set-ups (dynamic and comfort modes), or opt for a more balanced set-up (auto mode).

### Steering

The degree of power assistance can be varied. Various modes are possible ⇒ *page 133*. The light, indirect steering response in comfort mode is particularly suitable on long motorway trips, for instance. The steering has a tighter, more direct feel in dynamic mode.

The steering response is even more agile on vehicles with progressive steering\*.

### Audi adaptive light\*

The adaptive light system adjusts the light distribution according to the mode selected.

### Air conditioner\*

The air conditioner runs in a particularly economical mode when the efficiency\* setting is selected. When this function is selected, **eco\*** is shown in the display of the automatic air conditioner.

### Cruise control system\*

The acceleration response is particularly economical in efficiency\* mode.

### Audi adaptive cruise control\*

The acceleration mode can be varied from comfort to sport by changing the setting in drive select. The setting also determines whether the response of the adaptive cruise control to the driv-

ing style of the driver in front is more balanced or spontaneous. The efficiency\* mode chooses a set-up for maximum economy.

### **i** Note

- On some models the vehicle's maximum speed can only be obtained in the auto and dynamic modes.
- Applies to vehicles with manual gearbox: An **E** appears in the gear-change indicator when efficiency\* mode is activated.
- Applies to vehicles with automatic gearbox: Selector lever position **S** is automatically selected when dynamic mode is activated. **E** is selected in efficiency\* mode.
- Applies to vehicles with automatic gearbox: If you select efficiency\* mode when the selector lever is in position **D**, **E** will automatically appear in the instrument cluster display.
- Applies to vehicles with manual gearbox: If you press the accelerator right down past the point of resistance in **efficiency\*** mode, the engine power is automatically controlled to give your vehicle maximum acceleration.
- Please note that the efficiency\* mode is not available in towing mode.

### Selecting the driving mode

Applies to: vehicles with Audi drive select

*You can choose between efficiency\*, comfort, auto, dynamic and individual\*.*



Fig. 123 Centre console: Button for drive select

- ▶ Press the **drive select** button ⇒ *Fig. 123* repeatedly until the desired mode appears on the instrument cluster/infotainment display. Or: ▶

- ▶ Select the following on the infotainment system: **MENU** button > **Car** > left control button > **Audi drive select**.
- ▶ Select and confirm the desired setting.

You can change the mode while the vehicle is stationary or moving. If traffic conditions permit, take your foot off the accelerator briefly after you change the mode so that the new mode is also activated for the engine.

**efficiency\*** - trims the vehicle to a fuel-saving set-up and helps the driver adopt an economical driving style.

**comfort** - alters the vehicle set-up for a more comfortable ride and is suitable for long motorway trips, for instance.

**auto** - gives an overall impression of a comfortable but dynamic ride and is a good choice of set-up for everyday use.

**dynamic** - gives the vehicle a tighter set-up and is ideal for performance driving.

**individual\*** - ⇒ page 133.



#### WARNING

Always keep an eye on the traffic when using the drive select controls - Risk of accident!

### Configuring individual mode

You can configure your own personal vehicle set-up.

- ▶ Select: **MENU** button > **Car** > **Audi drive select** > **individual** > right control button.

The **individual\*** driving mode will automatically be activated when you have finished configuring the settings.

Your vehicle's equipment and engine determine which systems you can select. The following table provides an overview of the characteristics.

| Systems                       | comfort     | auto     | dynamic |
|-------------------------------|-------------|----------|---------|
| Engine/Gearbox                | Comfortable | Balanced | Dynamic |
| Steering                      | Comfortable | Balanced | Dynamic |
| Audi adaptive cruise control* | Comfortable | Balanced | Dynamic |
| Suspension control*           | Comfortable | Balanced | Dynamic |

#### Note

Your settings in **individual\*** mode are stored automatically and assigned to the remote control key currently in use.

## Parking aids

### General notes

Applies to: vehicles with rear parking aid/parking system plus/reversing camera/park assist

Various systems are available to help you when parking or manoeuvring in tight spaces, depending on the equipment fitted on your vehicle.

The **rear parking aid** gives an acoustic warning if there are any obstacles *behind* the car ⇒ *page 135*.

When you are parking, the **parking system plus** warns you acoustically and optically about obstacles detected *in front of* and *behind* the vehicle ⇒ *page 135*.

The **reversing camera** uses the infotainment system display to show a picture of the area behind the vehicle captured by the camera. This picture helps you to park the vehicle parallel or perpendicular to the roadside. In addition, you are assisted by the functions of the parking system plus ⇒ *page 137*.

The **park assist** helps you to find suitable parking spaces, to manoeuvre the vehicle into spaces parallel or perpendicular to the roadside and to drive out of spaces parallel to the kerb ⇒ *page 139*. It also includes the functions of the parking system plus ⇒ *page 135* and additionally monitors the area at the side of the vehicle **E** ⇒ *page 135*, *Fig. 124*.

#### WARNING

- Always watch the road and the area surrounding the vehicle. The electronic systems cannot replace the full concentration of the driver. The driver is always responsible for safety during parking and all other manoeuvres.
- Please note that certain surfaces, such as clothing fabrics, cannot be detected or displayed by the system - risk of accident!
- The sensors and cameras have blind spots in which neither people nor objects are registered. It is particularly important to ensure that there are no small children or animals near the vehicle - risk of accident!

- Always keep a close watch on the area around the vehicle and make full use of the rear-view mirrors.
- Impacts or damage to the radiator grille, bumper, wheel arches or underbody can cause misalignment of the sensors. This can impair the effectiveness of the parking aids. Have the systems checked by a qualified workshop.

#### CAUTION

- The system may not always be able to detect objects such as the following:
  - Chains, trailer draw bars, posts or fences
  - Objects above the sensors, such as wall protrusions, etc.
  - Objects with certain surfaces or structures, such as wire fences or powder snow
- As your car moves closer to low obstacles, they may disappear from the sensors' field of vision. Please note that you will no longer be warned about these obstacles.
- Remember to maintain sufficient clearance from the kerb to avoid damaging the wheel rims.

#### Note

- In certain situations, a warning may be given by the system even if there is no obstacle within range of the sensors. This can be caused by the following, for instance:
  - Certain road surfaces or long grass
  - External ultrasound sources, e.g. from street cleaning vehicles
  - Heavy rain or snow or dense exhaust fumes
- To familiarise yourself with the system, we recommend that you practise parking in a quiet location or a car park. The weather and light conditions should be good.
- You can change the display and adjust the volume and pitch of the beeps ⇒ *page 143*.
- Please refer to the notes on the use of a towing bracket ⇒ *page 144*.
- There is a slight delay in the picture displayed on the infotainment display.



– To ensure that the acoustic parking aid works properly, the sensors must be kept clean and free of snow and ice.

## Rear parking aid

### Description

Applies to: vehicles with rear parking aid

The rear parking aid is an acoustic parking system.

### Description

Sensors are located in the rear bumper. When the sensors detect an obstacle, you are alerted by acoustic signals (beeps).

Please ensure that the sensors are kept free of stickers, deposits and any other substances which could impair the function of the system. Notes on cleaning ⇒ page 312.

The measuring range of the sensors starts at about:

|      |        |        |
|------|--------|--------|
| Rear | Side   | 0.90 m |
|      | Centre | 1.60 m |

The acoustic signals sound with increasing frequency as you approach the obstacle. A warning tone will sound continuously when the vehicle is less than approx. 0.30 m away from the obstacle. Stop reversing immediately ⇒ ⚠ in General notes on page 134, ⇒ ⚠ in General notes on page 134!

The volume of the warning beeps will be reduced after a few seconds until it is muted if the vehicle remains at a constant distance from a detected obstacle (but not if the obstacle is closer than 0.30 m). If the tone is muted and the obstacle comes closer than before, the tone will sound again. If the tone is muted and the obstacle is further away than before, no tone will sound. Please watch the area surrounding the vehicle when driving off.

### Activating

The parking aid is switched on automatically when reverse gear is engaged. You will hear a brief acknowledgement tone.

## Parking system plus

### Description

Applies to: vehicles with parking system plus/park assist

The parking system plus provides acoustic and visual assistance when parking.

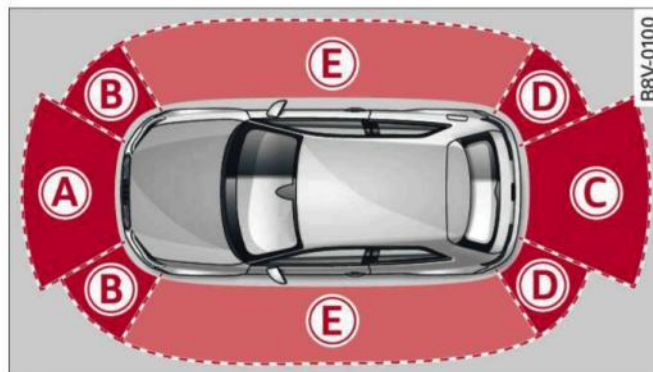

Fig. 124 Diagram

Sensors are located in the front and rear bumpers. When the sensors detect an obstacle, you are alerted by acoustic signals (beeps) and a graphic display.

Please ensure that the sensors are kept free of stickers, deposits and any other substances which could impair the function of the system. Notes on cleaning ⇒ page 312.

Approximate range for each display zone:

|      |                      |
|------|----------------------|
| (A)  | 1.20 m               |
| (B)  | 0.90 m               |
| (C)  | 1.60 m               |
| (D)  | 0.90 m               |
| (E)* | 0.90 m <sup>a)</sup> |

<sup>a)</sup> Applies to vehicles with park assist

The acoustic signals sound with increasing frequency as you approach the obstacle. A warning tone will sound continuously when the vehicle is less than approx. 0.30 m away from the obstacle (or less than approx. 0.20 m away in zone (E)\*). Stop moving immediately ⇒ ⚠ in General notes on page 134, ⇒ ⚠ in General notes on page 134!

The volume of the warning beeps will be reduced after a few seconds until it is muted if the vehicle remains at a constant distance from a detected obstacle (but not if the obstacle is closer than 0.30 m). If the tone is muted and the obstacle

comes closer than before, the tone will sound again. If the tone is muted and the obstacle is further away than before, no tone will sound. Please watch the area surrounding the vehicle when driving off.

### **i** Note

Zone **E**\* is detected and analysed as the vehicle is moving past. When you switch the ignition off and on again or open the door, or after the vehicle has been stationary for a while, the ambient surroundings may have changed. Zone **E**\* is displayed in black on the infotainment display for this reason.

### Switching on/off

Applies to: vehicles with parking system plus/park assist



Fig. 125 Centre console: Button for parking aid



Fig. 126 Infotainment display: Proximity graphic

### Switching on

- ▶ Engage reverse gear, or
- ▶ Press the **P** button in the centre console ⇒ Fig. 125. You will hear a brief acknowledgement tone and the LED in the button will light up.

### Switching off

- ▶ Drive forwards faster than 10 km/h, or
- ▶ Press the **P** button, or

- ▶ Switch off the ignition.

### Automatic activation

The parking aid is activated automatically when the vehicle approaches an obstacle from a distance of approx. 95 cm at speeds below 10 km/h. You will hear the warning beeps when the obstacle is within a distance of approx. 50 cm. If the parking aid is switched off by pressing the **P** button, it is only reactivated automatically if one of the following conditions has been met:

- The vehicle is driven faster than 10 km/h.
- The ignition is switched off and on again.
- The parking brake is applied and released again.
- The selector lever is in position P (automatic gearbox).

### Segments in the graphic display

You can estimate the distance to an obstacle by referring to the segments in front of and behind the vehicle or the segments surrounding the vehicle (on vehicles with park assist\*) ⇒ Fig. 126. The red lines\* indicate the anticipated path of the vehicle, depending on the steering wheel angle. A white segment indicates an obstacle that has been detected beyond the path of travel. Red segments represent objects detected within the path of travel. The closer the vehicle gets to the obstacle the closer the segments move towards the vehicle in the graphic. At the latest when the penultimate segment is highlighted the vehicle has reached the danger (collision) zone. Obstacles within the danger (collision) zone are shown in red, even if they are beyond the path of travel. Stop moving immediately ⇒ **!** in General notes on page 134, ⇒ **!** in General notes on page 134!

## Reversing camera

### Introduction

Applies to: vehicles with reversing camera

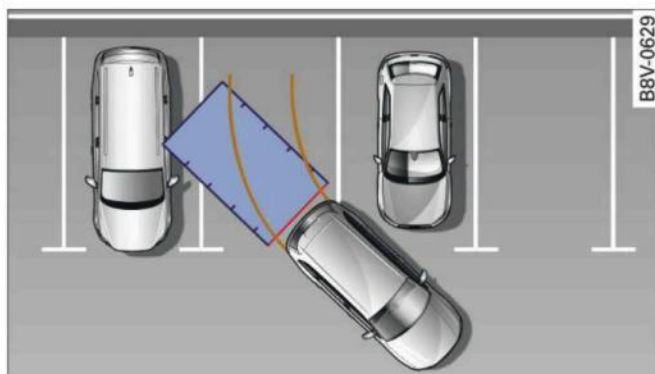

Fig. 127 Diagram: Parking perpendicular to the roadside

The reversing camera assists you by displaying orientation lines when you are parking or manoeuvring the vehicle.

### General notes

Applies to: vehicles with reversing camera



Fig. 128 ①: Area covered by the reversing camera; ②: area NOT covered by the reversing camera (example)



Fig. 129 Boot lid: Location of reversing camera (example)

The reversing camera is located above the rear number plate. Please ensure that the lens of the reversing camera ⇒ Fig. 129 is kept free of deposits and any other substances which could im-

pair the function of the parking aid. Notes on cleaning ⇒ page 312.

① ⇒ Fig. 128 represents the area covered by the reversing camera. Only this area is shown in the picture on the infotainment display. Objects out of range of the camera in area ② do not appear in the picture.

### ⚠ WARNING

- Please observe the safety warnings ⇒ ⚠ in *General notes on page 134*.
- For safety reasons, you should not use the system if the position and installation angle of the reversing camera have been changed, e.g. due to an accident. Have it checked by a qualified workshop.
- Only use the reversing camera to assist you if it is supplying you with a good and clear picture. The quality of the picture can be impaired by adverse light, dirt on the lens or a defect.
- Only use the reversing camera when the boot lid is completely closed. The orientation lines and blue markings are not shown when the boot lid is open. Please make sure that there are no objects mounted to the rear end of the vehicle which could block the view of the reversing camera.
- The camera lens enlarges and distorts the field of vision. Objects on the screen are modified and depicted inaccurately.
- In certain situations, people or objects on the display may appear closer or further away than they really are:
  - Objects which are not touching the ground, such as the bumper of a parked vehicle, a tow-bar or the rear end of a truck. In this case, do not use the orientation lines as a guide.
  - When you are reversing from a horizontal surface up a gradient or down a hill.
  - When approaching protruding objects.
  - When the vehicle has been loaded with a greater load on the rear.

### ⚠ CAUTION

- Please observe the safety warnings ⇒ ⚠ in *General notes on page 134*.
- The orange orientation lines on the infotainment display show the path of the rear end of the vehicle if you were to reverse using the current steering angle. Please note that the front end of the vehicle swings out further than the rear. Please make sure you keep a sufficient distance between the vehicle and any obstacles to make sure that the exterior mirror or edge of the vehicle do not collide with the obstacles.

### Switching on/off

Applies to: vehicles with reversing camera

#### Switching on

- ▶ Engage reverse gear, or
- ▶ Press the **P** button in the centre console ⇒ *page 136, Fig. 125*. You will hear a brief acknowledgement tone and the LED in the button will light up.

#### Switching off

- ▶ Drive forwards faster than 10 km/h, or
- ▶ Press the **P** button, or
- ▶ Switch off the ignition.

### i Note

- The graphic on the right of the display helps identify the critical area of the vehicle.
- You can change the display and adjust the volume of the beeps ⇒ *page 143*.

### Parking perpendicular to the roadside

Applies to: vehicles with reversing camera

*This view can be used when parking your vehicle in a garage or parking bay.*

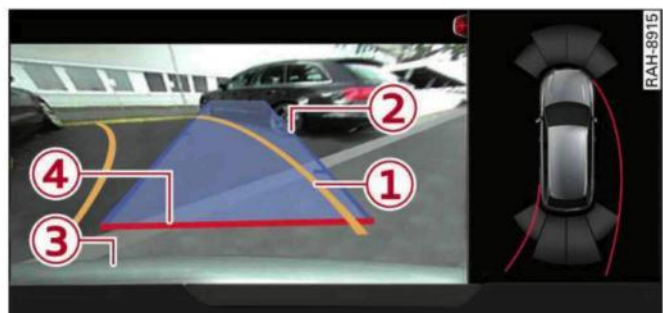

Fig. 130 Infotainment display: Approaching a parking space

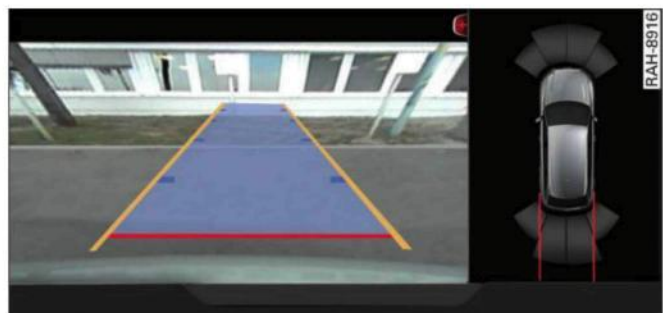

Fig. 131 Infotainment display: Aligning the vehicle

- ▶ Switch on the infotainment system and select reverse gear.
- ▶ The orange orientation lines ① represent the path of the vehicle. Turn the steering wheel until the orange orientation lines are pointing towards the parking space ⇒ *Fig. 130*. You can estimate the distance to an obstacle by referring to the markings ②. Each marking is equivalent to approx. 1 metre. The blue marking is an extension of the vehicle outline and reaches about five metres to the rear of the vehicle.
- ▶ Reverse into the space and adapt the steering angle to the parking space, using the orange lines to assist you ⇒ ⚠ in *General notes on page 137*, ⇒ ⚠ in *General notes on page 138*. ③ represents the rear bumper. Stop moving, at the latest, when the red orientation line ④ is bordering on an obstacle.

### Towing mode

Applies to: vehicles with reversing camera and towing bracket

This view helps you to position the vehicle in front of a trailer.



Fig. 132 Infotainment display: Rear view

Important: The **Trailer view** must be selected ⇒ page 143.

- ▶ You can now position your vehicle in front of the trailer ⇒ ⚠ in General notes on page 137, ⇒ ⚠ in General notes on page 138. The orange orientation line indicates the anticipated path of the tow-bar. You can use the blue lines to estimate the distance to the trailer hitch.

## Park assist

### Description

Applies to: vehicles with park assist

The park assist helps the driver to manoeuvre the vehicle into and out of parking spaces.

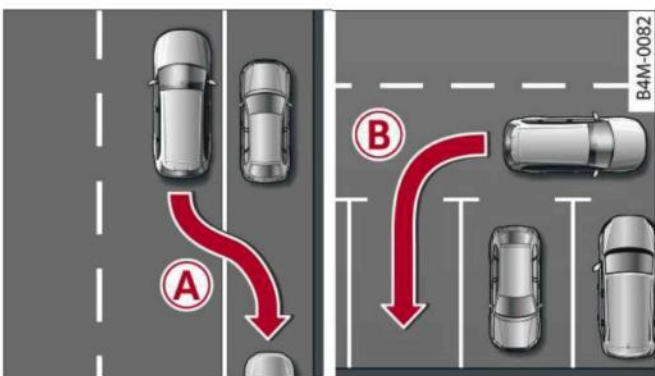

Fig. 133 Diagram: (A) parking in reverse parallel to the roadside, (B) parking in reverse perpendicular to the roadside

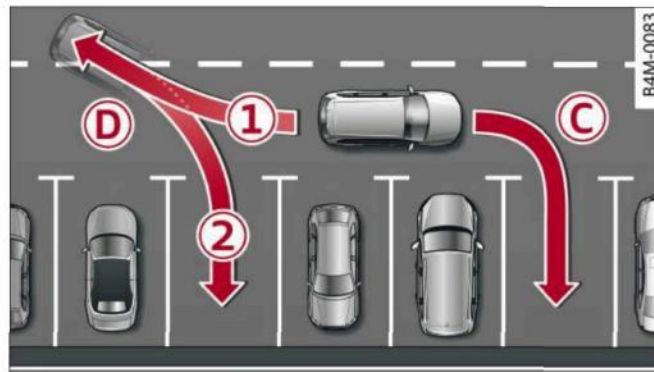

Fig. 134 Diagram: (C) parking forwards perpendicular to the roadside without driving past, (D) parking forwards perpendicular to the roadside after driving past

The park assist helps you to find suitable parking spaces and to manoeuvre the vehicle into them. You can reverse into a parking space either parallel (A) or perpendicular (B) to the roadside or drive forwards out of a parallel space. In addition, you can drive forwards into a perpendicular parking space if you have already positioned the front of the vehicle in the space (C) or have already driven past the space (D). In the case of (D), the vehicle reverses (1), manoeuvres into the correct position and drives forwards into the parking space (2).

The parking space can be located between two vehicles or behind one vehicle. The park assist takes over the steering while the driver is parking the vehicle in the usual way.

The park assist includes the functions of the parking system plus ⇒ page 135, which assists you during the parking manoeuvre.

The park assist sensors are located on the sides of the front and rear bumpers. Please ensure that the sensors are kept free of stickers, deposits and any other substances which could impair the function of the system. Notes on cleaning ⇒ page 312.

In short parking spaces, the parking aid warning tone will sound continuously when the vehicle is less than approx. 0.20 m away from the obstacle. Stop moving immediately!

### ⚠ WARNING

– Please observe the safety warnings ⇒ ⚠ in General notes on page 134.

- Please note that the park assist only handles the steering. As the driver you are always responsible for braking and accelerating.
- It is the driver's responsibility to decide whether a parking space shown in the display is suitable for the vehicle.
- The front of the vehicle swings out during the parking manoeuvre. Please take all necessary measures to ensure that other road users are not endangered.
- The steering wheel turns rapidly on its own when parking the vehicle and leaving the space. Injury may result if a person reaches between the spokes on the steering wheel when it is turning.

### CAUTION

- Please observe the safety warnings  in *General notes on page 134*.
- In certain situations, the park assist will guide the vehicle onto or across the kerb, for instance if other vehicles are parked on the kerb. You should always be ready to take over the steering wheel in order to prevent damage to the tyres and/or wheel rims.
- Certain conditions in and around the parking space can cause unexpected results when parking.
  - Pillars, posts, etc.
  - Loose gravel, snow, ice, etc.

### Note

- The electronic stabilisation control (ESC) must not be switched off during the parking manoeuvre  $\Rightarrow$  *page 146*.
- The park assist cannot be used to park the vehicle on tight bends.
- The park assist cannot be used to park the vehicle if a trailer is attached and the electrical connector for the trailer socket is plugged in.

## Switching on and off

Applies to: vehicles with park assist

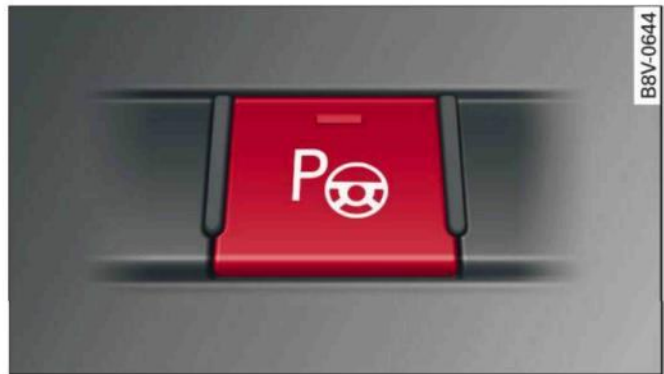



Fig. 135 Centre console: Button for park assist



Fig. 136 Infotainment system: Looking for a parking space

- ▶ Press the **P**  button  $\Rightarrow$  *Fig. 135* to switch on the park assist. The LED in the button will light up and the infotainment display will show the vehicle looking for a parking space  $\Rightarrow$  *Fig. 136*.
- ▶ To switch off the park assist, press the **P**  button. The LED in the button will go out.

### Note

When a parking space is detected, the system automatically suggests a particular parking mode. You can change the suggested selection.

## Looking for a parking space

Applies to: vehicles with park assist



Fig. 137 Infotainment display: Parking space detected

Important: For the best parking result, you should maintain a distance of approx. 1 metre to the row of parked cars.

- ▶ To switch between parallel **A** perpendicular forwards **B** and perpendicular in reverse **C** parking modes, turn the rotary pushbutton to select the desired mode. The system only shows parking modes that are currently possible.
- ▶ Operate the turn signal. The desired side of the road will be scanned.
- ▶ To park parallel to the roadside, drive forwards at not more than 30 km/h. Or:
- ▶ To park perpendicular to the roadside, drive forwards at not more than 20 km/h.
- ▶ The system will display a parking space when it finds one ⇒ Fig. 137. Please check that the parking space is suitable for your vehicle.
- ▶ To park using the system, follow the instructions on the display.

If you exceed a speed of about 50 km/h, the park assist will be switched off.

The park assist will display a parking space only if it is long and wide enough for the vehicle.

**i Note**

- You can select any one of the parking options found. The potential parking space is displayed until you have driven too far away from it.
- You can activate the park assist after you have already driven past a parking space (as long as you were driving slowly enough). To do so, press the **P** button and operate the turn signal.
- The system displays the right or left side of the road, depending on which turn signals you operate.
- The best parking results will be achieved if you position the vehicle as parallel as possible to the line of parked cars or the kerb before you start the actual parking manoeuvre.
- If there are suitable parking spaces on both sides of the road (for instance on a one-way street), you can change the direction of the

turn signals to park on the other side, even if you have already activated the park assist.

**Starting a parking manoeuvre**

Applies to: vehicles with park assist

*The driver is responsible for parking the vehicle.*



Fig. 138 Infotainment system: Prompt to continue reversing (example: parking parallel to the roadside)

- ▶ Drive forwards until the instructions for the automatic parking manoeuvre appear on the infotainment display ⇒ Fig. 138 ⇒ **⚠** in Description on page 139, ⇒ **!** in Description on page 140. A **P** will appear in the intended parking space as soon as the vehicle reaches the correct position.
- ▶ If necessary, you can use the rotary pushbutton to change the parking mode in order to take a different approach to the parking space.
- ▶ The park assist is ready when the message **Please select reverse gear and let go of the steering wheel** appears on the infotainment display.
- ▶ After stopping for a moment, select reverse gear.
- ▶ Take your hands off the steering wheel.
- ▶ Watch the road. When the road is clear, press the accelerator gently ⇒ **⚠** in Description on page 139, ⇒ **!** in Description on page 140.
- ▶ Follow the instructions on the display ⇒ page 142 and the acoustic warning tones until the parking manoeuvre is complete. The arrows on the vehicle show the required direction of travel.

The park assist automatically steers the vehicle into the parking space while the driver operates the pedals. The maximum parking speed is 7 km/h. The park assist will be deactivated if you drive too fast or move the steering wheel by hand. To ▶

continue the parking manoeuvre, press the **P** button again. The park assist will reappear on the display.

### Note



You can cancel the direction of travel given by the system before parking by shifting between forwards/reverse gear. The system will then calculate the further path and steering directions for the manoeuvre based on the position of the vehicle.

### Driving out of a parking space parallel to the roadside

Applies to: vehicles with park assist

*The driver is responsible for manoeuvring the vehicle out of the parking space.*

If the vehicle is parked parallel to the roadside, the park assist can help you to drive out of the parking space.

- ▶ Start the engine.
- ▶ Press the **P** button ⇒ *page 140, Fig. 135*.
- ▶ Wait until the following text appears on the infotainment display: **Specify direction with turn signal to leave parking space**.
- ▶ Operate the appropriate turn signal. The message **Start automatic unparking procedure** will appear.
- ▶ Take your hands off the steering wheel.
- ▶ Press the rotary pushbutton to start automatic unparking.
- ▶ Watch the road. When the road is clear, press the accelerator gently ⇒  in *Description on page 139*, ⇒  in *Description on page 140*.
- ▶ Follow the instructions on the display ⇒ *page 142* and the acoustic warning tones until you are clear to leave the parking space.
- ▶ Drive in the direction specified by the arrows on the vehicle.
- ▶ The procedure is over when no more manoeuvring is necessary in order to drive out of the space. Take over the steering.

The park assist automatically steers the vehicle out of the parking space while the driver operates the pedals. The maximum manoeuvring speed is 5 km/h. The park assist will be deactivated if you

drive too fast or move the steering wheel by hand. To continue the parking manoeuvre, switch the engine off/on. Then press the **P** button again. Alternatively, drive out of the parking space without using the park assist.

### Driver messages

Applies to: vehicles with park assist

 **Park assist: cancelled. Steering input detected. Continue steering vehicle!**

The steering assistant has been deactivated because the driver has intervened in the steering. To continue the parking manoeuvre, press the **P** button again.

 **Park assist: time limit exceeded**

 **Park assist: cancelled. Time limit exceeded. Continue steering vehicle!**

The parking manoeuvre was not completed within about six minutes after the park assist was activated. To continue the parking manoeuvre, press the **P** button again.

 **Park assist: cancelled. Speed too high. Continue steering vehicle!**

You were driving too fast into the parking space. Do not drive faster than 7 km/h.

 **Park assist: cancelled. Stabilisation control (ESC) input. Continue steering vehicle!**

The ESC has intervened. Take over the steering. Finish parking without the park assist or drive out of the parking space.

 **Park assist: currently unavailable. Stabilisation control (ESC) off**

The ESC has been switched off. The ESC must be switched on before the park assist can be used.

 **Park assist: fault. Please contact workshop**

 **Park assist: fault. Continue steering vehicle! Please contact workshop**

Please contact a qualified workshop. The park assist cannot be used to park the vehicle if a system fault occurs.

 **Park assist: currently unavailable** ▶



**P<sub>OFF</sub>** **Park assist: currently unavailable. Continue steering vehicle!**

The park assist cannot be used to park the vehicle. Try repeating the parking manoeuvre or switching the ignition off and on again.

**P<sub>OFF</sub>** **Park assist: ended. Please take over steering and continue driving**

The park assist has finished manoeuvring the vehicle out of the parking space. Please take over the steering.

**P<sub>OFF</sub>** **Park assist: cancelled. Space too small. Continue steering vehicle!**

The park assist cannot be used to park the vehicle in this space. Park the vehicle without using the park assist or look for a bigger space.

**P<sub>OFF</sub>** **Park assist: cancelled. Obstacle detected. Please take over steering.**

The park assist has interrupted the parking manoeuvre to avoid a collision between the vehicle and an obstacle.

**P<sub>OFF</sub>** **Park assist: ended**

**P<sub>OFF</sub>** **Park assist: ended. Please take over steering.**

The park assist has finished the parking manoeuvre.

**P<sub>OFF</sub>** **Park assist: stabilisation control (ESC) input**

The parking space indicated has been rejected because the ESC has intervened.

**P<sub>OFF</sub>** **Park assist: currently unavailable. Towing mode**

The park assist cannot be used to park the vehicle when towing a trailer.

**P<sub>OFF</sub>** **Park assist: not stopped long enough**

After you select reverse gear, the vehicle has to remain stationary for a moment so that the park assist can activate the steering. Follow the directions given in the display.

**P<sub>OFF</sub>** **Park assist: cancelled. Assist function unavailable for leaving parking space. Space too small**

The assist function is unable to automatically steer the vehicle out of the parking space because the space is too small. Manoeuvre the vehicle out of the parking space without using the park assist.

**P<sub>OFF</sub>** **Park assist: cancelled. Continue steering vehicle!**

The park assist has interrupted the parking manoeuvre.

## Settings for parking aid

Applies to: vehicles with rear parking aid/parking system plus/reversing camera/park assist

*You can change the settings for these functions on the infotainment system.*

- ▶ Select the following on the infotainment system: **MENU** button > **Car** > left control button > **Driver assist** > **Parking aid**. Or:
- ▶ Select the right control button\* on the infotainment system when the parking aid is activated.

**End\*** - To cancel the parking aid

**Activate automatically** - To switch automatic activation on/off

**Front volume\*** - Volume for the front and side\* zones

**Rear volume** - Volume for the rear zone

**In-car entertainment fader** - The volume of the current audio or video source is reduced when the parking aid is switched on.

You will hear a short test tone each time you make a new setting.

**Trailer view\*** - To display the trailer view

### Note

- Some of the menus can only be called up via the right control button when the parking aid is activated.
- The volume and automatic activation settings are automatically stored and assigned to the remote control key in use.

### Fault warnings

Applies to: vehicles with rear parking aid/parking system plus/reversing camera/park assist

 **Rear parking aid: fault. Obstacles cannot be detected**

 **Front parking aid: fault. Obstacles cannot be detected**

 **Parking aid: fault. Obstacles cannot be detected**

If any of these messages appears, a system malfunction has occurred. The LED in the  button will flash in addition when the system is activated. The corresponding message will then only appear when you activate the parking aid manually with the button.

 **Rear parking aid: obstacle detection limited**

The rear cross-traffic assist\* ⇒ *page 130, Rear cross-traffic assist* is not available. Either the ESC is switched off or the radar sensors may be obstructed by a bicycle rack, stickers, leaves, snow or similar objects. Switch on the ESC or, if necessary, clean the area in front of the sensors ⇒ *page 128, Fig. 120*. If this message remains displayed, drive to a qualified workshop soon and have the fault rectified.

**Parking system plus\* / park assist\***

If a sensor or loudspeaker malfunctions, the  symbol will be shown on the infotainment display in front of or behind the vehicle. If a rear sensor malfunctions, obstacles will only be displayed in zones **(A)** and **(B)** ⇒ *page 135, Fig. 124*. If a front sensor malfunctions, obstacles will only be displayed in zones **(C)** and **(D)**.

### Towing bracket

Applies to: vehicles with rear parking aid/parking system plus/reversing camera/park assist and towing bracket

When the trailer socket is connected, the rear and side\* parking sensors are NOT activated when you select reverse gear or press the  button. This results in the following restrictions:

**Rear parking aid\***

There is no distance warning.

**Parking system plus\* / park assist\***

There is no rear or side\* distance warning. However, the system will still give a warning when obstacles are detected while driving forwards. The proximity graphic will switch over to towing mode.

**Reversing camera\***

There is no rear or side\* distance warning. However, the system will still give a warning when obstacles are detected while driving forwards. The proximity graphic will switch over to towing mode. The image of the reversing camera will then be shown without orientation lines and blue area markings.



#### Note

Towing brackets which are not factory-fitted can restrict or impair the function of the parking aid.

## Intelligent technology

### Electronic stabilisation control (ESC)

#### Description

The electronic stabilisation control (ESC) increases the car's stability. It reduces the tendency to skid and improves the stability and roadholding of the vehicle. The ESC detects critical handling situations, such as understeer, oversteer and wheelspin on the driven wheels. It stabilises the vehicle by braking individual wheels or by reducing the engine torque. The indicator lamp  in the instrument cluster starts flashing as soon as the ESC intervenes.

The following systems are integrated in the ESC:

#### Anti-lock brake system (ABS)

ABS prevents the wheels from locking up under braking until the vehicle has reached a virtual standstill. You can continue to steer the vehicle even when the brakes are on full. Keep your foot on the brake pedal and do not pump the brakes. You will feel the brake pedal pulsate while the anti-lock brake system is working.

#### Brake assist system

The brake assist system can shorten the braking distance. The braking force is automatically boosted if you press the brake pedal quickly in an emergency. You must keep pressing the brake pedal until the danger has passed. On vehicles with adaptive cruise control\*, the response of the brake assist system will be more sensitive if you are too close to the vehicle in front.

#### Traction control system (ASR)

In the event of wheelspin, the traction control system reduces the engine torque to match the amount of grip available. This helps the car to start moving, accelerate or climb a gradient.

#### Electronic differential lock (EDL)

When the EDL detects wheelspin, it brakes the spinning wheel and directs the power to the other driven wheel (or wheels on quattro\* versions). This function is not available at high speeds.

To prevent the disc brake of the braked wheel from overheating, the EDL cuts out automatically if subjected to excessive loads. The vehicle can still be driven. The EDL will switch on again automatically when the brake has cooled down.

#### Steering recommendation

The ESC helps to stabilise the vehicle by changing the steering wheel torque.

#### Trailer stabilisation system

Applies to: vehicles with trailer stabilisation system

Trailers have a tendency to sway. If the ESC detects that the trailer is swaying and this is affecting the towing vehicle, it will automatically brake the vehicle in order to stabilise the trailer  
⇒ page 97.

#### Selective wheel torque control

Selective wheel torque control intervenes when cornering by braking the wheel(s) on the inside of the bend individually as required. This enables precision cornering.

#### Multicollision brake assist system

The “multicollision brake assist system” can help to reduce the risk of skidding and further collisions during an accident. If the airbag control unit detects that a collision has taken place upwards of a certain speed, the vehicle is braked by the ESC.

The vehicle will not be braked automatically if:

- the driver presses the accelerator,
- or the ESC, the brake system or the vehicle's electrical system are not fully functional.



#### WARNING

- The grip provided by the ESC and the integrated systems is still subject to the physical limits of adhesion. Always bear this in mind, especially on wet or slippery roads. If you notice the systems cutting in, you should reduce your speed immediately to suit the road and traffic conditions. Do not let the extra safety provided tempt you into taking any risks when driving – this can cause accidents.

- Remember that the accident risk always increases if you drive fast, especially in corners or on a wet or slippery road, or if you follow too close behind the vehicle in front of you. Please bear in mind that even the ESC and the integrated systems cannot compensate for the increased accident risk.
- When accelerating on a uniformly slippery surface (for instance all four wheels on ice or snow), press the accelerator gradually and carefully. The driven wheels may otherwise start to spin (in spite of the integrated

control systems), which would impair the car's stability and could lead to an accident.

**i Note**

- The ABS and ASR systems can only work properly if all four tyres have a similar degree of wear. Any differences in the rolling radius of the tyres can cause the system to reduce engine power when this is not desired.
- The systems can make noises when they intervene.

**Switching on/off**

The ESC is switched on automatically when the engine is started.

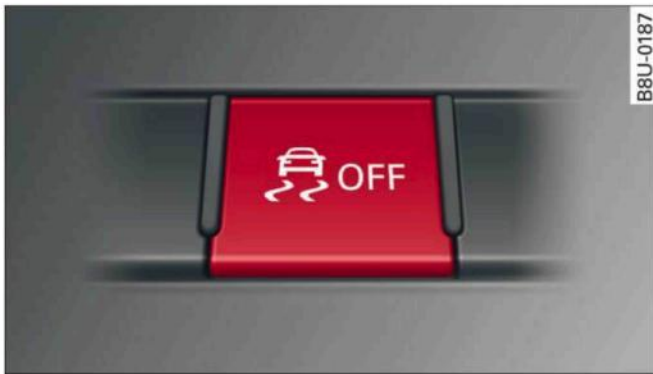

Fig. 139 Centre console (top): ESC button

In the following special situations, it may be advisable to switch on off-road mode to allow a certain amount of wheelspin:

- Rocking the car backwards and forwards to free it
- Driving in deep snow or on loose surfaces
- Driving with snow chains
- Driving on rough terrain when much of the car's weight is lifted off the wheels (axle articulation)
- Braking on unsurfaced tracks when driving downhill

The ESC operates in several levels. Depending on which level is selected, the stabilising function of the ESC is restricted or switched off, and the vehicle is stabilised to a greater or lesser degree.

For your own safety you should switch off the off-road mode in time.

|                         | Off-road mode on  | ESC/ASR off   | Off-road mode off or ESC/ASR on   |
|-------------------------|---|---|---|
| <b>Characteristics</b>  | The stabilising function of the ESC and traction control system (ASR) is restricted ⇒ | The stabilisation function is no longer available ⇒ . ESC and traction control system (ASR) are switched off. | The stabilising function of the ESC and traction control system (ASR) is fully available again. |
| <b>Operation</b>        | Press the  button briefly.  | Press the  button for longer than 3 seconds.  | Press the  button again.  |
| <b>Indicator lamps</b>  | lights up.  | and <b>ESC OFF*</b> light up.   | goes out, or  and <b>ESC OFF*</b> go out.   |
| <b>Driver messages*</b> | <b>Stabilisation control (ESC): offroad. Warning! Restricted stability</b>            | <b>Stabilisation control (ESC): off. Warning! Restricted stability</b>  | <b>Stabilisation control (ESC): on</b>  |

**! WARNING**

You should switch on the off-road mode or switch off the ESC/traction control system (ASR) only if your driving ability and the traffic conditions allow you to do so safely - danger of skidding!

- The stabilising function is restricted when off-road mode is switched on. The driven wheels may start to spin, causing the vehicle to lose grip, in particular on slippery or wet roads.
- When the ESC/traction control system (ASR) is switched off, the vehicle will not be stabilised.

## Brakes

### New brake pads

New brake pads do not give full braking effect for the first 400 km, they must first be “bedded in”. However, you can compensate for the slightly reduced braking effect by applying more pressure on the brake pedal. Avoid placing a heavy load on the brakes during the running-in period.

### Wear

The rate of wear on the **brake pads** depends a great deal on how you drive and the conditions in which the vehicle is operated. Negative factors are, for instance, city traffic, frequent short trips or hard driving with abrupt starts and stops.

### Noises

Brake noise may develop in certain situations, depending on the speed, braking force and ambient conditions (such as temperature and relative humidity).

### Effect of moisture and salt

In certain conditions, such as in heavy rain, early morning dew, or after washing the car or driving through water, the full braking effect can be delayed by moisture (or in winter by ice) on the discs and brake pads. The brakes should be “dried” by pressing the pedal to restore full braking effect.

When you are driving at higher speeds with the windscreen wipers on, the brake pads are very briefly brought into contact with the brake discs. This automatic process which goes unnoticed by the driver is carried out at regular intervals and is intended to improve braking response in wet conditions.

The effectiveness of the brakes can also be temporarily reduced if the car is driven for some distance without using the brakes when there is a lot of salt on the road in winter. The layer of salt that accumulates on the discs and pads can be removed with a few cautious brake applications.

### Corrosion

There may be a tendency for dirt to build up on the brake pads and corrosion to form on the discs if the car is used infrequently, or if you only drive low mileages without using the brakes very much.

If the brakes are not used frequently, or if corrosion has formed on the discs, it is advisable to clean off the pads and discs by braking firmly a few times from a moderately high speed ⇒ .

### Faults in the brake system

If the brake pedal travel should ever increase *suddenly*, this may mean that one of the two brake circuits has failed. Drive immediately to the nearest qualified workshop and have the fault rectified. On the way to the dealer, be prepared to use more pressure on the brake pedal and allow for longer stopping distances.

### Low brake fluid level

Malfunctions can occur in the brake system if the brake fluid level is too low. The brake fluid level is monitored electronically.

### Brake servo

The brake servo amplifies the pressure you apply to the brake pedal. It only works when the engine is running. ►

### **WARNING**

- When applying the brakes to clean off deposits on the pads and discs, select a clear, dry road. Be sure not to inconvenience or endanger other road users; do not risk an accident.
- Never let the car coast with the engine switched off (this can cause accidents).

### **CAUTION**

- Never let the brakes “drag” by leaving your foot on the pedal when you do not really intend to brake. This overheats the brakes, resulting in longer stopping distances and greater wear.
- Before driving down a long, steep gradient, it is advisable to reduce speed and select a lower gear. In this way you will make use of the engine braking effect and relieve the load on the brakes. If you still have to use the brakes, it is better to brake firmly at intervals than to apply the brakes continuously.

### **Note**

- If the brake servo is out of action, you must apply considerably more pressure to the brake pedal than you normally would.
- If you wish to equip the car with accessories such as a front spoiler or wheel covers, it is important that the flow of air to the front wheels is not obstructed, otherwise the brakes can overheat.

## Electro-mechanical power steering

*Electro-mechanical power steering assists the driver when steering.*

The degree of power assistance is adapted *electronically*, depending on the speed.

### Warning/indicator lamps and driver messages

 **Do not drive vehicle: steering defective**

If the warning lamp lights up permanently and the message appears, there may be a power steering failure.



Stop the vehicle in a safe place as soon as possible. Do **NOT** drive on. Obtain professional assistance.

### **Steering malfunction: you can continue driving**

If the indicator lamp lights up, the steering response may be heavier or lighter than usual. In addition, it is possible that the steering wheel will be off centre when driving in a straight line.

Drive slowly to a qualified workshop and have the fault rectified.

### **Note**

You can drive on if the warning/indicator lamp  or  lights up only briefly.

## Four-wheel drive (quattro)

Applies to: vehicles with four-wheel drive

*On quattro models the engine power is distributed to all four wheels.*

### General notes

On four-wheel drive vehicles, the engine power is distributed to all four wheels. The distribution of power is controlled automatically according to your driving style and the road conditions. Also refer to ⇒ *page 145, Electronic stabilisation control (ESC)*.

The four-wheel drive is specially designed to complement the superior engine power of your Audi. This combination gives the car exceptional handling and performance capabilities - both on normal roads and in more difficult conditions, such as snow and ice. Even so (or perhaps especially for this reason), it is important to observe certain safety points ⇒ .

### Winter tyres

Thanks to its four-wheel drive, your car will have plenty of *traction* in winter conditions, even with ►

the standard tyres. Nevertheless, we still recommend that winter tyres or all-season tyres should be fitted *on all four wheels* when winter road conditions are expected, mainly because this will give a better *braking response*.

### Snow chains

On roads where snow chains are mandatory, this also applies to cars with four-wheel drive  
⇒ *page 309, Snow chains*.

### Replacing tyres

On vehicles with four-wheel drive, all four tyres must have the same rolling circumference. Also avoid using tyres with varying tread depths  
⇒ *page 305, New wheels or tyres*.

### Off-roader?

Some models do not have enough ground clearance to be used on rough tracks and uneven terrain, so it is best to avoid off-road driving.

#### WARNING

- Even with four-wheel drive, you should always adjust your speed to suit the conditions. Do not let the extra safety provided tempt you into taking any risks when driving – this can cause accidents.
- The braking ability of your car is limited by the grip of the tyres. In this respect, your car is no different from a car without four-wheel drive. So do not be tempted to drive too fast on icy or slippery roads just because the car still has good acceleration in these conditions – risk of accident!
- On wet roads bear in mind that the front wheels may start to “aquaplane” and lose contact with the road if the car is driven too fast. If this should happen, there will be no sudden increase in engine speed to warn the driver, as with a front-wheel drive car. So do not drive too fast in the wet: adjust your speed to suit the conditions (accident risk).

## Power management

### This system helps to ensure reliable starting

*The power management controls the distribution of electrical energy and thus helps to ensure that there is always enough power available to start the engine.*

If a vehicle with a conventional electrical system is left parked for a long time, the vehicle battery will gradually lose its charge because certain electrical equipment (such as the immobiliser) continues to draw current even when the ignition is off. In some cases there may not be enough power available to start the engine.

Your vehicle is equipped with an intelligent power management system to control the distribution of electrical energy. This significantly improves reliability when starting the engine, and also prolongs the life of the vehicle battery.

The main functions incorporated in the power management system are **battery diagnosis**, **residual current management** and **dynamic power management**.

### Battery diagnosis

The battery diagnosis function constantly registers the condition of the vehicle battery. Sensors detect the battery voltage, battery current and battery temperature. This enables the system to calculate the current power level and charge condition of the vehicle battery.

### Residual current management

The residual current management reduces power consumption while the vehicle is parked. It controls the supply of power to the various electrical components while the ignition is switched off. The system takes the battery diagnosis data into consideration.

Depending on the power level of the vehicle battery, the individual electrical components are switched off one after the other to prevent the vehicle battery from losing too much charge and to ensure that the engine can be started reliably. ►

### Dynamic power management

While the vehicle is moving, this function distributes the available power to the various electrical components and systems according to their requirements. It ensures that on-board systems do not consume more electrical power than is being generated, and thus maintains the maximum possible vehicle battery power level.

#### Note

- The power management system is not able to overcome the given physical limits. Please remember that the power and life of the vehicle battery are limited.
- If the indicator lamp  ⇒ *page 31* appears, the starting ability may be impaired.

### Points to remember

*Starting ability has first priority.*

Short trips, city traffic and low temperatures all place a heavy load on the vehicle battery. In these conditions a large amount of power is consumed, but only a small amount is supplied. The situation is also critical if electrical equipment is in use when the engine is not running. In this case power is consumed when none is being generated.

In these situations you will be aware that the power management system is intervening to control the distribution of electrical power.

### When the vehicle is parked for long periods

If you do not drive your vehicle for a period of several days or weeks, the power management will gradually shut off the on-board systems one by one, or reduce the amount of current they are using. This limits the amount of power consumed and helps to ensure reliable starting even after a long period. Certain convenience features, such as remote control unlocking, may not be available. These functions will be restored when you switch on the ignition and start the engine.

### With the engine switched off

If you listen to the radio or use the other infotainment functions when the engine is not running, this will discharge the vehicle battery.

The infotainment display will show a warning message before the battery power drops to a level where the starting ability is impaired. This message warns you that the system you are using will soon be switched off automatically. You should therefore start the engine if you wish to continue using the system.

### When the engine is running

Although the alternator generates electrical power, the vehicle battery can still become discharged while the vehicle is being driven. This can occur when a lot of power is being consumed but only a small amount supplied, especially if the vehicle battery is not fully charged initially.

To restore the necessary energy balance, the system will then temporarily shut off the electrical components that are using a lot of power, or reduce the current they are consuming. Heating systems in particular use a large amount of electrical power. If you notice, for instance, that the seat heating\* or the rear window heater is not working, they may have been temporarily switched off or regulated to a lower heat output. These systems will be available again as soon as sufficient electrical power is available.

You may also notice that the engine runs at a slightly faster idling speed. This is quite normal, and no cause for concern. The increased idling speed allows the alternator to meet the greater power requirement and charge the vehicle battery at the same time.

## Information saved in the control units

The vehicle is fitted in the factory with electronic control units that, among other things, control the engine and the gearbox. The control units also monitor the exhaust system and the airbags.

The control units continually analyse data relevant to the vehicle while you are driving. In the



event of faults or anomalies in the vehicle data, only these data are saved. As a rule, faults are shown by the warning lamps in the instrument cluster.

Data saved in the control units can only be read and analysed with special equipment.

A qualified workshop is only able to recognise and deal with faults by using the relevant saved data. Among other things, the saved data may contain the following information:

- Data relating to the engine and the gearbox
- Speed
- Direction of travel
- Braking force
- Seat belt warning system data

The control units installed will not under any circumstances record conversations in the vehicle.

### Event data recorder

Your vehicle is **not** equipped with an event data recorder.

In an event data recorder, information about the vehicle is temporarily saved. In the event of an accident, you can therefore obtain detailed information about the course of events. On vehicles with an airbag system, accident-related data such as impact speed, seat belt status, seat positions and trigger times can be saved. The exact information saved depends on the manufacturer.

The installation of an event data recorder is subject to the agreement of the vehicle's owner. This process is governed by legislation in some countries.

### Reprogramming control units

All data for controlling components are saved in the control units. Some convenience features, such as one-touch signalling, single door unlocking and display messages can be reprogrammed using special workshop equipment. If any convenience features are reprogrammed, the information in this Owner's Manual will no longer be accurate for the features that have been changed. We recommend having the reprogramming approved.

Your Audi dealer will be able to provide you with information about possible reprogramming options.

### Event memory

There is a diagnostic connection for reading out the event memory located in the footwell on the driver's side of the vehicle. Information regarding the operation and status of the vehicle's electronic control units is stored in the event memory. The event memory should only be read out and erased by a qualified workshop.



#### WARNING

The diagnostic connection must not be used for other purposes. Incorrect use can cause malfunctions – risk of accident!

# Multi Media Interface

## Notes on traffic safety

You should only use certain infotainment system functions, e.g. enter a navigation destination, while the vehicle is stationary. Always be prepared to stop operating the infotainment system in the interest of your own safety and that of other road users.

**! WARNING**  
 Only operate the infotainment system when the traffic conditions allow you to do so safely and when you can maintain proper control of your vehicle - risk of accident!

**i Note**  
 Certain functions are not available while the vehicle is in motion.

## Introduction

The Multi Media Interface (MMI) combines different communication, navigation\* and entertainment systems in your Audi. You can operate your MMI system via the MMI control console, the multi-function steering wheel or the speech dialogue system\*.

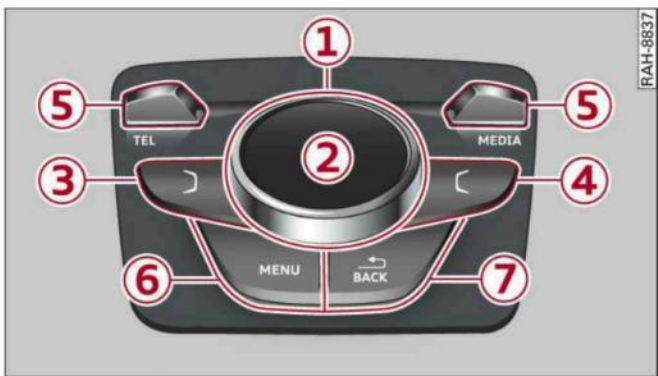

Fig. 140 MMI control console

Overview of MMI control console

|   |          |
|---|----------|
| ① Rotary pushbutton with joystick function* ..... | 153, 157 |
| ② MMI touch pad* .....                            | 155      |
| ③ Left control button .....                       | 154      |
| ④ Right control button .....                      | 154      |
| ⑤ Buttons for calling up menus directly .....     | 154      |

|                     |     |
|---------------------|-----|
| ⑥ MENU button ..... | 154 |
| ⑦ BACK button ..... | 153 |

## MMI ON/OFF button with joystick function

### How to use



Fig. 141 MMI ON/OFF button with joystick function

**Switching MMI on/off:** The MMI can be switched on/off manually.

- **To switch on manually:** Briefly press the ON/OFF button ① ⇒ Fig. 141. **Or:** Press the MENU button ⑥ ⇒ page 152, Fig. 140 or one of the buttons for calling up menus directly ⑤.
- **To switch off manually:** Press and hold the ON/OFF button ① ⇒ Fig. 141 until the MMI switches off. The MMI system will *not* be switched on automatically when the ignition is switched on if it was turned off manually the last time it was operated.

### Other functions:

- **To adjust the volume:** Turn the ON/OFF button ① ⇒ Fig. 141.
- **Mute:** Briefly press the ON/OFF button ① ⇒ Fig. 141.
- **To select the previous/next function (e.g. radio station/track):** Briefly press the ON/OFF button ① ⇒ Fig. 141 to the left ⏪ or right ⏩.
- **To rewind/fast forward (e.g. track):** Press and hold the ON/OFF button ① ⇒ Fig. 141 to the left ⏮ or right ⏭.

**! WARNING**  
 The audio system volume should be set at a level which enables you to hear external signals (such as the sirens of police and



emergency vehicles) clearly – failure to do so could result in an accident.

### **i** Note

If the engine is switched off and the vehicle battery charge level is low, the MMI system will be switched off automatically.

## Infotainment display

### Switching on/off

– **To switch on/off manually:** Press the  button  ⇒ page 10, Fig. 2.

You can operate certain functions using the MMI ON/OFF button with joystick function when the MMI is switched on but the display is switched off ⇒ page 152.

### Notes on the illustrations of the displays

The display type depends on the equipment fitted in your vehicle.

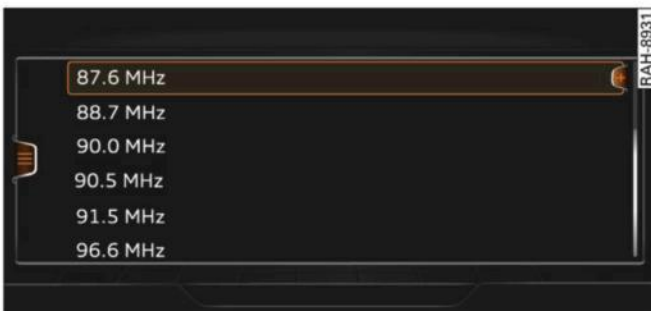

Fig. 142 Display type A

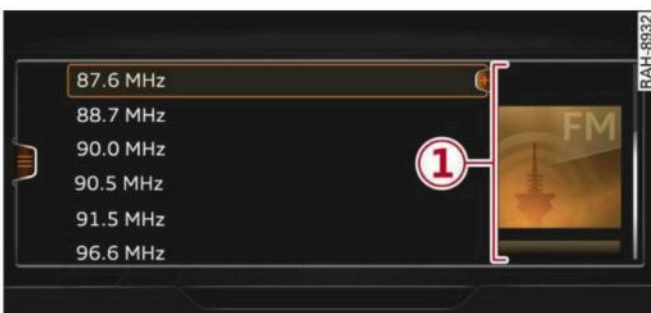



Fig. 143 Display type B

Additional content (e.g. album covers, maps) may be shown on display type B  ⇒ Fig. 143. As the other content is almost identical for both display types, the illustrations in this Owner's Manual primarily show display type A, depending on the topic.

## How to use the MMI

### Selecting and confirming a function

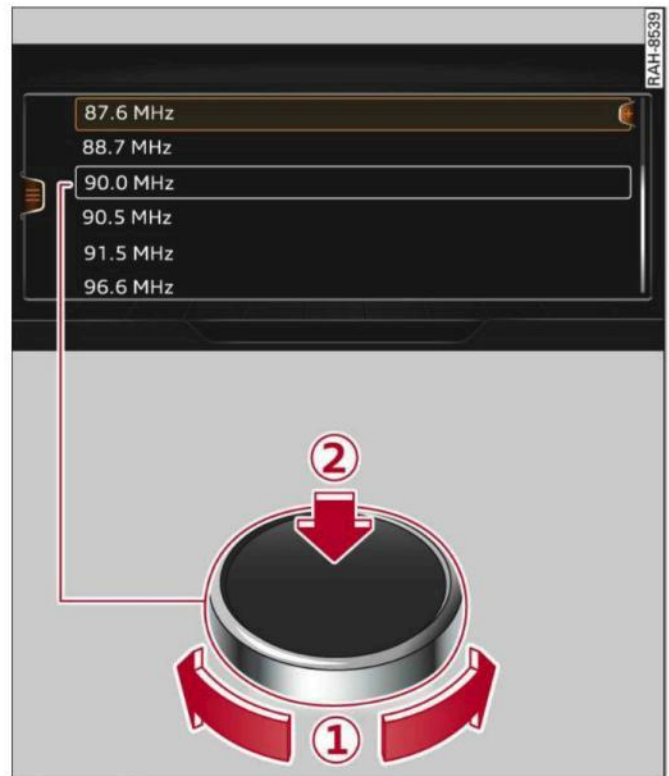



Fig. 144 How to use the rotary pushbutton

### Selecting and confirming a function in a menu/list

- ▶ **To select a function:** Turn the rotary pushbutton  ⇒ Fig. 144 to the desired function (e.g. setting a frequency).
- ▶ **To confirm the selection:** Press the rotary pushbutton  ⇒ Fig. 144.

### Returning to the previous function level

- ▶ Press the **BACK** button  ⇒ page 152, Fig. 140.

### Calling up the main menu/menu



Fig. 145 Illustration: Main menu

### Calling up the main menu

- ▶ Press the button marked **MENU** ⑥  
⇒ page 152, Fig. 140. The MMI menus (e.g. **Radio**) will be displayed ⇒ Fig. 145. You can then use the rotary pushbutton to select and confirm a function.

### Calling up a menu directly

- ▶ Press the corresponding button to call up menus directly ⑤ ⇒ page 152, Fig. 140 in the direction of the menu you require (e.g. **RADIO**). You can then use the rotary pushbutton to select and confirm a function.

### Calling up the selection/options menu with the control buttons

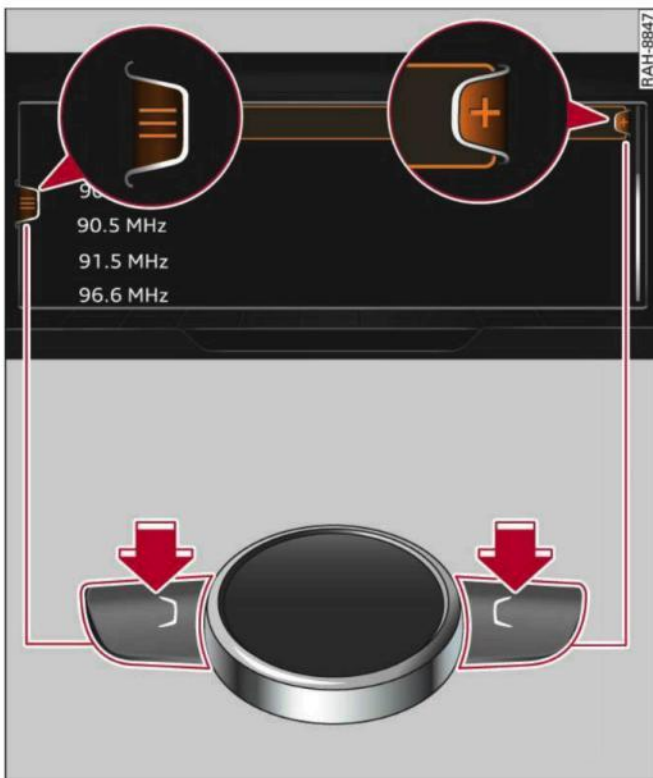

Fig. 146 Control buttons on MMI control console

**Selection menu:** You can use the selection menu to call up further functions for individual menu items (e.g. **Radio**).

Important: The symbol for the selection menu must be shown on the infotainment display ⇒ Fig. 146.

**To call up/close the selection menu:** Press the left control button ⇒ Fig. 146. You can then use the rotary pushbutton to select and confirm a function.

**Options menu:** You can use the options menu to select and confirm specific functions for individual menu items (e.g. **Radio**) and to make changes to settings.

Important: The symbol for the options menu **+** must be shown on the infotainment display ⇒ Fig. 146. You can then use the rotary pushbutton to select and confirm a function.

**To call up/close the options menu:** Press the right control button ⇒ Fig. 146. You can then use the rotary pushbutton to select and confirm a function.

### Notes on path descriptions

The path descriptions in this manual show you at a glance how to call up the menu you require along with its settings and functions.

### Example of a path description

- ▶ Select: **RADIO** button > left control button > **FM**.

### Using a path description

- ▶ Press the **RADIO** button.
- ▶ Press the left control button.
- ▶ Turn the rotary pushbutton to **FM** in the menu.
- ▶ Press the rotary pushbutton to confirm **FM**.
- ▶ The function you have selected and confirmed is now set. In this example, the **FM** waveband is selected.

## MMI touch

### MMI touch pad

Applies to: vehicles with MMI touch

You can enter data on the MMI touch pad with the help of handwriting recognition.



Fig. 147 Entering a navigation destination via the MMI touch pad

The MMI touch pad is located between the control buttons ⇒ Fig. 147.

### Entering letters, numbers and characters

Applies to: vehicles with MMI touch

The MMI touch pad enables information to be entered with the help of handwriting recognition.



Fig. 148 Display when MMI touch is active

Important: A function requiring text or number input must be active and the symbol ① ⇒ Fig. 148 must be shown on the display.

- **Basic principle:** Use your finger to write an individual letter (capital or small letters) or numbers/symbols on the MMI touch pad. If the system positively identifies a character, it will be shown on the infotainment display ① ⇒ page 155, Fig. 147 and may be confirmed acoustically. It will then be shown in the entry field.
- **To enter a space:** Move your finger from left to right across the MMI touch pad.
- **To delete a character:** Move your finger from right to left across the MMI touch pad.
- **To use the suggestion:** Press the rotary pushbutton.
- **To switch directly to the results list:** Turn the rotary pushbutton to the right.
- **To enter Cyrillic characters:** Press the right control button. Select and confirm **Switch to Cyrillic characters**.
- **To open the speller:** Select the right control button > **Open speller**. Text and numbers can be entered via the speller ⇒ page 159.

### Moving the crosshairs

Applies to: vehicles with MMI touch

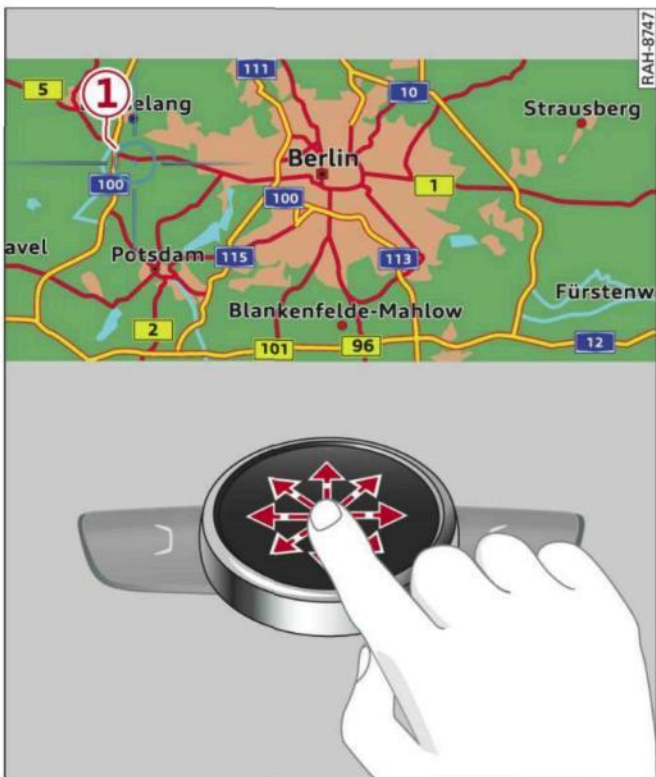

Fig. 149 Moving the crosshairs

Important: A map must be displayed  
⇒ page 219.

- **To bring up/hide the crosshairs:** Press the rotary pushbutton to bring up the crosshairs ① ⇒ Fig. 149. Or: Press the MMI touch pad. To hide the crosshairs, press the **[BACK]** button ⑦ ⇒ page 152, Fig. 140.
- **To move the crosshairs on the map:** Move your finger in the desired direction on the MMI touch pad while the crosshairs are displayed ⇒ Fig. 149.

**To move the crosshairs quickly:** Move your finger quickly in the desired direction on the MMI touch pad while the crosshairs are displayed ① ⇒ Fig. 149. The crosshairs will only stop moving again after a few seconds.

### Moving the map

Applies to: vehicles with MMI touch

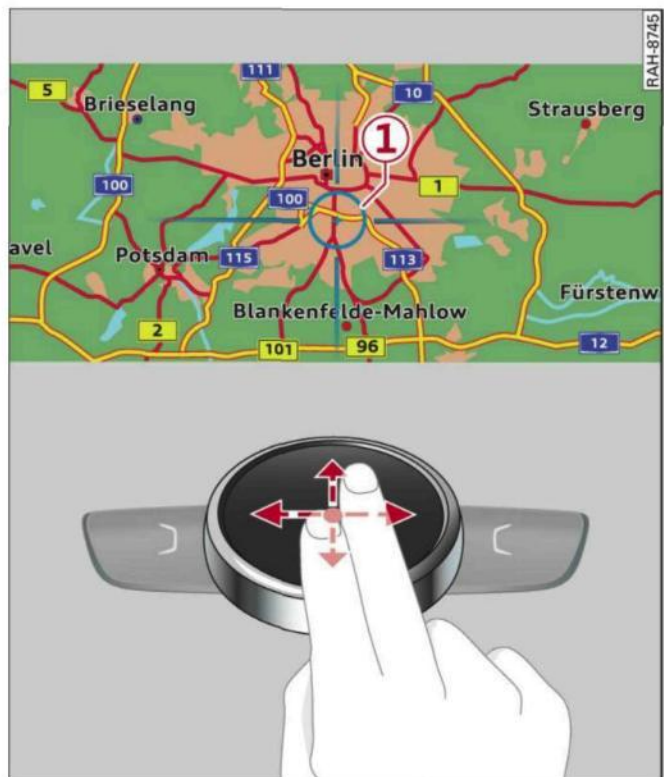

Fig. 150 Moving the map

Important: A map must be displayed  
⇒ page 219.

- **To bring up/hide the crosshairs:** Press the rotary pushbutton to bring up the crosshairs ① ⇒ Fig. 150. To hide the crosshairs, press the **[BACK]** button ⑦ ⇒ page 152, Fig. 140.
- **To move the standard map/Google Earth map:** Move two fingers in the desired direction on the MMI touch pad while the crosshairs are displayed ⇒ Fig. 150.
- **To move the map:** Move two fingers in the desired direction on the MMI touch pad while the crosshairs are displayed ⇒ Fig. 150.
- **To move the map quickly:** Move two fingers in the desired direction on the MMI touch pad quickly while the crosshairs are displayed. The map will only stop moving again after a few seconds.

### Zooming in/out on map

Applies to: vehicles with MMI touch

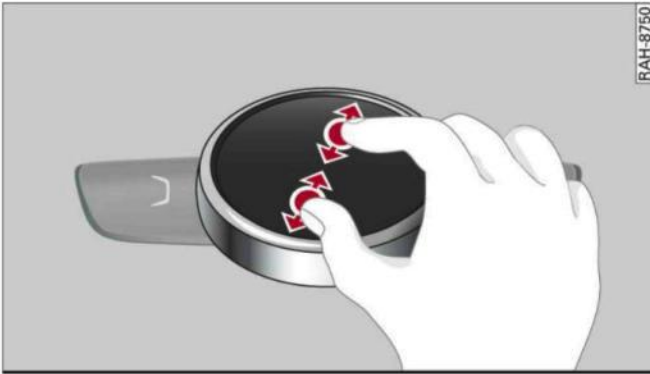

Fig. 151 Zooming in/out on the map

Important: A map must be displayed  
⇒ page 219.

- **To zoom in/out on the map:** Press the rotary pushbutton to bring up the crosshairs. Place two fingers on the MMI touch pad and move them apart/together ⇒ Fig. 151.

To hide the crosshairs, press the **BACK** button  
⑦ ⇒ page 152, Fig. 140.

### Adjusting the sound focus

Applies to: vehicles with MMI touch

Important: The Balance/fader\* option must be selected  
⇒ page 260.

- **To move the crosshairs of the sound focus:** Move your finger in the desired direction on the MMI touch pad.
- **To store the location of the crosshairs:** Press the rotary pushbutton twice. **Or:** Press the **BACK** button ⑦ ⇒ page 152, Fig. 140.

### Operating the DVD main menu

Applies to: vehicles with MMI touch

Important: A video DVD must be playing  
⇒ page 243.

- **To select a menu option:** Move your finger up/down or to the left/right on the MMI touch pad.
- **To confirm your selection:** Press the rotary pushbutton.

### Note

- You can set the volume of the MMI touch spoken cues according to your own preferences ⇒ page 262.
- Please note the direction of writing if the menu language is set to Arabic.

## Rotary pushbutton with joystick function

### Using

Applies to: vehicles with joystick function

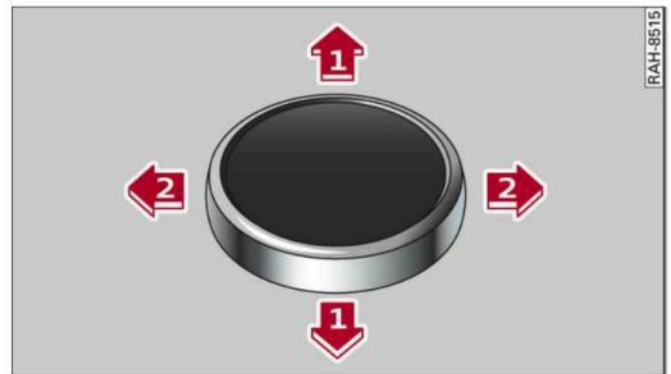

Fig. 152 How to use the rotary pushbutton with joystick function

You can push the rotary pushbutton up/down ①  
⇒ Fig. 152 or to the left/right ②.

### Calling up the entertainment drawer

Applies to: vehicles with MMI touch

**To call up the entertainment drawer:** Press the rotary pushbutton downwards to open the entertainment drawer ③ ⇒ page 161, Fig. 156. You can then select and confirm a function.

**To close the entertainment drawer:** Press the rotary pushbutton upwards to close the entertainment drawer. **Or:** Press the **BACK** button ⑦ ⇒ page 152, Fig. 140.

### Further functions

Applies to: vehicles with joystick function

#### Displaying the entry field/switching to the speller

Push the rotary pushbutton upwards ⇒ page 157, Fig. 152 to access the entry field or the beginning of a list in the central area. If the entry field ►

is already open, you can switch directly to entry via the speller by pushing the rotary pushbutton upwards again ⇒ *page 159*.

### On the map

Important: A map must be displayed  
⇒ *page 219*.

- **To display the entry field:** Push the rotary pushbutton upwards.
- **To display the route:** If route guidance is active, you can have the route displayed by pushing the rotary pushbutton upwards ⇒ *page 213, Fig. 176*.
- **To zoom in/out of the map:** Turn the rotary pushbutton to the left/right to make the map scale larger or smaller.
- **Further options for the map:** Refer to ⇒ *page 220*.

Applies to: vehicles without MMI touch with joystick function

- **To bring up/hide the crosshairs:** Press the rotary pushbutton. The crosshairs will appear on the map. To hide the crosshairs, press the **BACK** button.
- **To move the crosshairs:** With the crosshairs displayed, turn the rotary pushbutton in the direction you would like to move the crosshairs. Press and hold the rotary pushbutton until the crosshairs are at the desired position on the map.

### Adjusting the sound focus

Applies to: vehicles without MMI touch with joystick function

Important: The balance/fader option must be selected ⇒ *page 260*.

- **To adjust the sound focus using the crosshairs:** The crosshairs can be moved horizontally. Turn the rotary pushbutton to the left or right. To move the crosshairs vertically, press the rotary pushbutton. Turn the rotary pushbutton to the left or right. Press the rotary pushbutton again to save the setting.

### Operating the DVD main menu

Important: A video DVD must be playing  
⇒ *page 243*.

- **To select a menu option:** Move the rotary pushbutton with joystick function up or down, or to the left or right.
- **To confirm your selection:** Press the rotary pushbutton.

### Calling up the selection/options menu with the rotary pushbutton

Applies to: vehicles with joystick function

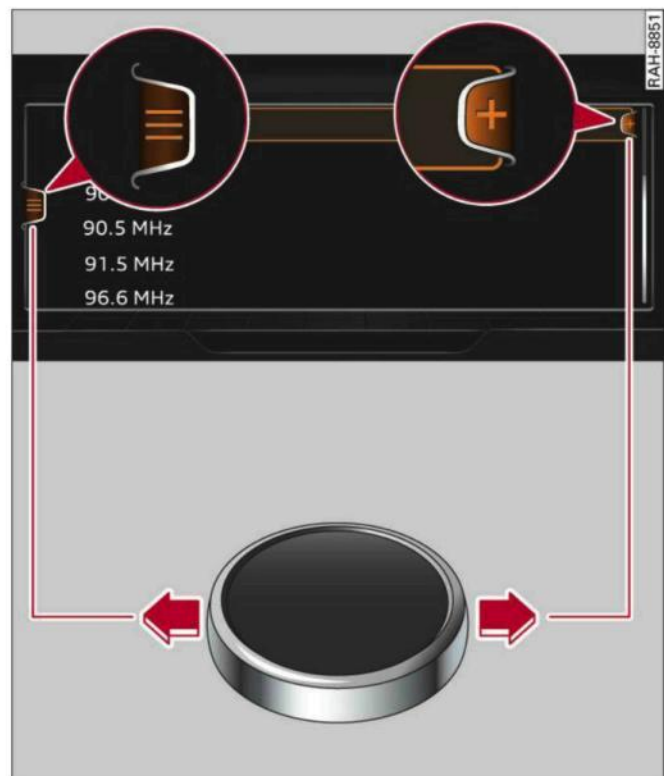

Applies to: MMI control console with rotary pushbutton and joystick function

**Fig. 153** Calling up the selection/options menu with the rotary pushbutton

Important: The symbol for the selection menu must be shown on the infotainment display  
⇒ *Fig. 153*.

**To call up/close the selection menu:** Press the rotary pushbutton to the left ⇒ *Fig. 153* to call up the selection menu. You can then use the rotary pushbutton to select and confirm a function.

Press the **BACK** button **7** ⇒ *page 152, Fig. 140* to return to the previous function.

**To call up/close the options menu:** Press the rotary pushbutton to the right ⇒ *Fig. 153* to call up the options menu. You can then use the rotary pushbutton to select and confirm a function. ▶



Press the **BACK** button (7) ⇒ page 152, Fig. 140 to return to the previous function.

## Speller for letters/numbers



Fig. 154 Illustration: Speller for letters/numbers

You can use the speller to enter letters, numbers and symbols on the MMI. This option is available while the entry field (2) is active ⇒ Fig. 154.

- **To call up/close the speller for letters/numbers:** Push the rotary pushbutton upwards/downwards while the entry field is active. **Or:** Select the right control button > **Open speller/Close speller.**
- **To enter a letter/number:** With the selection line activated, turn the rotary pushbutton (10) ⇒ Fig. 154 to select the desired letter/number. Press the rotary pushbutton to confirm the letter/number. Your entry will appear in the entry field (2). When you have entered all characters, select and confirm button (1) to switch to the results list. **Or:** Push the rotary pushbutton downwards.
- **To enter diacritics (e.g. â, ç, ñ, ö)\*:** With the selection line activated, turn the rotary pushbutton to select a letter (10) ⇒ Fig. 154. To open the corresponding set of diacritics, press and hold the rotary pushbutton. Turn the rotary pushbutton to select a diacritic while in the character selection line (10) ⇒ Fig. 154. Press the rotary pushbutton to apply the diacritic. To close the set of diacritics without selecting a character, press and hold the rotary pushbutton again. **Or:** Select and confirm [äöü] (7) ⇒ Fig. 154. Select and confirm a diacritic.

- **To delete a character:** Use the rotary pushbutton to turn the pointer to [X] (12) ⇒ Fig. 154, and then press the rotary pushbutton. To delete all characters in the entry field, select [X] and press and hold the rotary pushbutton until all characters have been deleted.
- **To enter a special character:** Select and confirm [!&?] (6) ⇒ Fig. 154, [äöü] (7) or [123] (8). Use the speller for numbers to select and confirm the special character desired (such as a hyphen or full stop).
- **Input help:** In some cases (such as in the navigation system\*), the system will suggest a word\* to complete your entry while you are still making it (11) ⇒ Fig. 154. You can confirm the word by pushing the rotary pushbutton upwards.
- **Results list:** In some cases (such as in the directory), the system will switch to the results list (3) ⇒ Fig. 154 automatically. Select and confirm a suggestion from the list.

Requirement: The entry field (2) ⇒ Fig. 154 must be active.

- **To switch between the speller and the MMI touch pad\*:** The handwriting recognition feature is automatically activated for the MMI touch pad\*, which means you can simply start writing.

### Overview of the symbols in the speller

The symbols of the speller for letters/numbers are explained in the following table:

|   | Symbol / marking    | Description   |
|---|---------------------|---|
| ① | LIST or ▾           | To switch to the results list.  |
| ② | Entry field         | The current entry is displayed.<br><i>Menu language Arabic:</i> A vertical line on the left/right side of the cursor indicates where the next character will be inserted. |
| ③ | Results list        | A list of suggestions for the letters already entered is displayed.   |
| ④ | ▲                   | To switch from lower case to upper case letters and vice versa.<br><i>Menu language Arabic:</i> To show additional Arabic characters.                                     |
| ⑤ | ⌂                   | To open further speller options, e.g. <b>Close speller</b> , <b>Clear entry field</b> or <b>Switch to Cyrillic characters</b>   |
| ⑥ | !&?                 | Punctuation and special characters  |
| ⑦ | äōů                 | To display diacritics (e.g. â, ç, ñ, ö) or the Cyrillic alphabet.<br><i>Menu language Arabic:</i> To switch between Arabic and Latin characters.                          |
| ⑧ | 123/ABC             | To switch the speller from letters to numbers and vice versa  |
| ⑨ | ␣                   | To enter a space in the entry field.  |
| ⑩ | Character selection | The character selected will be highlighted.   |
| ⑪ | ▲                   | The suggested word* can be accepted by pushing the rotary pushbutton upwards.   |
| ⑫ | ⌫                   | To delete the character to the left of the cursor.<br><i>Menu language Arabic:</i> Note the direction of writing.   |

**Note**  
Diacritics are not available for every letter.

### Search function

Applies to: vehicles with search function

You can enter search terms in any order using the search function.



Fig. 155 Illustration: Search function in the telephone menu

The search function is available in the **Car\***, **Radio\***, **Media\***, **Telephone\***, **Navigation\*** and **Audi connect\*** menus.

#### Calling up the search function

- ▶ Select: **MENU** button > *desired menu item* (e.g. **Telephone**).
- ▶ Turn the rotary pushbutton to the left until the entry field ① ⇒ Fig. 155 for the **search function** is displayed. **Or:** Push the rotary pushbutton upwards to call up the entry field ①.

The handwriting recognition feature is automatically activated for the MMI touch pad\*, which means you can simply start writing.

#### Searching for an entry

- ▶ Enter one or more search terms in the entry field in any order. The individual search terms must be separated by spaces.

The system may make suggestions to complete your entry\* ③ ⇒ Fig. 155 depending on what you have entered. Further entries containing the search terms entered will be displayed in the list of results ②.

If the desired term is not yet displayed, continue entering letters until it appears.

The first few letters of the search terms will often be sufficient to bring up a list of results. In the **Telephone\*** menu, for example, write the initials of the contact you are looking for, separating them with a space.

**Confirming an autocomplete suggestion**

Important: An autocomplete suggestion\* ③ ⇒ Fig. 155 must be displayed.

► **When using MMI touch\*:** Press the rotary pushbutton.

**Using an entry from the results list**

Important: At least one entry must be displayed in the results list ② ⇒ Fig. 155.

► **When using MMI touch\*:** Turn the rotary pushbutton to the right. Select an entry from the list and confirm it.

► **When using the speller:** Select and confirm LIST ① ⇒ page 159, Fig. 154. **Or:** Push the rotary pushbutton downwards. Select an entry from the list and confirm it.

**Menus and symbols**

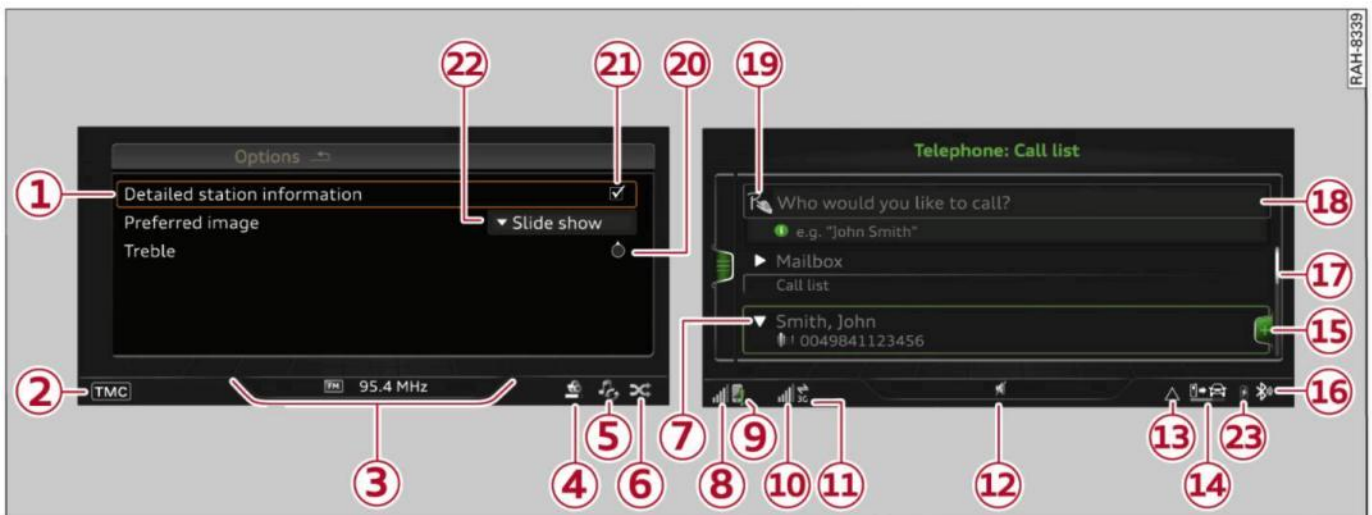

Fig. 156 Illustration: Menus and symbols

| Symbol / marking          | Description   |
|---------------------------|---|
| ① Selected option         | Selected function   |
| ② TMC                     | Reception of TMC/TMCpro/online traffic information ⇒ page 225   |
| ③ Entertainment drawer    | Information on the media source currently selected or an event (e.g. a call) is displayed. Depending on the vehicle's equipment, you may be able to operate functions (e.g. tuning to a radio station, answering a call) via the open entertainment drawer ⇒ page 157 |
| ④ Jukebox* import process | Copying audio/video files to the jukebox ⇒ page 236   |
| ⑤ Repeat track            | The track currently playing will be repeated ⇒ page 247   |
| ⑥ Random playback         | All tracks in the playlist will be played in random order ⇒ page 247, <b>Random playback</b>  |
| ⑦ Arrow                   | Information can be called up by pressing the rotary pushbutton when text is highlighted   |

|   | Symbol / marking                          | Description   |
|---|---|---|
| ⑧ | Signal strength bars for telephone        | Reception strength for the telephone  |
| ⑨ | Exclamation mark on the telephone         | Indicates missed calls  |
| ⑩ | Signal strength bars for data connection* | Reception strength of the active connection, or<br><b>PIN</b> : Enter the SIM PIN code<br><b>PUK</b> : Enter the PUK code<br><b>SIM</b> : Insert the SIM card |
| ⑪ | 2G/3G/LTE*                                | Network coverage of the active connection ⇒ <i>page 203</i><br><b>2G</b> : GSM network<br><b>3G</b> : UMTS network<br><b>LTE*</b> : LTE network               |
| ⑫ | Mute function                             | Audio source muted ⇒ <i>page 261</i>  |
| ⑬ | Roaming                                   | Connected mobile phone/SIM card inserted in SIM card reader* or embedded SIM card has left its mobile network   |
| ⑭ | Import procedure                          | Import/update of contacts in the directory/call list  |
| ⑮ | Options menu*                             | Select and confirm specific functions for individual menu items and make changes to settings.   |
| ⑯ | Bluetooth*                                | Bluetooth device connected ⇒ <i>page 237</i> /⇒ <i>page 173</i>   |
| ⑰ | Scrolling bar                             | Signifies a long list.<br>You can move within lists by turning the rotary pushbutton  |
| ⑱ | Entry field                               | Entries that can be changed using the speller for letters/numbers<br>⇒ <i>page 159</i> or the MMI touch pad* ⇒ <i>page 155</i>                                |
| ⑲ | MMI touch*                                | Can be used via the MMI touch pad   |
| ⑳ | Rotary control                            | Settings for the selected function can be made by turning the rotary pushbutton   |
| ㉑ | Checkbox                                  | You can switch certain functions on <input checked="" type="checkbox"/> or off <input type="checkbox"/> by pressing the rotary pushbutton.                    |
| ㉒ | Selection list                            | Settings for the selected function that can be called up by pressing the rotary pushbutton  |
| ㉓ | Battery*                                  | Battery charge level of the connected mobile phone during wireless charging   |

## GLOBAL COMMANDS

- Telephone
- Audi connect
- Navigation
- Directory
- Radio
- Media
- Sound
- Help
- Help Speech Dialogue System
- Help Telephone
- Help Audi connect
- Help Navigation
- Help Map
- Help Radio
- Help Media

- Favourites
- Call (XY)
- Enter number
- Redial
- Read new text message
- Drive me to (XY)
- Enter address
- Stop route guidance
- Map
- Line (XY)
- Next page / previous page
- Cancel
- Online destinations
- No, I meant (XY)
- Correction



## TELEPHONE

- Enter number
  - Delete number / Correction
- Directory
- Call (XY)
  - business / private / land line / mobile

- Call list
- Redial
- Call mailbox
- Enter PIN / delete PIN
- Telephone favourites



## NAVIGATION

- Navigate to (XY)
- Start / stop route guidance
- Directory
- Last destinations
- Navigation favourites
- Drive home
- Enter address
- Enter country / town / street
- Exclude route / Exclude route for (XY) km / m

- Exclude next route section / Exclude next street
- Manual / Automatic traffic avoidance
- Route list
- Calculate alternative routes
- Online destinations
- Special destinations



## MAP

- Map
- Day map / Night map
- 2D driving position map / 2D north position map / 3D map / Destination map / Overview map

## AUDI CONNECT

- Audi connect
- Travel information / Parking information
- Fuel prices
- Weather

- Flight information / Train information
- City events
- Online news
- Twitter

## RADIO

- Radio favourites
- FM and DAB
- FM / DAB / AM
- Station (XY) / Frequency (XY)
- Ensemble (XY)
- Traffic programme on / off



## MEDIA

- Jukebox
- CD / DVD
- SD card 1 / SD card 2
- Audi music interface / iPod / USB / Bluetooth / Wi-Fi / Medium (XY)
- Media favourites / Artists / Albums / Genres / Tracks / Playlists / Videos
- Folder up
- Random playback on / off



Fig. 157 Overview of commands





# Speech dialogue system

## How to use the speech dialogue system

Applies to: vehicles with speech dialogue system

*You can operate many infotainment functions conveniently by voice.*

**Important:** The ignition and the MMI system must be switched on ⇒ *page 152*, you must not be talking on the phone, and the parking aid must not be active.

- ▶ **To switch on:** Briefly press the  button ② ⇒ *page 17, Fig. 12* / ③ ⇒ *page 18, Fig. 14* on the multi-function steering wheel and give a spoken command after the **beep** signal.
- ▶ **To switch off:** Press and hold the  button for several seconds. **Or:** Press the  button.
- ▶ **To pause:** Say the command **Pause**. To end the pause, press the  button.
- ▶ **To make a correction:** Say the command **Correction**.

### Input help

The system guides you through the input routine with cues and messages.

- **Input help messages on screen:** After the speech dialogue system is switched on, a selection of possible commands will be shown. The command display can be switched on or off as required. Select:  button > **Settings** > left control button > **MMI settings** > **Speech dialogue system**.
- **Spoken input help cues:** To have the system play the commands currently possible, switch on the speech dialogue system and say **Help**.

### How to help the system understand you

Speak clearly in a normal volume. Speak louder if you are driving fast.

Speak in a normal tone without long pauses.

Close doors, windows and sun roof\* to reduce background noise. Make sure that passengers are not talking when you say a command.

Keep the air outlets of the air distribution system pointed away from the microphone, which is fit-

ted in the vicinity of the front interior lights in the headliner.

The system should only be operated by the driver, since the handsfree microphone is directed towards the driver.

### Other settings

Refer to ⇒ *page 262*.

#### **WARNING**

- Please direct your full attention to the road at all times! As the driver, you have full responsibility for the safety of the vehicle and other road users. For this reason, you should only use the functions in a manner that allows you to maintain control of the vehicle in all situations - accident risk!
- The speech dialogue system must not be used in cases of emergency, since the voice changes in stressful situations. This could result in a failed or delayed telephone connection. Always dial emergency numbers manually!

#### **Note**

- The dialogue is paused when an incoming telephone call is received; you can continue the dialogue by ignoring the call. If you answer the call, the dialogue will be cancelled.
- No navigation cues\* or traffic announcements are played when a dialogue is running.
- You can select an entry from a list both via the speech dialogue system and using the rotary pushbutton.
- The speech dialogue system does not support commands in Arabic, Norwegian or Hungarian.

## Notes on the overviews of commands

Applies to: vehicles with speech dialogue system

The following overviews show you the commands that you can give to operate the MMI via the speech dialogue system. ▶

Alternative commands are separated by the symbol “/”; for example you can say: **Telephone** / (or) **Navigation** / (or) **Radio**.

Commands that belong together and should be spoken as a sequence are marked with the symbol “>”; for example you can say: **Enter address** > (and subsequently) **Enter country**.

As a rule, only the main commands are displayed. However, the system may also recognise some synonyms. For example, for **business address** you can also say **work address**, **office address**, **the office** or **at work**.

## Commands

### Global commands

Applies to: vehicles with speech dialogue system

You can give global commands any time, irrespective of the menu currently selected.

| Function                                     | Say:   |
|--|--|
| Calling up the menu                          | <b>Telephone / Directory / Navigation / Radio / Media / Audi connect* / Car / Tone</b>   |
| Having the system play the possible commands | <b>Help / Help Speech dialogue system / Help Telephone / Help Navigation / Help Map / Help Radio / Help Media / Help Audi connect*</b>                                 |
| Telephone functions                          | <b>Call (XY), e.g. Call John Smith / Enter number / Redial / Directory / Read new text message / Read new e-mail / Dictate text message</b>                            |
| Navigation functions*                        | <b>Drive me to (XY) or Navigate to (XY), e.g. Navigate to John Smith / Enter address / Stop route guidance / Map / Online destinations* / Online destination (XY)*</b> |
| Calling up the favourites                    | <b>Favourites</b> > <i>follow the directions given by the system</i>   |
| Selecting an entry from a list               | <b>Line (XY)</b>   |
| Scrolling through a list                     | <b>Next page / Previous page</b>   |
| Correcting a command                         | <b>Correction</b>  |
| Switching off the speech dialogue system     | <b>Cancel</b>  |

### Telephone

Applies to: vehicles with speech dialogue system and telephone

Important: A mobile phone must be connected to the MMI ⇒ *page 173*, and the **Telephone** menu must be open ⇒ *table on page 165*.

You may be able to say the following commands depending on the menu item selected:

| Function  | Say:   |
|---|--|
| Calling a contact from the directory            | <b>Call (XY), e.g. Call John Smith</b>   |
| Dialling a specific number stored for a contact | <b>Call (XY) business / private / land line / mobile, e.g. Call John Smith private</b> |

| Function   | Say:  |
|--|---|
| Dialling a phone number when an address card is open | <b>Call / Call business number / Call private number / Call land line / Call business mobile</b>                        |
| Calling a contact from the favourites list           | <b>Telephone favourites &gt; desired contact when requested &gt; Dial</b>   |
| Displaying the call list                             | <b>Call list</b>  |
| Calling the last number dialled                      | <b>Redial</b>   |
| Dialling a telephone number                          | <b>Enter number &gt; enter phone number in blocks of individual digits when requested, e.g. 07441 234 567 &gt; Dial</b> |
| Correcting an entered phone number                   | <b>Correction / Delete number</b>   |
| Displaying contact information                       | <b>Directory &gt; desired contact when requested, e.g. John Smith</b>   |
| Listening to voice mail messages                     | <b>Call mailbox</b>   |
| Entering the SIM PIN code                            | <b>Enter PIN &gt; enter PIN in individual digits when requested &gt; Store</b>  |
| Correcting an entered PIN                            | <b>Correction / Delete PIN</b>  |
| Correcting an entry                                  | <b>No, I meant (XY)</b>   |
| Closing the full list of commands                    | <b>Close</b>  |

### Note

– If you have a mobile phone that transmits first names and surnames separately, you can select directory contacts both by entering the full name (“first name, surname” or “surname, first name”) and by saying only the first name or surname.

– Please note that commands can only be spoken for the main telephone\*  
⇒ *page 173*.

– For more information on which mobile phones are supported, please go online (e.g. [www.audi.com/bluetooth](http://www.audi.com/bluetooth)) or contact an Audi dealer.

## Audi connect (infotainment)

Applies to: vehicles with speech dialogue system and Audi connect (infotainment)

Important: The requirements for Audi connect (infotainment) must be met ⇒ *page 191*.

| Function  | Say:  |
|---|---|
| Calling up an Audi connect infotainment service     | <b>Audi connect &gt; follow the directions given by the system</b>  |
| Audi connect infotainment services                  | <b>Weather / Online news / Fuel prices / Parking information / Travel information / Twitter / Online traffic information / City events / Flight information / Train information</b> |
| Search areas for Audi connect infotainment services | <b>In vicinity of destination / In immediate vicinity / In new town</b>   |
| Correcting an entry                                 | <b>No, I meant (XY)</b>   |



**i Note**

Please always note the information in the chapter ⇒ *page 204, General notes on Audi connect (infotainment)*.

**Messages - Audi connect (infotainment)**

Applies to: vehicles with speech dialogue system and Audi connect (infotainment)

**Important**

A SIM card with a messaging and data option must be inserted in the SIM card reader\* ⇒ *page 192*.

Alternatively, a SIM card with a data option must be inserted in the SIM card reader and a mobile

phone with activated MAP (Message Access Profile) must be connected to the MMI ⇒ *page 173*.

The declaration of consent must have been accepted ⇒ *page 183*.

| Function                           | Say:   |
|------------------------------------|--|
| Text message dictation             | <b>Dictate text message / Dictate text message to (XY)</b> > follow the directions given by the system |
| E-mail dictation                   | <b>Dictate e-mail / Dictate e-mail to (XY)</b> > follow the directions given by the system             |
| Commands for text editing          | <b>Read / Continue / Delete / Re-record / Replace with (XY) / Add recipient / Send</b>                 |
| Having a new message read out      | <b>Read new text message / Read new e-mail</b>   |
| Having a message read out          | <b>Read text message / Read e-mail</b>   |
| Replying to an opened text message | <b>Reply</b>   |
| Forwarding an opened text message  | <b>Forward</b> > <b>Add recipient / Insert template / Send</b>   |
| Correcting an entry                | <b>No, I meant (XY)</b>  |

**i Note**

- The “Text message dictation” and “E-mail dictation” services are not available in all languages and markets. Your Audi dealer will be able to provide you with more detailed information.
- For more information on which mobile phones are supported, please go online

(e.g. [www.audi.com/bluetooth](http://www.audi.com/bluetooth)) or contact an Audi dealer.  
 – Please always note the information in the chapter ⇒ *page 204, General notes on Audi connect (infotainment)*.

**Navigation**

Applies to: vehicles with speech dialogue system and navigation system

Important: The **Navigation** menu must have been opened ⇒ *table on page 165*.

On vehicles with navigation system (SD card): The SD card containing the navigation data must be inserted in the SD card reader ⇒ *page 235*.

You may be able to say the following commands to enter a destination, depending on the menu item selected: ▶

| Function  | Say:  |
|---|---|
| Calling up a list of recent navigation destinations                             | <b>Last destinations</b>  |
| Calling up the favourites   | <b>Navigation favourites</b>  |
| Calling up your home address  | <b>Home address</b> or <b>Drive home</b>  |
| Entering an address with assistance from the system                             | <b>Enter address</b> > <i>follow the directions given by the system</i>   |
| Individual commands for entering a destination                                  | <b>Enter country / Enter town / Enter post code / Enter street / Enter house number</b>   |
| Making corrections while entering a destination                                 | <b>Correction</b>   |
| Navigating to a contact   | <b>Drive me to (XY)</b> or <b>Navigate to (XY)</b> , e.g. <b>Drive me to John Smith</b>   |
| Navigating to a specific address stored for a contact                           | <b>Navigate to (XY) business / private</b> , e.g. "Navigate to John Smith private"  |
| Navigating to favourites  | <b>Navigation favourites</b> > <b>Line (XY) / line content</b> > <i>start route guidance when requested</i>                               |
| Starting route guidance when an address card is open                            | <b>Navigate / Navigate to private address / Navigate to business address</b>  |
| Entering a new destination/stopover while route guidance is active              | <b>Enter address</b> > <i>desired address when requested</i> > <i>confirm new destination/stopover when requested</i>                     |
| Starting route guidance after entering a destination                            | <b>Start route guidance</b>   |
| Cancelling the active route guidance  | <b>Stop route guidance</b>  |
| Calculating alternative routes  | <b>Calculate alternative routes</b>   |
| Entering a special destination with search area with assistance from the system | <b>Special destination</b> > <b>Change search area</b> > <i>enter desired category or subcategory when requested</i> , e.g. "Restaurant"  |
| Categories for entering special destinations                                    | <b>Audi Service / Railway station / Airport / Hotel / Hospital / Parking space / Service area / Restaurant / Filling station etc.</b>     |
| Search areas for entering special destinations                                  | <b>In immediate vicinity / In vicinity of route / In vicinity of destination / In vicinity of stopover / In new town / In new country</b> |
| Entering an online destination*   | <b>Online destination (XY)</b> , e.g. "Online destination Palace Hotel"   |
| Correcting an entry   | <b>No, I meant (XY)</b>   |
| Closing the full list of commands   | <b>Close</b>  |

Important: The **Navigation** or **Map** menu must be open. You can say the following commands to make additional navigation settings: ►

| Function  | Say:  |
|---|---|
| General map options   | <b>Map / Day map / Night map / Change map colours automatically</b>   |
| Map type  | <b>2D driving position map / 2D north position map / 3D map / Destination map / Overview map / Standard map* / Traffic map* / Google Earth map*</b> |
| Displaying the route list   | <b>Route list</b>   |
| Displaying remaining distance/time while route guidance is active | <b>Destination info</b>   |
| Highest speed query   | <b>How fast can I go here?</b>  |
| Setting the navigation cues during active route guidance          | <b>Voice guidance on / Voice guidance off / Voice guidance compact / Voice guidance complete / Voice guidance traffic</b>                           |
| Dynamic traffic avoidance   | <b>Manual traffic avoidance / Automatic traffic avoidance / Switch off traffic avoidance</b>  |
| Excluding the next section of the route                           | <b>Exclude route</b>  |
| Excluding a certain section of the route                          | <b>Exclude route for (XY) metres/kilometres/yards/miles / Exclude next street / Exclude next section of route</b>                                   |

### Note

– Depending on the selected menu language and the country you are in, you may have to spell destinations to enter them for route guidance.

– Please always note the information in the chapter ⇒ page 204, *General notes on Audi connect (infotainment)*.

## Radio

Applies to: vehicles with speech dialogue system

Important: The **Radio** menu must have already been opened.

You may be able to say the following commands depending on the waveband selected:

| Function   | Say:  |
|--|---|
| Selecting a waveband   | <b>FM and DAB* / DAB* / FM / AM</b>                         |
| Tuning to a station from the station list                                  | <b>Station (XY) / Ensemble (XY)<sup>a)</sup></b>            |
| Selecting a station from the favourites                                    | <b>Radio favourites &gt; Line (XY)</b>                      |
| Setting the frequency  | <b>Frequency (XY)</b>                                       |
| Receiving traffic news stations and switching traffic announcements on/off | <b>Traffic announcements on / Traffic announcements off</b> |
| Correcting an entry  | <b>No, I meant (XY)</b>                                     |
| Closing the full list of commands  | <b>Close</b>  |

<sup>a)</sup> Applies to the DAB\* waveband

## Media

Applies to: vehicles with speech dialogue system

Important: You must be in the **Media** menu.

You may be able to say the following commands depending on the medium active:

| Function   | Say:   |
|--|--|
| Selecting a source directly  | <b>Jukebox*</b> / <b>CD</b> / <b>DVD</b> / <b>SD card 1</b> / <b>SD card 2</b> / <b>Audi music interface*</b> / <b>iPhone*</b> / <b>USB*</b> / <b>Bluetooth*</b> / <b>Wi-Fi*</b> / <b>Medium (XY)</b> , e.g. "Rachel's player" |
| Selecting audio/video* files from the jukebox*                     | <b>Media favourites</b> / <b>Artists</b> / <b>Albums</b> / <b>Genres</b> / <b>Tracks</b> / <b>Playlists</b> / <b>Videos</b>  |
| Selecting audio files from an iPod (source: Audi music interface*) | <b>Artists</b> / <b>Albums</b> / <b>Genres</b> / <b>Tracks</b> / <b>Playlists</b> / <b>Composers</b> / <b>Podcasts</b> / <b>Audiobooks</b>   |
| Navigating in a structure of folders/list                          | <b>Folder up</b> / <b>Line (XY)</b>  |
| Selecting random playback  | <b>Switch on random playback</b> / <b>Switch off random playback</b>   |
| Correcting an entry  | <b>No, I meant (XY)</b>  |
| Closing the full list of commands                                  | <b>Close</b>   |

## Natural commands

Applies to: vehicles with speech dialogue system and natural commands

The following overview shows a selection of commands that enable you to speak more naturally with your vehicle.

**TELEPHONE**

- I want to talk to John Smith.
- Who did I call lately?
- Who called me last?
- Call the last number.



**NAVIGATION**

- I would like to go to (XY).
- How much longer to go?
- Show me the traffic on the map.
- How far can the fuel get us?
- Nearest restaurant.
- I'm hungry. Let's eat.



**RADIO**

- Please select BBC.



**MEDIA**

- Play my favourite music.
- What artists have I got?



Fig. 158 Natural commands in the speech dialogue system

### Note

The natural commands are not available for all languages.

## External speech dialogue system

Applies to: vehicles with speech dialogue system and external speech dialogue system

Important:



The ignition and the MMI system must be switched on.

You must not be speaking on the phone.

The parking aid and the Audi speech dialogue system must not be active.

A mobile phone must be connected to the MMI system via the **Handsfree** profile ⇒ *page 173*.

The mobile phone connected must feature a speech dialogue function that can be controlled externally.

- ▶ **To switch on:** Press *and hold* the  button on the multi-function steering wheel\* and give a spoken command after the external speech dialogue system has been activated.
- ▶ **To continue/restart a dialogue:** After a dialogue has been ended, the system remains active for a short period during which you can start a new external dialogue at any time. If necessary, press the  button and say a new command. **Or:** Select and confirm **Continue** on the MMI control console.
- ▶ **To switch off:** Press and hold the  button for several seconds. **Or:** Select and confirm **Cancel** on the MMI control console.

### Note

- No navigation cues\* or traffic announcements\* are played when a dialogue is active.
- This function depends on the mobile phone you are using. For further information regarding your mobile phone, contact your mobile network service provider or refer to the operating instructions for your mobile phone.
- AUDI AG only enables you to access your mobile phone's speech dialogue system and accepts no responsibility for the content and commands of the external speech dialogue system.

# Telephone

## Introduction

Applies to: vehicles with telephone

You have different options for making calls in your vehicle via the MMI; this depends on your vehicle's equipment and the features of your mobile phone.

### Handsfree operation

After connecting your mobile phone to the MMI system via Bluetooth, you can operate the handsfree system and the telephone functions conveniently via the MMI. Your phone calls will be made via the antenna of your mobile phone.

With the Audi phone box\*, you can use the vehicle's external aerial to make calls. The use of the external aerial reduces radiation in the vehicle and also ensures better reception quality ⇒ *page 177*.

### Car phone\*<sup>1)</sup>

As part of Audi connect (infotainment)\*, the Audi phone box\* includes a car telephone function which can be used via a separate mini SIM card in the SIM card reader\* or an rSAP-enabled mobile phone. With the car telephone function, you can use the vehicle's external aerial to make calls. The use of the external aerial reduces radiation in the vehicle and also ensures better reception quality ⇒ *page 177*.

Once a connection has been established successfully, you can also change the profiles at a later time. Refer to ⇒ *page 257, Connection manager*.

### WARNING

- According to health organisations, mobile phones may interfere with the function of pacemakers. A minimum distance of 20 cm should be kept between the mobile phone aerial and the pacemaker.

- Do not carry a mobile phone in your breast pocket directly over the pacemaker when the phone is switched on.
- If you suspect interference, switch the mobile phone off immediately.
- The speech dialogue system\* ⇒ *page 164* must not be used in cases of emergency, since the voice changes in stressful situations. This could result in a failed or delayed telephone connection. Always dial emergency numbers manually!
- Switch off your mobile phones in all areas where there may be a risk of explosion. Remember that these areas may not always be adequately marked. Such places are filling stations, fuel and chemical storage facilities or transport vehicles and other places where fumes, chemicals (e.g. from leaking propane or fuel vapours in vehicles or buildings) or large quantities of dust particles (e.g. from flour, wood or metal) could accumulate in the air. This warning also applies to all other places where you would normally switch off your engine.
- Today's driving conditions require the full attention of drivers. Please always note the information in the chapter ⇒ *page 152, Notes on traffic safety*.

### CAUTION

Please always observe the information ⇒  in *Wi-Fi hotspot on page 202*.

### Note

- The maximum range of the Bluetooth connection is limited to the interior of the vehicle. The connection can be susceptible to interference from other electronic devices.
- For information regarding which Bluetooth connections and functions your mobile phone supports, contact your mobile network service provider or consult the mobile device database at [www.audi.com/bluetooth](http://www.audi.com/bluetooth).

<sup>1)</sup> Not available in all markets. On vehicles with Audi connect (infotainment)\* and Audi phone box\*

- We recommend using the vehicle's Wi-Fi hotspot\* when the car phone\* is in use so that your mobile phone's apps retain access to the Internet.
- When the car phone function\* is active, Audi connect (infotainment)\* is only available using your own SIM card ⇒ *page 191*.

## Setting up

### Connecting a mobile phone via Bluetooth

Applies to: vehicles with telephone

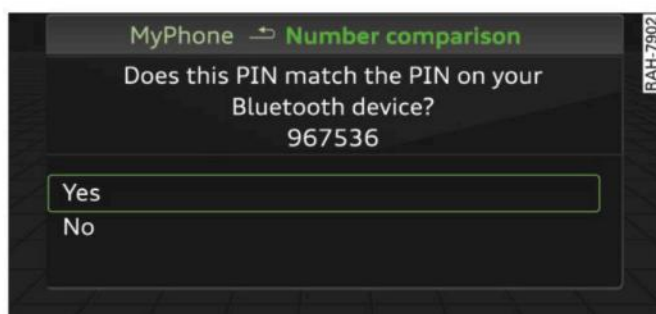

Fig. 159 PIN display for entry on mobile phone

#### Important

The vehicle must be stationary, and the ignition must be switched on.

The Bluetooth function and the discoverability option of the MMI system ⇒ *page 258* and the mobile phone must be activated.

The mobile phone you would like to connect must not be connected to any other Bluetooth device.

The MMI must not be connected to a mobile phone.

A mini SIM card must not be inserted in the SIM card reader\*.

#### Connecting a mobile phone

- ▶ Select: **MENU** button > **Telephone** > **Connect mobile phone** > **Find new devices** > **Continue**. The available Bluetooth devices will be shown on the infotainment display. **Or:** Select: **MENU** button > **Settings** > left control button > **MMI settings** > **Connection manager** ⇒ *page 257*.

- ▶ Select and confirm the desired mobile phone from the list of Bluetooth devices shown.
- ▶ The MMI will generate a PIN for the connection ⇒ *Fig. 159*.
- ▶ Select and confirm **Yes**.
- ▶ Enter the PIN to establish a connection on your mobile phone. **Or:** If the PIN is already being displayed on your mobile phone, confirm it on the phone and on the MMI. You have about 30 seconds to enter the PIN.
- ▶ You may need to enter the PIN for your SIM card in the MMI<sup>1)</sup>.
- ▶ Please note any additional system queries on your mobile phone, e.g. whether the phone should connect automatically in the future. On some mobile phones, you may also need to download the directory and allow access to your messages separately.

#### After connecting successfully

After the connection has been established successfully, you will be shown a short message containing information on the profiles used to establish the connection. You can also change the profiles afterwards. Select: **MENU** button > **Settings** > left control button > **MMI settings** > **Connection manager** ⇒ *page 257*.

In addition, the contacts on the mobile phone are automatically loaded into the directory of the MMI. This may take several minutes, depending on how many contacts are stored on the mobile phone.

Applies to: vehicles with Audi connect (infotainment)

- ▶ If you have successfully connected your mobile phone via the Bluetooth remote SIM Access Profile, you can use either the embedded SIM card <sup>2)</sup> or your own SIM card to use Audi connect infotainment services.
- ▶ Confirm the system query with either **Yes** or **No**. For more information on Audi connect (infotainment), please refer to ⇒ *page 191*.
- ▶ **Yes:** All data connections for all Audi connect infotainment services will be established by a ▶

<sup>1)</sup> Not available in all markets. Applies to mobile phones with Bluetooth remote SIM Access Profile on vehicles with Audi connect (infotainment)\* and Audi phone box\*.

<sup>2)</sup> SIM card installed in vehicle at factory.

mobile network provider via the embedded SIM card<sup>1)</sup> ⇒ *page 191*. Your mobile phone will be connected via **Handsfree** only ⇒ *page 172*, and you will not be able to use the car telephone function\* ⇒ *page 172*.

- ▶ **No: All** data connections for all Audi connect infotainment services will use your own SIM card. All connections via the embedded SIM card<sup>1)</sup> will be disconnected, and you will be able to use the car telephone function\* ⇒ *page 172*.

You can now use Audi connect infotainment services.

Applies to: vehicles with Audi connect (infotainment)

- ▶ You can configure your vehicle's mobile Wi-Fi hotspot\*<sup>2)</sup> and the Audi connect infotainment services\* immediately after connecting an rSAP-enabled mobile phone ⇒ *page 191*. **Or:** Select **TEL** button > right control button > **Connection manager** > right control button > **Wi-Fi settings**.

Using the function **Store as default telephone** in the **Connection manager**, you can store one of your connected mobile phones as the default phone ⇒ *page 258*.

### CAUTION

Please always observe the information ⇒  *in Wi-Fi hotspot on page 202*.

### Note

- You can adjust further settings for connected mobile phones using the **connection manager** ⇒ *page 257*.
- You can also search for the MMI system via the Bluetooth device search function on your mobile phone.
- Bluetooth devices only have to be bonded once. Any devices that have already been bonded to the MMI system are connected automatically when the Bluetooth function

is switched on, the devices are within range of the car and the ignition is on. The mobile phone last connected is given priority.

- You will need to authorise the MMI connection on your mobile phone to enable automatic connection.
- Please note any system queries on your mobile phone, e.g. whether the phone should connect automatically in the future. On some mobile phones, you may also need to download the directory and allow access to your text messages separately.
- You receive the SIM PIN code from your mobile network service provider together with the SIM card. If you enter the SIM PIN code incorrectly three times<sup>3)</sup> in a row, the SIM card will be blocked. A PUK (personal unblocking key) must be entered in order to reactivate the SIM card.
- The Bluetooth connection between the system and the mobile phone is automatically terminated when you leave the car. Depending on the mobile phone, telephone calls may be transferred automatically from the MMI to your mobile phone so that you can continue talking.
- For further information regarding your mobile phone, contact your mobile network service provider or refer to the operating instructions for your mobile phone. For information on using a phone in your car, please go online (e.g. [www.audi.com/bluetooth](http://www.audi.com/bluetooth)) or ask an Audi dealer.

1) SIM card installed in vehicle at factory.

2) Not available in all markets.

3) The number of possible attempts depends on the SIM card.



## Operating two phones via the MMI

Applies to: vehicles with Audi phone box

You can connect two mobile phones to the MMI system using the Audi phone box (e.g. your business mobile as the primary phone and your personal mobile as an additional phone). You can then be reached inside the vehicle on both mobile phones.

The first mobile phone that you connect is shown as the primary phone on the MMI system. The second mobile phone is connected as an additional phone.

The system will always display the phone book on the primary phone while it is connected. To use the phone book on the additional phone, you have to swap the primary phone and additional phone ⇒ *page 175*.

### Connecting a mobile phone as the primary phone

Connect your mobile phone to the MMI system via Bluetooth. The first mobile phone that you connect is shown as the **primary phone** on the MMI system.

Refer to ⇒ *page 173, Connecting a mobile phone via Bluetooth*.

### Connecting a mobile phone as an additional phone

Important: A mobile phone must be connected to the MMI system as the primary phone. **Or:** Your own mini SIM card<sup>1)</sup> for making and receiving calls must be inserted in the SIM card reader\*.

Select: **[MENU]** button > **Telephone** > right control button > **Connect additional phone**.

Refer to ⇒ *page 173, Connecting a mobile phone via Bluetooth*.

For example, you have connected your business mobile to the MMI system as the primary phone and your personal mobile as the additional phone. To call a contact stored in your personal

phone book, you now have to swap the primary phone with the additional phone because the system always displays the phone book from the primary phone.

### Inserting your own mini SIM card in the SIM card reader\*

Important: The MMI must not be connected to a mobile phone.

Refer to ⇒ *page 176, Making and receiving calls using your own mini SIM card*.

If you want to use your mini SIM card in the SIM card reader\* as an additional phone, please refer to ⇒ *page 189*.

### Swapping the primary phone and additional phone

Important: A primary phone and additional phone must be connected.

To swap the primary phone with the additional phone, select: **[MENU]** button > **Telephone** > right control button > **Switch primary & additional phone**.

#### Note

- Please note that the system only ever displays the directory on the primary phone.
- Please note that, when your mini SIM card is inserted in the SIM card reader\*, any mobile phones for making and receiving calls which are already connected to the MMI via Bluetooth will be disconnected.
- You can see in the **connection manager** ⇒ *page 257* whether your mobile phone is connected as a primary phone or an additional phone. **Or:** The device name of the primary phone connected to the system (e.g. MyPhone) is displayed in the **Telephone** menu.
- If the primary phone is not connected to the MMI automatically when the ignition is switched on, e.g. because it is out of range of the vehicle or because the Bluetooth function is switched off, a phone which was

<sup>1)</sup> Not available in all markets. On vehicles with Audi connect (infotainment)\* and Audi phone box\*

previously connected as an additional phone will be connected automatically as the primary phone.

- You can send and receive messages on both the primary phone and additional phone ⇒ *page 178, Fig. 162*. You do not have to swap the primary phone and additional phone to do so.
- Using the function **Store as default telephone** in the **Connection manager**, you can store one of your connected mobile phones as the default phone ⇒ *page 258*.

### Making and receiving calls using your own mini SIM card

Applies to: vehicles with Audi connect (infotainment) and Audi phone box



Fig. 160 Mini SIM card (actual size)

The SIM card reader is located in the glove box 23 ⇒ *page 10, Fig. 2*.

With this telephone option<sup>1)</sup>, you can be reached on the telephone number of your own SIM card in the SIM card reader. Depending on the type of mini SIM card, this may be the same number as for your current mobile phone contract (twin/

Multi SIM card) or another number from a different mobile phone contract.

### Important

The vehicle must be stationary, the ignition must be switched on and the **Telephone** menu must have been called up.

### Using your own mini SIM card

- ▶ The missing corner of the mini SIM card should be at the front left. Slide the mini SIM card into the slot in the SIM card reader ⇒ *Fig. 160* until you feel it engage.
- ▶ If requested, enter the PIN code for your mini SIM card in the MMI.
- ▶ Select and confirm **OK**.
- ▶ To allow the MMI to connect automatically in the future, select and confirm **Yes**.
- ▶ Select and confirm either **Telephone installed in vehicle (SIM card)** or **Personal mobile phone (Bluetooth)**.

**Telephone installed in vehicle (SIM card):** The external car aerial is used. The SIM card is used for phone calls and Audi connect (infotainment)\*.

**Personal mobile phone (Bluetooth):** The external car aerial is only used in conjunction with the Audi phone box. The mini SIM card in the card reader is only used for Audi connect (infotainment)\*.

You can set whether you would also like the system to establish a data connection for the Audi connect infotainment services\* ⇒ *page 193*.

Please observe the notes on using Audi connect (infotainment) ⇒ *page 191*.

### After connecting successfully

After connecting successfully, either one or two symbols (depending on the connection type) will appear in the status line of the infotainment display to indicate the signal strength 8/10 ⇒ *page 161, Fig. 156*.

You can go back and change whether calls are made using the mini SIM card in the SIM card reader or your mobile phone by selecting the ▶

<sup>1)</sup> Not available in all markets.

**MENU** button > **Settings** > left control button > **MMI settings** > **Connection manager**  
⇒ page 257.

In addition, the contacts on the mobile phone are automatically loaded into the directory of the MMI. This may take several minutes, depending on how many contacts are stored on the mobile phone.

### Removing a mini SIM card

- ▶ Briefly press the mini SIM card. The card will then eject from the slot. Remove the mini SIM card.

#### **!** CAUTION

- To avoid damaging the SIM card reader, only use mini SIM cards (25 mm x 15 mm) ⇒ Fig. 160. Please contact your service provider for more information on mini SIM cards.
- Should you have inserted a different SIM card size in the SIM card reader, do not under any circumstances attempt to remove it yourself as this may damage the SIM card reader. Please contact a qualified workshop.
- If you use SIM card adapters, the vibrations caused by the movement of the vehicle may cause the SIM card to become detached from the adapter - risk of damage to the SIM card reader.

#### **i** Note

If your mobile phone does not support the remote SIM Access Profile (e.g. iPhone), you can use the contacts from your mobile phone by connecting the mobile phone to the system via the **Directory/contacts** profile  
⇒ page 258.

## Using the Audi phone box

Applies to: vehicles with Audi phone box

You can use the Audi phone box to charge your mobile phone's battery. You can use the vehicle's external aerial to make calls, which reduces radiation in the vehicle and also ensures better reception quality.\*



Fig. 161 Audi phone box with connections

The Audi phone box is located in the centre console beneath the armrest **33** ⇒ page 10, Fig. 2

Important: A mobile phone must be connected via Bluetooth ⇒ page 173.

The following options are available:

- **To establish a connection with the external car aerial<sup>1)</sup>**: Place your mobile phone onto the middle of the telephone symbol in the Audi phone box ⇒ Fig. 161 with the phone's display facing upwards. When doing so, make sure that there are no objects between the Audi phone box and the mobile phone.
- **To charge a mobile phone wirelessly<sup>2)</sup>**: Place your Qi compatible<sup>2)</sup> mobile phone onto the middle of the  $\Phi$  symbol in the Audi phone box ⇒ Fig. 161 with the phone's display facing upwards. The mobile phone will be charged.
- **To charge a mobile phone via a USB adapter:** Connect your mobile phone to the USB charging socket **1** ⇒ Fig. 161 using a USB adapter cable.

You can charge your mobile phone using special USB adapters ⇒ page 240, Fig. 196. ▶

1) Not available in all markets. Additional car telephone function only with Audi connect (infotainment)\*.

2) The Qi standard enables you to charge your mobile phone wirelessly.

**! WARNING**

- Loose objects can be flung around in the passenger compartment in the event of sudden driving or braking manoeuvres. This could result in serious injuries and also cause you to lose control of the vehicle. Always keep the centre armrest closed when driving.
- The mobile phone may become hot while charging wirelessly. Consider the temperature of your mobile phone when removing it. Take the mobile phone out of the Audi phone box carefully.

**i Note**

- The Audi phone box is not available in all countries. Your Audi dealer will be able to provide you with more detailed information.
- If the mobile phone is placed in the Audi phone box in a bag or a protective case, this may interfere with the connection to the external aerial\*.
- Any metal objects in the Audi phone box will prevent the mobile phone from charging wirelessly or being used to make calls via the external aerial\*.
- The charging time and the temperature vary depending on the mobile phone being used.
- The ignition must be switched on to charge a mobile phone in the Audi phone box.
- To avoid malfunctions, ensure that the mobile phone is correctly placed inside the Audi phone box.
- The maximum charging capacity is 5 W.
- An enhanced transmission quality cannot be guaranteed if more than one mobile phone is placed inside.\*
- Audi recommends the use of Audi Genuine Accessories. Audi has tested these products for suitability, reliability and safety.
- USB adapters are available from Audi dealers or specialist retailers.
- When you charge your mobile phone wirelessly, the charging procedure may be interrupted if you place your remote control key in the Audi phone box together with the mobile phone.

## Using the telephone

### Calling up the telephone

Applies to: vehicles with telephone



Fig. 162 Example: Telephone functions in the selection menu



Fig. 163 Example: Further telephone functions in the selection menu

**Important:** A mobile phone must be connected to the MMI ⇒ *page 173*, or your own mini SIM card must be inserted in the SIM card reader\* ⇒ *page 176*.

► Select: **MENU** button > **Telephone** > left control button.

The following telephone functions are available ⇒ *Fig. 162/⇒ Fig. 163*:

|   |     |
|---|-----|
| ① Call list . . . . .   | 179 |
| ② Favourites . . . . .  | 181 |
| ③ Directory . . . . .   | 185 |
| ④ Enter number . . . . .  | 179 |
| ⑤ Text message (SIM card)*/Text message (MyPhone)*/Text message (additional phone)* . . . . . | 182 |
| ⑥ E-mail (MyPhone)*/E-mail (additional phone)* . . . . .                                      | 183 |

Your mobile phone's device name is displayed in the **Telephone** menu, e.g. Text message (MyPhone) ⇒ *Fig. 163*.

## Dialling a number

Applies to: vehicles with telephone

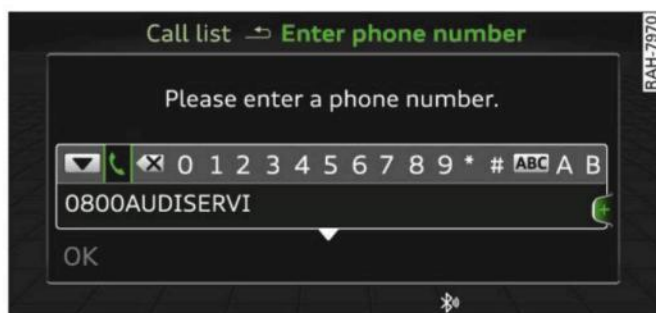

Fig. 164 Speller for numbers



Fig. 165 Dialling a telephone number from the call list

- ▶ Select: **[MENU]** button > **Telephone** > left control button.

### Call list

Important: The call list must contain a telephone number.

Turn the rotary pushbutton to show the call list.

Select and confirm the desired telephone number in the call list.

Symbols in the call list ⇒ Fig. 165:

- ① Missed calls
- ② Numbers dialled
- ③ Received calls

Select: *a contact from the list* > right control button.

- **Call:** To call the selected contact.
- **Connect additional phone\*/Switch primary & additional phone\*:** Refer to ⇒ page 175.
- **Edit number before making call:** To edit a telephone number before making a call. Select and confirm **OK** to use the changes. **Or:** Press the left control button to go back without making the changes.
- **Send text message:** To send the selected contact a text message.

- **Delete call list:** Select and confirm if you wish to **Delete this entry** or **Delete all entries**.
- **Store as favourite:** To store the selected contact as a favourite.
- **Show contact details:** Refer to ⇒ page 186.
- **Connection manager:** Refer to ⇒ page 257.
- **Bluetooth settings:** Refer to ⇒ page 258.
- **Online settings:** Refer to ⇒ page 258.
- **Wi-Fi settings:** Refer to ⇒ page 201, *Wi-Fi hotspot*.
- **Telephone settings:** Refer to ⇒ page 187.

### Favourites

Important: A telephone number or a contact must have been added as a favourite ⇒ page 181.

Select and confirm a favourite in the favourites list.

### Directory

Important: You must have stored a contact on your mobile phone.

Select and confirm a telephone number in the directory ⇒ page 185.

### Enter number

- **To enter a telephone number using numbers:** Enter a telephone number using the speller for numbers ⇒ Fig. 164.
- **To enter a telephone number using letters:** Select and confirm **[ABC]** using the speller for numbers. Enter a series of letters, e.g. *AUDI-SERVICE* using the speller for letters.
- **To dial a telephone number:** Select and confirm **[PHONE]**. **Or:** Push the rotary pushbutton downwards. Select and confirm **OK**.
- **To delete letters/numbers individually:** Select and confirm **[X]**.
- **To delete all the numbers/letters you have entered at once:** With the selection line activated, turn the rotary pushbutton to **[X]** and press and hold the rotary pushbutton. **Or:** Select the right control button > **Clear entry field**.

### Answering/ending a call

Applies to: vehicles with telephone

- **To answer a call:** Select and confirm **Answer**.
- **To decline a call:** Select and confirm **Ignore**.
- **To mute an active call:** Select and confirm **Mute**.
- **To end a call/cancel the dialling process:** Select and confirm **End call**.

**Caller information:** Depending on whether the caller is stored in the directory and whether the telephone number is transmitted with the call, the caller's *name*, his/her *telephone number* or **Unknown** will appear on the infotainment display. A photo of the caller may also be shown if one has been assigned to the contact in your mobile phone and transmitted to the MMI. You can find out if your mobile phone supports this function by asking your mobile network provider, consulting your mobile phone's operating manual or visiting [www.audi.com/bluetooth](http://www.audi.com/bluetooth).

#### Note

- Media playback or the radio is muted automatically during a call.
- A symbol is displayed in the status line of the infotainment display if there are any missed calls  ⇒ *page 161, Fig. 156*.

### During a telephone call

Applies to: vehicles with telephone

**Important:** A call must be in progress.

- ▶ **End call:** You can end the call.
- ▶ **Send tone sequence:** You can enter **DTMF** tones ("touch-tones") directly using the speller for numbers. These are then sent to the person you are speaking to.
- ▶ **Further call options:** Press the right control button.

The following options may be available during a call depending on the mobile phone being used and the type of connection:

- **To answer a further call:** If you are already talking on the phone when someone else calls, select **Answer** to place the current call on hold

- and to answer the incoming call. If you select **Ignore**, the incoming call will be declined.
- **To answer a further call when you are talking on the phone and have another call on hold:** Select **Replace**. The current call will be replaced by the incoming call.
- **To mute an incoming call:** Select and confirm **Mute**.
- **Further call:** Select **Find contact > Call list/Directory/Favourites > an entry from the list**.

**Switch microphone off:** If you select and confirm this option, the caller will no longer be able to hear you; you will still be able to hear the caller. Select and confirm **Switch microphone on** to switch the microphone back on.

**Hold/Resume:** You can put a call on hold and retrieve it later from the hold queue. Select and confirm a call to resume it.

**Transfer call to mobile phone\*:** Select and confirm **Transfer call to mobile phone** to transfer your current call from the MMI to your mobile phone.

**Retrieve call\*:** Important: A call must be in progress. Select and confirm **Retrieve call** to transfer the current call back to the MMI from your mobile phone.

**Switch:** You can switch between two phone calls (one of them will be on hold at any given time). Select **End call** to end whichever call is active. The call on hold will remain in the hold queue and can be continued by pressing the right control button > **Resume**.

**Conference:** Up to five callers and one caller on hold can take part in a conference (depending on the mobile network service provider).

- **To add participants:** Select the left control button > **Call list/Directory/Favourites > an entry in the list**.
- Select the right control button:
- **Hold:** To put all existing conference participants on hold.
- **Resume:** To resume the conference with all participants.

- **Remove conference participant:** You can remove a participant from the conference. The call with this participant will be ended.
- **Merge to conference:** The contact you have called can be added to the conference.

**Connection manager:** Refer to ⇒ *page 257*.

**Telephone settings:** Refer to ⇒ *page 187*.

### Note

- If you are using the **Handsfree** profile, the option *Call waiting* must be activated on your mobile phone for you to be alerted to incoming calls during a conversation.
- For further information, contact your mobile network service provider or refer to the operating instructions for your mobile phone.
- The Bluetooth connection between the system and the mobile phone is automatically terminated when you leave the car. Depending on the mobile phone, telephone calls may be transferred automatically from the MMI to your mobile phone so that you can continue talking.
- The display for the incoming call may remain visible for several seconds after the call is answered or ignored; this depends on the type of mobile phone you are using.

## Dialling the emergency number

Applies to: vehicles with telephone

- ▶ Select: **[MENU]** button > **Telephone** > left control button > **Enter number** > emergency number (e.g. 112) > **OK**.

### WARNING

- Since your telephone operates via radio waves, a connection cannot be guaranteed under all circumstances. Do not rely solely on your telephone when a vital communication (e.g. medical emergency) is involved.
- Always follow the directions of the emergency operators when making an emergency call and do not end the call before you are requested to do so.

### Note

Emergency numbers are not the same for all countries. Please make sure that you know the emergency number for the country you are in.

## Favourites

Applies to: vehicles with telephone

*In addition to the mailbox number, you can store up to 50 contacts in the list of favourites, in any order.*

- ▶ Select: **[MENU]** button > **Telephone** > left control button.

### Storing an existing telephone number as a favourite

- Select and confirm **Call list/Directory**.
- Select a contact/a telephone number from the list.
- Select: right control button > **Store as favourite**.
- Enter a name for the favourite or accept the suggestion.
- Select and confirm **Store**.

### Renaming a stored favourite

- Select: **Favourites** > *a favourite from the list*.
- Select: right control button > **Rename favourite**.

### Moving a stored favourite

- Select: **Favourites** > *a favourite from the list*.
- Select: right control button > **Move favourite**.
- Select and confirm the position of the favourite selected.

### Deleting a stored favourite

- Select: **Favourites** > *a favourite from the list*.
- Select: right control button > **Delete favourite** > **Delete this favourite** or **Delete all favourites**.

# Messages

### Text messages

Applies to: vehicles with car telephone function or mobile phones with Bluetooth Message Access Profile

*Depending on your mobile phone and your mobile phone contract, you may be able to send and receive text messages via the MMI. You can also use the speech dialogue system\* to dictate text messages.*

### Important

Your own mini SIM card with a messaging option must be inserted in the control console's SIM card reader\* ⇒ *page 176, Fig. 160.*

**Or:** A mobile phone with Bluetooth MAP (Message Access Profile) must be connected to the MMI ⇒ *page 173.*

► Select: **TEL** button > left control button > **Text message (SIM card)\*/Text message (My-Phone)/Text message (additional phone)\*.**

### Write new text message

Select and confirm **Write new text message.**

- **To use a template:** Select and confirm the template you require from the list.
- **To enter your own text\*:** Select and confirm **Do not use template.** Enter a text using the MMI touch pad\* or the speller for letters/numbers.
- Enter one or more recipients.
- Select and confirm **Send.**

### Dictate text message<sup>1)</sup>

Refer to ⇒ *page 167, Messages - Audi connect (infotainment).*

### Inbox

All the text messages you have received are displayed.

### Sent

All the text messages you have sent are displayed.

### Outbox

All the text messages to be sent are displayed.

### Drafts

All the text messages which have been stored but not yet sent are displayed.

### Note

- Please note that, depending on your SIM card (e.g. if you are using a Multi SIM card), you may need to activate the function for sending and receiving text messages. For further information, contact your mobile network service provider or refer to the operating instructions for your mobile phone.
- For more information on which mobile phones are supported, please go online (e.g. [www.audi.com/bluetooth](http://www.audi.com/bluetooth)) or contact an Audi dealer.
- In order to send text messages via the MMI, you will require a mobile phone with the Message Access Profile which also supports sending messages.

### Message options

Applies to: vehicles with car telephone function or mobile phones with Bluetooth Message Access Profile

► Select: **TEL** button > left control button > **Text message (SIM card)/Text message (My-Phone)/Text message (additional phone)\* > Inbox/Sent/Outbox > right control button.**

The following options may be available depending on which menu you have selected:

### Storing a text message as a template

There are already ten text message templates stored on the MMI. You can store up to ten additional templates.

- Create a text message.
- Select and confirm **Store as template.**

### Continue with last text message

You can continue with the text message you last edited. ►

<sup>1)</sup> Only available with Audi connect (infotainment).



**Reply\***

You can reply to a text message you have selected in the **Inbox**.

**Forward**

You can forward a text message you have selected to another recipient.

**Resend\***

You can re-send a text message you have selected.

**Delete this text message\***

You can delete a text message you have selected.

**Read<sup>1)</sup>**

You can have the MMI read an opened text message to you.

**Delete text messages from SIM**

A crossed-out envelope symbol is displayed in the status line of the infotainment display if the SIM card memory is full. You can still send text messages but will not be able to receive any new ones. Select **Delete sent text messages** to delete all sent text messages from the SIM card. Select **Delete read text messages** to delete all read text messages from the SIM card.

**Text message settings\***

Activate **Text message notifications** to have a notification displayed when a new text message is received. An envelope symbol ☒ is displayed in the status line of the infotainment display if there are any new text messages.

The number of your mobile network service provider's **Text message centre** is displayed. If no number has been stored, you can enter the number of the text message centre. For more information, contact your service provider.

**Text msg dict. declaration of consent<sup>2)</sup>**: Agreement that spoken data are forwarded to the service provider via AUDI AG.

**Connection manager**

Refer to ⇒ *page 257*.

**Wi-Fi settings**

Refer to ⇒ *page 201*.

**Telephone settings**

Refer to ⇒ *page 187*.

**Note**

Messages deleted using the MMI are also automatically deleted on the mobile phone.

**E-mail\***

Applies to: mobile phones with Bluetooth Message Access Profile

*Depending on your mobile phone, you may be able to send and receive e-mails via the MMI. You can also use the speech dialogue system\* to dictate e-mails.*

Important: A mobile phone with Bluetooth MAP (Message Access Profile) must be connected to the MMI ⇒ *page 173*. Please refer to the operating instructions for your mobile phone to find out whether it supports this function.

► Select: **MENU** button > **Telephone** > left control button > **E-mail (MyPhone)/E-mail (additional phone)\***.

**Write new e-mail**

Select and confirm **Write new e-mail**.

- **To use a template:** Select and confirm *the template you require from the list*.
- **To enter your own text\*:** Select and confirm **Do not use template**. Enter a text using the MMI touch pad\* or the speller for letters/numbers.
- Enter one or more recipients.
- Select and confirm **Send**.

**Dictate e-mail<sup>2)</sup>**

Refer to ⇒ *page 167, Messages - Audi connect (infotainment)*. ►

<sup>1)</sup> Not available in all languages.

<sup>2)</sup> Only available with Audi connect (infotainment).

### Inbox

All the e-mails you have received are displayed.

### Sent

All the e-mails you have sent are displayed.

### Outbox

All the e-mails to be sent are displayed.

### Drafts

All the e-mails which have been stored but not yet sent are displayed.

#### CAUTION

Please always observe the information  in *Wi-Fi hotspot on page 202*.

#### Note

- For more information on which mobile phones are supported, please go online (e.g. [www.audi.com/bluetooth](http://www.audi.com/bluetooth)) or contact an Audi dealer.
- Please connect your mobile phone to the vehicle's Wi-Fi hotspot\* so that the e-mail app on your mobile phone retains access to the Internet. This helps to ensure that e-mails can be sent and received. If you cannot receive e-mails despite being successfully connected, please contact your e-mail service provider or your mobile network provider.

### Message options

Applies to: mobile phones with Bluetooth Message Access Profile

- ▶ Select: **MENU** button > **Telephone** > left control button > **E-mail (MyPhone)/E-mail (additional phone)\*** > **Inbox/Sent/Outbox** > right control button.

The following options may be available depending on which menu you have selected:

#### Storing an e-mail as a template

There are already ten e-mail templates stored on the MMI. You can store up to ten additional templates.

- Create an e-mail.
- Select and confirm **Store as template**.

#### Continue with last edited e-mail

You can continue with the e-mail you last edited.

#### Reply\*

You can reply to an e-mail you have selected in the **Inbox**.

#### Reply to all\*

You can reply to all the recipients of an e-mail you have selected in the **Inbox**.

#### Forward

You can forward an e-mail you have selected to another recipient.

#### Delete this message\*

You can delete an e-mail you have selected.

#### Read<sup>1)</sup>

You can have the MMI read an opened e-mail to you.

#### E-mail settings\*

Activate **E-mail notifications** to have a notification displayed when a new e-mail is received. An envelope symbol  is displayed in the status line of the infotainment display if there are any new e-mails.

#### Connection manager

Refer to  *page 257*.

#### Wi-Fi settings

Refer to  *page 201*.

#### Telephone settings

Refer to  *page 187*.

#### Note

Messages deleted using the MMI are also automatically deleted on the mobile phone connected.

<sup>1)</sup> Not available in all languages.

## Listening to voicemail messages

Applies to: vehicles with telephone

▶ Select: **[MENU]** button > **Telephone** > left control button. Select and confirm **Call list/Directory/Favourites** > **Mailbox**.

– **To enter the mailbox number:** Enter the number desired. Select and confirm **OK**.

– **To dial the mailbox number:** Select and confirm **Mailbox**.

### **i** Note

- This service must be set up and activated by your mobile network service provider before you can use it. For more information, contact your service provider.
- The mailbox number depends on your service provider.

## Directory

### Calling up the directory

Applies to: vehicles with telephone

*After a mobile phone has been connected successfully, the contacts from the mobile phone are automatically imported into the directory of the MMI system.*



Fig. 166 Directory

Important: You must have stored a contact on your mobile phone.

▶ Select: **[MENU]** button > **Telephone** > left control button > **Directory**.

– **To call a contact:** Select and confirm a contact in the directory. The telephone numbers for the contact you have selected will appear. Select and confirm a phone number to start the call.

– **To use the search function:** Refer to ⇒ *page 160*.

The contacts are displayed in alphabetical order; they can be sorted by first name/surname ⇒ *page 189*, **Sort order**.

You can connect several different mobile phones to the MMI system, or use different mini SIM cards in the SIM card reader\*, allowing you to manage up to four private directories.

You can open the directory via the **Telephone** menu and via the **Navigation\*** menu.

### **i** Note

- For more information on the search function, please refer to ⇒ *page 160*.
- Please pay attention to any synchronisation queries on your mobile phone. You must confirm any synchronisation queries from the directory before the contacts can be loaded from your mobile phone into the MMI directory.
- Which contacts are displayed on the MMI depends on the mobile phone you are using. For more information on which mobile phones are supported, please go online (e.g. [www.audi.com/bluetooth](http://www.audi.com/bluetooth)) or contact an Audi dealer.
- The system will always display the directory of the mobile phone currently connected.
- In certain cases, contacts from a mobile phone may not be transmitted in alphabetical order. If there are too many entries, contacts with certain initial letters may not be displayed on the MMI system.
- If your own mini SIM card is inserted in the SIM card reader\* ⇒ *page 176*, the SIM card entries and the contacts in the local MMI memory are displayed.
- The contacts in the local MMI memory are visible anytime and are therefore not protected against access by other users.

## Using contacts from another mobile phone

Applies to: vehicles with Audi connect (infotainment) and Audi phone box

If your own mini SIM card is inserted in the SIM card reader and is used for telephone calls, you can access the directory on another mobile phone.

Important: A mini SIM card must be inserted in the SIM card reader.

► Refer to ⇨ page 258, *Directory*.

### Note

- When the MMI system has downloaded the directory from the mobile phone, the contacts from the SIM card will no longer be shown in the MMI directory.
- When you switch the ignition on again after switching it off and leaving the car, the MMI system will load the mobile phone's directory if the phone is within range and Bluetooth is activated both on the phone and on the MMI system. If this is not the case, the MMI system will show the contacts from the mini SIM card in the SIM card reader.

## Searching for a contact

Applies to: vehicles with telephone

- Select: **MENU** button > **Telephone** > left control button > **Directory**.
- To limit the search, enter the initials of the contact you are looking for individually in the entry field, separating them with a space. Enter additional letters if necessary.
- Select and confirm a contact in the directory. The telephone numbers for the contact you have selected will appear.
- Select and confirm a phone number to start the call.

### Note

- You can scroll rapidly through long lists by turning the rotary pushbutton quickly. The

scrolling speed depends on the number of entries in the list.

- For more information on the search function, please refer to ⇨ page 160.

## Show contact details\*

Applies to: vehicles with telephone

You may be able to have contact details displayed, depending on the equipment in your vehicle.

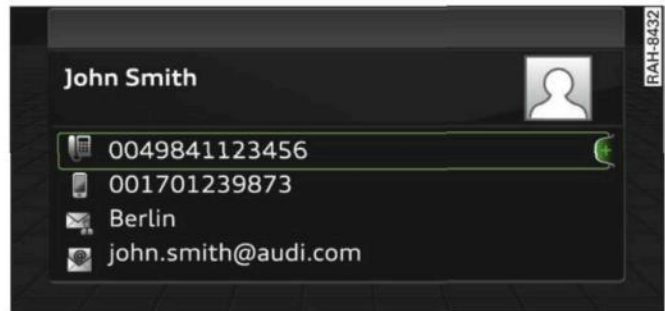

Fig. 167 Show contact details

- Select: **MENU** button > **Telephone** > left control button.
- Select and confirm **Directory** > a contact from the directory.
- Select: right control button > **Show contact details**.
- **Call**: Select and confirm the desired telephone number.
- **Navigation**: To start navigating, select and confirm the desired address. Select and confirm **Start route guidance**.

Press the right control button to call up further options for the contact details.

### Add navigation destination

To start navigating, select and confirm the desired address. Select and confirm **Start route guidance**.

### Read contact<sup>1)</sup>

The MMI system automatically creates a name tag for each contact in the directory, which you can have the system read to you. ►

<sup>1)</sup> Not available in all languages.

## Store as favourite

Refer to ⇒ *page 181, Favourites.*

## Send text message\*

You can send the selected contact a text message ⇒ *page 182.*

## Delete contact

You can delete a contact you have selected.

### Note

You can only edit/delete the contacts in the local MMI memory.

## Importing/exporting contacts

Applies to: vehicles with telephone

*You can import or export contacts in the vCard format (.vcf) into or from the directory.*

Important: An SD card must be inserted in one of the SD card readers \* ⇒ *page 235*, a USB mass storage device must be connected to the Audi music interface\* ⇒ *page 240*, or the requirements for Audi connect infotainment services\* must be fulfilled ⇒ *page 191*.

- ▶ Select: **[MENU]** button > **Telephone** > left control button > **Directory**.
- ▶ Select: right control button > **Directory settings**.
- **To import contacts from a storage device:** Select and confirm **Import contacts** > **SD card 1/SD card 2** or **USB device 1/USB device 2** > *desired contacts* > **Start import**.
- **To export contacts to a storage device:** Select and confirm **Export contacts** > **SD card 1/SD card 2** or **USB device 1/USB device 2** > *desired contacts* > **Start export**.
- **To select all contacts at once for import/export:** Select and confirm **Import contacts/Export contacts** > **SD card 1/SD card 2** or **USB device 1/USB device 2** > **All** > **Start import/Start export**.

### Note

- Please always note the information in the chapter ⇒ *page 204, General notes on Audi connect (infotainment).*
- For more information on the myAudi account, please refer to **my.audi.com**.
- The imported contacts are stored in the local memory of the directory you are using.
- You can import up to 1000 contacts. You can call up the memory capacity of the directory any time ⇒ *page 189*.
- Never store important data on SD cards or USB mass storage devices. Audi shall not accept any liability whatsoever for the loss of data or media.
- It is not possible to export contacts which have been downloaded from a mobile phone.
- There should be no files or directories on the storage medium other than the contacts you wish to import.

## Other settings

### Telephone settings

Applies to: vehicles with telephone

- ▶ Select: **[MENU]** button > **Telephone** > right control button > **Telephone settings**.

### Call options\*

**Call forward:** Forwarding of incoming calls to your mailbox or to another phone number can be switched on/off. You can use **Check status** to check whether this function is activated or deactivated.

**Call waiting:** If this option is activated , you will be informed of incoming calls when you are on the phone. You can use **Check status** to check whether this function is activated or deactivated.

**Transmit caller ID:** Sending your telephone number in outgoing calls can be activated/deactivated. With the **Network-dependent** option, the setting agreed in your mobile network service contract will be used. The settings apply only to the **Telephone** menu in the MMI system. When the Bluetooth connection has been terminated, ▶

## Telephone

the settings of your mobile phone apply. You can use **Check status** to check whether this function is activated or deactivated.

### Telephone mode\*

On vehicles with a car telephone kit, you can choose between three different telephone modes to optimise the mobile network response:

- **Automatic:** The car telephone automatically switches between the GSM (2G), UMTS (3G) and LTE networks. This depends on the mobile network's availability and reception, and on the position of the vehicle. In this mode, there might be restrictions when using Google Earth or Wi-Fi.
- **Telephony optimised:** The car telephone kit registers with the GSM network (2G). In this mode, the reception is prioritised for making and receiving calls. There may be restrictions when using Google Earth or Wi-Fi.
- **Data service optimised:** The car telephone registers with the GSM (2G), UMTS (3G) or LTE network. This depends on the mobile network, its reception, and the position of the vehicle. In this mode, the reception is prioritised for the use of data services. There may be restrictions when making and receiving calls.

### Ring tone and volume settings<sup>1)</sup>

You can use the **Mute telephone** function to switch ring tone playback via the MMI loudspeakers on/off. Ring tones are played when you select the function **Ring tone**. Select an entry from the list and confirm it. For the settings **Ring tone volume/Message volume**, see ⇨ *page 261*. You can adjust the **Microphone input level** during an active phone call using the rotary pushbutton.

### Network settings\*

Refer to ⇨ *page 259*.

### Serial number (IMEI)\*

The serial number of the telephone module installed in the MMI system is displayed.

### Switch on telephone/Switch off telephone

Applies to: vehicles with car telephone kit

The car telephone will be turned “on” automatically when the ignition is switched on, as long as it was *not* switched off separately the last time it was used.

#### Note

- You can bond several mobile phones to the MMI system; however only two connections are active at a time.
- All bonded Bluetooth devices can be deleted by resetting the **Bluetooth** function to the factory settings ⇨ *page 256*.
- If you select the telephone mode **Automatic** or **Telephony optimised**, there may be network restrictions if you try to use Audi connect infotainment services\* and make telephone calls at the same time.

### Further options

- ▶ Select: **MENU** button > **Telephone** > right control button.

### Connection manager

Refer to ⇨ *page 257*.

### Bluetooth settings\*

Refer to ⇨ *page 258*.

### Online settings\*

Refer to ⇨ *page 258*.

### Wi-Fi settings\*

Refer to ⇨ *page 201, Wi-Fi hotspot*.

### Data connection settings\*

Refer to ⇨ *page 203, Configuring the data connection*.

<sup>1)</sup> Depends on the connected mobile phone

## Directory settings

Applies to: vehicles with telephone

- Select: **MENU** button > **Telephone** > left control button > **Directory** > right control button > **Directory settings**.

### Memory capacity

The **Memory capacity** of the directory will be displayed.

You can manage up to 17,000 contacts with the directory. Up to 4,000 contacts can be loaded from your mobile phone into each directory, and up to 1,000 contacts can be imported from a storage device.

### Sort order

You can sort the contacts in your directory alphabetically according to their **surname** or **first name**.

## Troubleshooting

Applies to: vehicles with telephone

| Subject  | Advice   |
|--|--|
| <b>Connecting</b> the mobile phone to the MMI fails.   | Check if the requirements for connecting a mobile phone are met ⇒ <i>page 173</i> .<br><b>Or:</b> Check if you have accidentally declined the PIN for setting up the connection on your mobile phone. If necessary, repeat the connection procedure ⇒ <i>page 173</i> .  |
| The mobile phone does not support the <b>remote SIM Access Profile</b> (e.g. iPhone).              | Insert your own mini SIM card in the SIM card reader* and use the functions of the car telephone kit independently of your mobile phone.<br>When the mini SIM card is inserted, you can also use the contacts from your mobile phone by connecting the mobile phone to the system via the <b>Directory</b> profile ⇒ <i>page 258</i> . |
| Using the MMI with <b>two SIM cards</b> (in the SIM card reader <i>and</i> in a mobile phone).     | The MMI only ever accesses <i>one</i> SIM card at a time. A mini SIM card inserted in the SIM card reader* has priority over one in a mobile phone.<br>However, you can still access the contacts on another mobile phone via Bluetooth if a mini SIM card is inserted ⇒ <i>page 258</i> .   |
| After the mobile phone was connected <b>not all/none of the contacts</b> were loaded into the MMI. | Avoid using special characters in names.<br>Avoid using contact groups on your mobile phone. ►   |

### Import contacts/Export contacts

Refer to ⇒ *page 187*.

### Download directory

To update the contacts in the MMI, you can download the contacts from your mobile phone manually. Depending on the mobile phone you are using, the Bluetooth connection may have to be disconnected and re-established before you can update the contacts.

### Hiding contacts without a number

If this function is switched on  and if no number has been stored for a contact, the contact is displayed greyed out in the directory.

| Subject   | Advice  |
|---|---|
| Some <b>telephone functions</b> are greyed out/not available.   | The telephone functions will depend on the mobile network service provider and the mobile phone used. For further information, please contact your mobile network service provider, see the operating instructions for your mobile phone, or consult the Audi "Tested mobile phones" database located at <a href="http://www.audi.com/bluetooth">www.audi.com/bluetooth</a> .     |
| Some <b>telephone functions</b> are greyed out/not available, even though the mobile phone supports them.                         | On corporate phones, some Bluetooth settings may not be compatible with the system or the Bluetooth function of your mobile phone may have been deactivated. For more information, contact your system administrator.   |
| Applies to vehicles with Audi phone box: The mini SIM card in the SIM card reader* cannot be connected as an additional phone*.   | Applies to vehicles with Audi phone box: Check if the requirements for connecting a mini SIM card have been met ⇒ <i>page 176</i> . Insert your own mini SIM card in the SIM card reader* and then connect a mobile phone to the MMI system via Bluetooth as an additional phone*. You can then use the <b>Switch primary &amp; additional phone</b> function ⇒ <i>page 175</i> . |
| Applies to vehicles with Audi phone box: Your mobile phone cannot be charged wirelessly or the charging procedure is interrupted. | Applies to vehicles with Audi phone box: Check whether your mobile phone is Qi compatible.<br>Check that your mobile phone is on the middle of the phone symbol in the Audi phone box and that there are <i>no</i> other objects in the Audi phone box.<br>Do not place your remote control key in the Audi phone box together with your mobile phone.                            |



## Audi connect (infotainment)

### Introduction

Applies to: vehicles with Audi connect (infotainment)

Audi connect infotainment services allow online information to be transmitted directly and integrated into the vehicle.

Depending on the equipment in your vehicle, Audi connect infotainment services are available using the options given below.

#### WARNING

Only use Audi connect infotainment services when the traffic conditions allow you to do so safely – risk of accident! Please always observe ⇒ *page 152, Notes on traffic safety.*

#### Note

Refer to ⇒ *page 204, General notes on Audi connect (infotainment)* before using.

### Option 1: Using the embedded SIM card

Applies to: vehicles with an embedded SIM card

The data connection for the Audi connect infotainment services is established via an embedded SIM card (eSIM card) fitted in the vehicle. You can use Audi connect infotainment services right away.

#### CAUTION

- The data connection costs for Audi connect infotainment services are included in the price of Audi connect (infotainment). This does not include services which use the Wi-Fi hotspot, such as online media ⇒ *page 239*. These services require additional paid data plans ⇒ *page 197*. For more information on prices and purchasing, please visit **my.audi.com**.
- Depending on the configuration of the Wi-Fi device you are using (refer to the operating manual of your Wi-Fi device for more details), the SIM card of the device may be used in certain cases to provide the data

connection for Internet-supported apps and services which use the MMI Wi-Fi hotspot. Depending on your network provider, you may be charged for this service, especially if you are using the system abroad. We therefore strongly recommend that you use an unlimited data plan. For more information, contact your service provider. Some example cases are described below:

- Data plan expired/used up
- Data plan not valid abroad
- SIM card in the card reader\* is not a data SIM card
- SIM card in the card reader\* is defective/not valid
- Network is switched automatically due to a low signal strength/data rate of the Wi-Fi hotspot, the eSIM\* or the SIM card in the card reader\*
- Connection to Wi-Fi hotspot interrupted

#### Note

- To make phone calls, you can connect a mobile phone via the Bluetooth remote SIM Access Profile\* ⇒ *page 193* or the Bluetooth handsfree profile ⇒ *page 173*.
- A data connection for Audi connect infotainment services is pre-configured at the factory. However, if configuration is necessary, you can change the data connection settings at any time ⇒ *page 203*.

### Option 2: Using your own SIM card

#### Introduction

Applies to: vehicles with Audi connect (infotainment)

Your own SIM card will be used for all data connections.

You have the following options for using your own SIM card:

- Using the SIM card reader\* ⇒ *page 192* ▶

- Connecting an rSAP-enabled<sup>1)</sup> mobile phone to the MMI via Bluetooth ⇒ *page 193*
- Using a mobile device (e.g. a smartphone) as a personal Wi-Fi hotspot<sup>2)</sup> for the MMI ⇒ *page 195*

### ! CAUTION

- The connection via the eSIM card ⇒ *page 191* is disconnected when you use your own SIM card. **All** data connections for all Audi connect infotainment services will use your SIM card. Depending on your network provider, you may be charged for this service, especially if you are using the system abroad. We therefore strongly recommend that you use an unlimited data plan. For more information, contact your service provider.
- Depending on the configuration of the Wi-Fi device you are using (refer to the operating manual of your Wi-Fi device for more details), the SIM card of the device may be used in certain cases to provide the data connection for Internet-supported apps and services which use the MMI Wi-Fi hotspot. Depending on your network provider, you may be charged for this service, especially if you are using the system abroad. We therefore strongly recommend that you use an unlimited data plan. For more information, contact your service provider. Some example cases are described below:
  - Data plan expired/used up
  - Data plan not valid abroad
  - SIM card in the card reader\* is not a data SIM card
  - SIM card in the card reader\* is defective/not valid
  - Network is switched automatically due to a low signal strength/data rate of the Wi-Fi hotspot, the eSIM\* or the SIM card in the card reader\*
  - Connection to Wi-Fi hotspot interrupted

1) Not available in all markets. Applies to mobile phones with Bluetooth remote SIM Access Profile on vehicles with Audi connect (infotainment) and Audi phone box\*.

2) Not available for all countries and models

### i Note

A data connection for Audi connect infotainment services is pre-configured at the factory. However, if configuration is necessary, you can change the data connection settings at any time ⇒ *page 203*.

### Option 2.1: Using the SIM card reader

Applies to: vehicles with Audi connect (infotainment)



Fig. 168 Mini SIM card (actual size)

### Important

The vehicle must be stationary, and the ignition must be switched on.

A data-enabled mini SIM card must be inserted in the MMI's SIM card reader.

A data connection for Audi connect infotainment services must be configured.

### Inserting a mini SIM card

- ▶ Press the **MENU** button > **Audi connect**.
- ▶ Select and confirm **Activate data connection**. ▶

- ▶ The missing corner of the mini SIM card should be at the front left. Slide the mini SIM card into the slot in the SIM card reader ⇒ *Fig. 168* until you feel it engage.
- ▶ Select and confirm **Enter PIN**. Enter the PIN for your mini SIM card in the MMI.
- ▶ Select and confirm **OK**.
- ▶ To allow the MMI to connect automatically in the future, select and confirm **Yes**.

### After connecting successfully

After connecting successfully, the signal strength and type of connection will appear in the status line of the infotainment display ⑩/⑪ ⇒ *page 161*.

- ▶ Select the desired type of connection for telephone calls: **Telephone installed in vehicle (SIM card)** or **Personal mobile phone (Bluetooth)** ⇒ *page 173*.
- ▶ Confirm the system query of whether an Internet connection should be established with **Yes, always connect if necessary**.

You can now use Audi connect infotainment services.

### Removing a mini SIM card

- ▶ Briefly press the mini SIM card. The mini SIM card will then be ejected from the slot and can be removed.

### ! CAUTION

- The connection via the eSIM card ⇒ *page 191* is disconnected when you use your own mini SIM card. **All** data connections for all Audi connect infotainment services will use your SIM card. Depending on your network provider, you may be charged for this service, especially if you are using the system abroad. We therefore strongly recommend that you use an unlimited data plan. For more information, contact your service provider.
- To avoid damaging the SIM card reader, only use mini SIM cards (25 mm x 15 mm) ⇒ *Fig. 168*. Please contact your service provider for more information on mini SIM cards.

- Should you have inserted a different SIM card size in the SIM card reader, do not under any circumstances attempt to remove it yourself as this may damage the SIM card reader. Please contact a qualified workshop.
- If you use SIM card adapters, the vibrations caused by the movement of the vehicle may cause the SIM card to become detached from the adapter - risk of damage to the SIM card reader.

### i Note

- You can connect a mobile phone via Bluetooth (Handsfree) to make phone calls ⇒ *page 173*.
- You can determine when the MMI system establishes an Internet connection ⇒ *page 203*.
- The mini SIM card must not be removed from the SIM card reader while Audi connect infotainment services are being used.
- In order to use your own mini SIM card for Audi connect infotainment services, you will need a mini SIM card with a data option; to use LTE\*, the SIM card will also need to have an LTE data option.

### Option 2.2: Connecting an rSAP enabled mobile phone via Bluetooth

Applies to: vehicles with Audi connect (infotainment) and Audi phone box



**Fig. 169** Is your mobile phone rSAP enabled? This QR code takes you directly to the mobile device database (data connection costs vary according to your mobile phone contract).

### Important<sup>1)</sup>

Your mobile phone must support the Bluetooth remote SIM Access Profile (Bluetooth rSAP).

For information regarding which Bluetooth connections and functions your mobile phone supports, contact your mobile network service provider or consult the mobile device database at [www.audi.com/bluetooth](http://www.audi.com/bluetooth) ⇒ Fig. 169.

The vehicle must be stationary, and the ignition must be switched on.

The Bluetooth function and the discoverability option of the MMI system ⇒ page 202 and the mobile phone must be activated.

The mobile phone you would like to connect must not be connected actively to any other Bluetooth device. The MMI must not be connected to a mobile phone.

Access to your SIM card (SIM Access) must be activated on your mobile phone.

### Connecting a mobile phone

- ▶ Select: **MENU** button > **Audi connect**.
- ▶ Select and confirm **Activate data connection**.
- ▶ Select and confirm **Connect mobile phone** > **Continue**.
- ▶ Select and confirm the desired mobile phone from the list of Bluetooth devices shown. **Or:** Search for the MMI system via the Bluetooth device search function on your mobile phone.
- ▶ Enter the PIN to establish a connection on your mobile phone. If the PIN is already being displayed on your mobile phone, confirm it on the phone and the MMI. You have about 30 seconds to enter the PIN.



Please note any additional system queries on your mobile phone, e.g. whether the phone should connect automatically in the future. On some mobile phones, you may also need to download the directory separately.

- ▶ You can now enter the PIN code for your SIM card on the MMI.

- ▶ To allow the MMI to connect automatically in the future, select and confirm **Yes**.

### After connecting successfully

After the connection has been established successfully, you will be shown a short message containing information on the profiles used to establish the connection. You can make changes to the profiles via **MENU** > **Settings** > left control button > **MMI settings** > **Connection manager** ⇒ page 258. This can also be done at a later time.

The signal strength symbol , connection type symbol  and Bluetooth symbol  will appear in the status line of the infotainment display when the mobile phone has been connected successfully ⇒ page 161.

- ▶ Confirm the system query of whether an Internet connection should be established with **Yes, always connect if necessary**.

You can now use Audi connect infotainment services.

### CAUTION

- The connection via the eSIM card ⇒ page 191 is disconnected when you use your own SIM card. **All** data connections for all Audi connect infotainment services will use your SIM card. Depending on your network provider, you may be charged for this service, especially if you are using the system abroad. We therefore strongly recommend that you use an unlimited data plan. For more information, contact your service provider.
- In order to use Audi connect infotainment services via the remote SIM Access Profile, you will need a SIM card with a data option; to use LTE\*, the SIM card will also need to have an LTE data option.

<sup>1)</sup> Not available in all markets. Applies to mobile phones with Bluetooth remote SIM Access Profile on vehicles with Audi connect (infotainment) and Audi phone box\*.

**i Note**

- It is only possible to connect a mobile phone via the remote SIM Access Profile on vehicles with the Audi phone box.
- Bluetooth devices only have to be bonded once. Depending on the mobile phone you are using, any devices that have already been bonded to the MMI system are connected automatically when they are within range and the ignition is on. You can bond several mobile phones to the MMI system; however only one connection is active at a time.
- You receive the SIM PIN and the PUK from your mobile network service provider together with the SIM card. If you enter the SIM PIN code incorrectly three times<sup>1)</sup> in a row, the SIM card will be blocked. A PUK (personal unblocking key) must be entered in order to reactivate the SIM card.
- The Bluetooth connection between the system and the mobile phone is automatically terminated when you leave the car.
- For further information regarding your mobile phone, contact your mobile network service provider or refer to the operating instructions for your mobile phone. For information on using a phone in your car, please go online (e.g. [www.audi.com/bluetooth](http://www.audi.com/bluetooth)) or ask an Audi dealer.

**Option 2.3: Using a personal Wi-Fi hotspot**

Applies to: vehicles with Audi connect (infotainment) and personal Wi-Fi hotspot

**Important**

The vehicle must be stationary, and the ignition must be switched on.

Your mobile device and mobile network provider must support the mobile Wi-Fi hotspot function.

The personal Wi-Fi hotspot on your mobile device must be activated.

Other devices must be permitted to access the mobile hotspot.

**Connecting the MMI to a personal hotspot**

- ▶ Select: **MENU** button > **Telephone** > right control button > **Wi-Fi settings** > **Wi-Fi** > **on**.
- ▶ Then select and confirm **Network search**. The devices found will be shown on the infotainment display.
- ▶ Select and confirm your personal Wi-Fi hotspot from the list.
- ▶ You may need to enter the password specified by your mobile device.
- ▶ Select and confirm **OK**.

**! WARNING**

Mobile devices, tablet and laptop computers and devices of a similar weight can only be operated safely when the vehicle is stationary. Like any loose object, they can be catapulted through the vehicle in an accident and cause serious injuries. Always make sure that such devices are securely stowed while you are driving.

**! CAUTION**

The connection via the eSIM card ⇒ *page 191* is disconnected when you use your own SIM card. **All** data connections for all Audi connect infotainment services will use your SIM card. Depending on your network provider, you may be charged for this service, especially if you are using the system abroad. We therefore strongly recommend that you use an unlimited data plan. For more information, contact your service provider.

**i Note**

- The **Connection to personal hotspot** option ⇒ *page 202* will be switched on (✓) automatically during the network search.
- Please contact your mobile network service provider to find out which functions your mobile device supports.

<sup>1)</sup> The number of possible attempts depends on the SIM card.

- Whether other devices can use the mobile Wi-Fi hotspot depends on your data plan.
- Audi recommends that you set a password to protect mobile wireless networks from unauthorised access.
- In order to use Audi connect infotainment services via a personal Wi-Fi hotspot, you will need a SIM card with a data option; to use LTE\*, the SIM card will also need to have an LTE data option.

## Configuring using myAudi

### Configuring Audi connect (infotainment)

Applies to: vehicles with Audi connect (infotainment)

Before you first use certain Audi connect infotainment services, it is necessary to configure them via your personal myAudi account:

- If you do not yet have a personal myAudi account, please register on the Internet at **my.audi.com**.
- Add your vehicle to your myAudi account.
- Activate/configure the Audi connect infotainment services you require for your vehicle in your myAudi account.
- When you call up certain Audi connect infotainment services on the MMI, it may be necessary to also enter your myAudi user data/PIN in order to connect the vehicle to myAudi.

Detailed information on configuration can be found on the Internet at **my.audi.com**.

### Logging into myAudi in the vehicle

Applies to: vehicles with Audi connect (infotainment)

*Before you use some Audi connect infotainment services (e.g. Twitter\*), you will need to connect your vehicle to your myAudi account to use the personal settings stored there.*



Fig. 170 Logging in to myAudi

- ▶ Select: **MENU** button > **Audi connect** > right control button > **Login**.
- ▶ Enter your myAudi user data. **Or**: Enter your eight-character myAudi PIN.
- ▶ Confirm the entry with **OK**.

You can then call up the personal settings from your myAudi account in the vehicle.

### Note

You will receive your myAudi PIN after setting up a myAudi account. For more information, please refer to **my.audi.com**.

## Calling up Audi connect (infotainment)

Applies to: vehicles with Audi connect (infotainment)



Fig. 171 Audi connect (infotainment): Home

Important: The requirements for Audi connect infotainment services must be met ⇒ *page 191*.

- ▶ Select: **MENU** button > **Audi connect**.

- ▶ If necessary, confirm the message shown by selecting **Accept**.

The Audi connect infotainment services available will be listed on the infotainment display ⇒ *Fig. 171*.

You can also filter the Audi connect infotainment services by category:

- ▶ Select: **MENU** button > **Audi connect** > left control button > e.g. **Navigation** for the Audi connect infotainment services in the navigation menu ⇒ *page 200*.

## Audi connect infotainment services

### Basic functions

Applies to: vehicles with Audi connect (infotainment)

Specific functions for individual Audi connect infotainment services may be available in the service's selection menu ⇒ *page 154*. Basic functions can be accessed in the relevant options menu:

- ▶ Select: **MENU** button > **Audi connect** > *desired Audi connect infotainment service* > right control button.

Depending on the Audi connect infotainment service you wish to use, the following basic functions may be available:

#### Save as a preview\*

You can save every Audi connect (infotainment) service as a preview and have it displayed on the Audi connect infotainment homepage ① ⇒ *page 196, Fig. 171*.

#### Show on map

You can have selected content displayed on the map and use it for route guidance.

#### Login

Refer to ⇒ *page 196, Logging into myAudi in the vehicle*.

#### Read<sup>1)</sup>

You can have the MMI read out some types of content.

#### Call\*

If a telephone number has been stored for an entry, you can call the number and, for example, reserve tickets.

#### Start route guidance

If an entry contains a location, e.g. in **City events**, this can be used as a navigation destination. The route guidance function will be started immediately.

#### Change search area

The search area selected can be changed at any time. For more information on search areas, please refer to ⇒ *page 211*.

#### Closing an Audi connect infotainment service

You can close an Audi connect infotainment service at any time and go back to the homepage ⇒ *page 196, Fig. 171*, regardless of which function you were using.

### Data plans

Applies to: vehicles with an embedded SIM card

*In connection with the eSIM for Audi connect infotainment services which use the Wi-Fi hotspot (e.g. online media), you can purchase data plans directly in the vehicle from a selected mobile network provider.*

Important:

You must be registered as the eSIM card owner (**SIM owner**) ⇒ *page 191* in the mobile network provider's customer portal and have purchased a data plan. Further information can be found on the Internet at **my.audi.com**.

You must have activated the in-car data plan purchases function in the network provider's customer portal. ▶

<sup>1)</sup> Not available in all languages.

## Audi connect (infotainment)

- ▶ Select: **MENU** button > **Audi connect** > **Data plans**.

The following functions are available:

### Current data plans

An overview of your current data plans, including the plan period and data volume, is shown on the infotainment display.

### Purchase data plan

- Select and confirm the desired data plan from the list.
- Confirm your purchase of the selected data plan.

### Delete SIM owner

You can delete the SIM owner at any time in the vehicle, for instance when selling the vehicle. This will delete the **SIM owner** in the vehicle, and you will not be able to purchase any data plans.

### Support

You can call the support hotline if you require assistance or have any questions regarding data plans.

#### CAUTION

- Please note that, when using your own SIM card, you will be unable to use any current data plans or purchase any new ones.
- Please always observe the information  in *Wi-Fi hotspot* on page 202.

#### Note

- Please note that any vehicle passenger can delete the SIM owner.
- Please note that any passenger can purchase data plans at the SIM owner's expense when the in-car data plan purchases function is activated. You can set a purchase limit in the mobile network provider's customer portal.
- When selling your vehicle, you should delete the vehicle in the network provider's customer portal to prevent any further purchases at your expense.

- The vehicle and the associated VIN which are stored in the network provider's customer portal are not be deleted automatically when you delete the SIM owner in the vehicle. This must be done separately in the customer portal.
- For journeys abroad, you will need to purchase appropriate data plans.

### Parking information

Applies to: vehicles with Audi connect (infotainment)

Information on places to park and parking fees in the search area selected (e.g. **In immediate vicinity**).

- ▶ Select and confirm **Parking information**.

You can use the right control button to sort the car parks **by distance** or **by availability**.

### Travel information

Applies to: vehicles with Audi connect (infotainment)

Information on landmarks in the search area selected.

- ▶ Select and confirm a landmark to have details displayed.

### Fuel prices

Applies to: vehicles with Audi connect (infotainment)

Information on filling stations with the cheapest prices for your vehicle in the search area selected.

- ▶ Select and confirm **Fuel prices**.

You can use the right control button to sort the fuel prices **by price** or **by distance**.

### Weather

Applies to: vehicles with Audi connect (infotainment)

Information on the current weather and weather forecasts for the search area selected.

- ▶ Select and confirm **Weather**.

You can also have the current weather displayed, e.g. on the map.

- ▶ Select: left control button > *an entry*.



## Flight information

Applies to: vehicles with Audi connect (infotainment)

Information on flights and current arrival/departure times in the search area selected.

- ▶ Select and confirm **Flight information**.

## Train information

Applies to: vehicles with Audi connect (infotainment)

Information on bus stops, train stations and current arrival/departure times in the search area selected.

- ▶ Select and confirm **Train information**.

You can use the right control button to select the train information you require.

## City events

Applies to: vehicles with Audi connect (infotainment)

Information on events of different categories in the search area selected.

- ▶ Select: **City events** > left control button > *a category*.

## Online news

Applies to: vehicles with Audi connect (infotainment)

With this service, you can call up the latest headlines from your preferred news providers in the MMI.

Important: You must have subscribed to news feeds via your myAudi account and your vehicle must be connected to myAudi ⇒ *page 196*.

- ▶ Select: **Online news** > *desired news feed* > *a headline*.

### Note

If you have not yet subscribed to any personal news feeds in your myAudi account, pre-configured news feeds will be shown.

## Twitter

Applies to: vehicles with Audi connect (infotainment)

*You can access the most important functions of your Twitter account via the MMI.*

Important:

You must have linked your myAudi account to Twitter. Further information can be found on the Internet at **my.audi.com**.

You must have linked your vehicle to myAudi ⇒ *page 196*.

- ▶ Select: **Twitter** > left control button > *function desired* (e.g. **Trends**).

You can choose the following categories in the **Twitter** menu:

- **My tweets:** New tweets and tweets you have composed are listed.
- **Home:** All the tweets from people you are following are displayed.
- **Trends:** Topics currently being favoured for discussion within a particular country.

Different functions will be available depending on the Twitter category you choose:

- **New tweet:** You can send a new tweet with the help of ready-made templates or text blocks created personally using myAudi.
- **Refresh:** The selected Twitter function is updated.
- **Favourite:** You can "favourite" a tweet to show that you like it.
- **Retweet:** You can repost a tweet to share it with other people.

### Note

- Further settings (such as your account, language, Tweet privacy, and location settings) *cannot* be changed in the MMI. If you wish to change anything in these menus, please do so on the Twitter website itself.
- Further information on the individual templates can be found online at **my.audi.com**.
- You can only connect *one* Twitter account to your myAudi account. ▶

- Audi connect (infotainment) enables you to access the Twitter service. Audi cannot guarantee that these services will be available indefinitely; this is the responsibility of Twitter.

### Travel guide

Applies to: vehicles with Audi connect (infotainment)

Using the Audi MMI connect app, you can store special destinations on your mobile device (e.g. smartphone) and use them for route guidance on the MMI.

Important:

The **Audi MMI connect** app must have been installed and started on your mobile device.

You must be logged in to your myAudi account in the **Audi MMI connect** app and must have selected your vehicle.

The Wi-Fi function must be activated on your mobile device and on the MMI.

A network connection must be set up on the MMI ⇒ *page 203*.

- ▶ Select: **MENU** button > **Audi connect** > left control button > **Category Information** > **Travel**.

After you call up the travel guide, you will be shown travel tips for the area you are currently in. These include current ratings and the category they belong to.

- ▶ Press the left control button to change the category (e.g. bars nearby).

### WARNING

- Mobile devices, tablet and laptop computers and devices of a similar weight can only be operated safely when the vehicle is stationary. Like any loose object, they can be catapulted through the vehicle in an accident and cause serious injuries. Always make sure that such devices are securely stowed while you are driving.
- No Wi-Fi devices may be used from the front seats in the areas around the airbags while the vehicle is being driven. Please also ob-

serve the safety warnings in the chapter on ⇒ *page 282, Front airbags*.

### CAUTION

Please always observe the information ⇒  in *Wi-Fi hotspot on page 202*.

### Note

- Measurement units, language settings and times are displayed on the infotainment display according to the how they are set in the system settings ⇒ *page 255*.

### Audi connect (infotainment) in the navigation system

Applies to: vehicles with navigation system and Audi connect (infotainment)

- ▶ Select: **MENU** button > **Audi connect** > left control button > **Navigation**.

The following Audi connect infotainment services are currently available:

- Navigation with **Google Earth** and **Google Street View** ⇒ *page 222*.
- **Online point of interest search with speech dialogue system** (e.g. restaurants): For planning a route using the MMI control console ⇒ *page 212* and the speech dialogue system ⇒ *page 164*.
- Adding a destination to your MMI via your **myAudi account** or **Google Maps** ⇒ *page 222*.
- **Online traffic information**: Up-to-the-minute reception of information on accidents, roadworks and other incidents ⇒ *page 226*.
- **myAudi special destinations**: Personal special destinations can be imported to your MMI directly in the vehicle as an online update ⇒ *page 224*.
- **Map update**: Navigation map updates can be imported directly into the vehicle via SD card or as an online update\* ⇒ *page 223*.

### Note

- The Audi connect infotainment **map update** service using an SD card allows you to find out which software version is installed in your vehicle. You can then check whether a

new version is available at **my.audi.com**. You can also have the new navigation data installed by an Audi dealer (carries additional charges).

- Further information on the **myAudi special destinations** and the **map update** can be found online at **my.audi.com**.

### Audi connect (infotainment) for telephones

Applies to: vehicles with Audi connect (infotainment)

- ▶ Select: **MENU** button > **Audi connect** > left control button > **Communication**.

The following Audi connect infotainment services are currently available:

- Creating contacts on your PC via your **myAudi account** and loading the contacts into the directory of your MMI system ⇒ *page 187*.
- Dictating **text messages** or **e-mails** and having them read out\* ⇒ *page 182, Messages*.

### Audi connect (infotainment) in the media menu

Applies to: vehicles with Wi-Fi audio player and Audi connect (infotainment)

- ▶ Select: **MENU** button > **Audi connect** > left control button > **Entertainment**.
- **Wi-Fi audio player:** To access the media centre of your player (e.g. smartphone) connected via Wi-Fi ⇒ *page 238*.
- **Online media and Internet radio:** With assistance from the **Audi MMI connect** app, this function allows you to access and operate various online media services using the MMI.

### WARNING

Mobile devices, tablet and laptop computers and devices of a similar weight can only be operated safely when the vehicle is stationary. Like any loose object, they can be catapulted through the vehicle in an accident and cause serious injuries. Always make sure that such devices are securely stowed while you are driving.

### CAUTION

Please always observe the information ⇒  in *Wi-Fi hotspot on page 202*.

### Note

- Also refer to ⇒ *page 204, General notes on Audi connect (infotainment)*.
- Please contact an Audi dealer for more information on Wi-Fi audio players and for a list of supported devices.

### Further options

Applies to: vehicles with Audi connect (infotainment)

- ▶ Select: **MENU** button > **Audi connect** > right control button.

The following options are available in the overview of the Audi connect infotainment services:

#### Login\*

Refer to ⇒ *page 196, Logging into myAudi in the vehicle*.

#### Connection manager

Refer to ⇒ *page 257*.

#### Licence periods

The validity and the time remaining on your licences is displayed. If the **Licence expiry warning** function is switched on , a message will be displayed before the licence expires.

#### Refresh

The content of the Audi connect infotainment service selected or the entire Audi connect (infotainment) list is updated.

### Wi-Fi hotspot

Applies to: vehicles with Wi-Fi hotspot

*You can use your MMI system as a Wi-Fi hotspot for connecting to the Internet on up to eight Wi-Fi devices. Small, light Wi-Fi devices that are not permanently attached to the vehicle must only be operated from the rear seats while the vehicle is moving.*

Important: The ignition must be switched on. ▶

### Setting a destination from the map (via MMI touch)

Applies to: vehicles with navigation system (flash memory) and MMI touch pad

A location on the map can be set as a destination.

- **To set a convenient map scale:** Turn the rotary pushbutton clockwise or anti-clockwise.
- **To activate the crosshairs:** Press the rotary pushbutton. The crosshairs will appear on the map.
- **To move the crosshairs:** Use the MMI touch pad to move the crosshairs to the destination ⇒ page 156.
- **To use the destination for route guidance:** Press the rotary pushbutton when the crosshairs are displayed. If you wish to set a stopover, select and confirm **Set as stopover** and then **Start route guidance**.
- **To hide the crosshairs:** Press the **[BACK]** button.

**Additional information on the point selected with the crosshairs:** If you use the crosshairs to preselect a location on the map, any existing information on this location (e.g. road name, address or special destinations) will be displayed ⑫ ⇒ page 219, Fig. 182.

### Using home address/favourite as the destination

Applies to: vehicles with navigation system

The home address option is a quick and easy way to have the system guide you home. The favourites make it easier to access destinations you require regularly.

- ▶ Press the **[NAV/MAP]** button repeatedly until the **Enter destination** menu is displayed ⇒ page 207, Fig. 172.

#### Using the home address as the destination

Important: A home address must have been stored ⇒ page 215.

Your **home address** is displayed in the **Enter destination** menu ② ⇒ page 207, Fig. 172.

- Select: *Home address* > **Start route guidance**.

### Using a favourite as the destination

Important: At least one favourite must have been stored as a destination ⇒ page 216.

- Enter at least the first three letters of the desired favourite in the entry field for the search function. The favourites found will be shown on the infotainment display ④ ⇒ page 207, Fig. 172.
- Select and confirm the desired item.
- Select and confirm **Start route guidance**.

#### **i** Note

- Further home address settings can be found on ⇒ page 215.
- Further favourites settings can be found on ⇒ page 216.

### Using a destination from the directory

Applies to: vehicles with navigation system

You can navigate directly to entries in the directory.

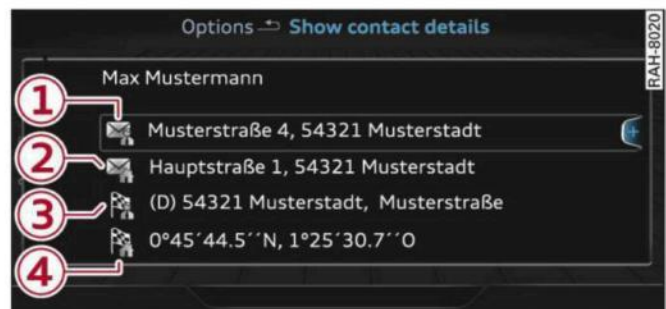

Fig. 174 Possible directory contacts

Important: A postal address with navigation data must be available for a contact or a navigation destination must have already been added for a contact ⇒ page 216, *Directory contacts*.

- ▶ Press the **[NAV/MAP]** button repeatedly until the **Enter destination** menu is displayed ⇒ page 207, Fig. 172.
- ▶ Select: left control button > **Directory** > a contact.

Directory contacts are displayed in alphabetical order and are displayed together with a location symbol:

- ① Business postal address
- ② Private postal address

③ Business navigation destination

④ Private navigation destination

- Select and confirm a postal address or a navigation destination. If you select a navigation destination, route guidance is started immediately.
- If you select a postal address, you can check the address details again.
- You can then select and confirm **Start route guidance**.

Further directory functions in the navigation system can be found on ⇒ *page 216*.

**i Note**

- Addresses which you have imported from your mobile phone into the MMI can also be used as navigation destinations.
- If a directory contact is greyed out, no navigation destination/postal address has yet been added for the contact.

**Point of interest search (special destinations)**

Applies to: vehicles with navigation system



Fig. 175 Example: Searching for a special destination

- ▶ Press the **NAV/MAP** button repeatedly until the **Enter destination** menu is displayed ⇒ *page 207, Fig. 172*.
- ▶ Select: left control button > **Special destinations**.
- **To change the search area:** Select and confirm **Search area** and then a search area from the list.

The following search categories are available:

**In immediate vicinity:** You can select special destinations from different categories. The special destinations are displayed in a list, starting with destinations in the immediate vicinity and going up to destinations within a radius of 200 km.

**In vicinity of route:** Special destinations along the route can only be selected when the route guidance function is active. The special destinations are located directly on or in the immediate vicinity of your route. You can also select special destinations from different categories. For example, you can look for a hotel or a car park at the destination.

**In vicinity of destination/In vicinity of stopover:** Special destinations near the destination/stopover can only be selected when the route guidance function is active. You can also select special destinations from different categories. For example, you can look for a hotel or a car park at the destination.

**In new town:** Select a country or search in a new town. Enter the name of the desired town. You can select special destinations from different categories. You can use this function to find special destinations in any town irrespective of the destination currently set or the vehicle position.

- **To find the name of a special destination in the selected search area:** Enter the name of the special destination.
- **To search for a special destination in a specific category:** Choose **Select category**. Select and confirm a category, for example **Restaurant**.

**myAudi special destinations\*<sup>1)2)</sup>**

In **myAudi special destinations**, you can find personal special destinations which you have added in your myAudi account and imported to the MMI using an SD card or online\* ⇒ *page 224*.

- **To add further myAudi special destinations:** Select the right control button > **Import** ▶

1) Important: You must have created a myAudi account at **my.audi.com**, added a vehicle to the account and stored a destination.

2) This function is not available in the Mexican market.

- ▶ Select: **MENU** button > **Telephone** > right control button > **Wi-Fi settings**.

The following settings can be made:

### Wi-Fi

The Wi-Fi hotspot is deactivated when the vehicle leaves the factory. Switch the Wi-Fi hotspot **on** before establishing an Internet connection between your vehicle and your Wi-Fi device.

- **on**: The MMI's Wi-Fi hotspot is activated and visible to other devices. You can connect your Wi-Fi device to the MMI.
- **off**: The MMI's Wi-Fi hotspot is deactivated. Wi-Fi devices will not be able to connect to the Internet.

### Network key

The Wi-Fi connection between your vehicle and the Wi-Fi device (laptop or mobile phone) is encrypted. Before a connection can be established, you must enter the following values/settings when setting up your Wi-Fi device (these values can be edited as required):

- **Access point (SSID)**: Name of the Wi-Fi network.
- **Password**: A random MMI password is set at the factory. This password can be changed. The encryption type WPA2 requires the password to be at least 8 characters long. Please select a secure password.
- **Discoverability**: To switch the discoverability of your Wi-Fi network on () or off.

### Network search<sup>1)</sup>

A list of the Wi-Fi networks available near you is displayed.

### Connection to personal hotspot<sup>1)</sup>

The Wi-Fi hotspot of the MMI is activated. The MMI can establish an Internet connection to a personal Wi-Fi hotspot (e.g. smartphone). You can search for your personal hotspot and connect to the MMI using **Network search**. For more information, please refer to ⇒ *page 195*.

This mode is not available if your own mini SIM card is inserted in the SIM card reader.

### WARNING

- The Audi connect infotainment services should only be used via a Wi-Fi hotspot when the vehicle is stationary or from the rear seats if the vehicle is in motion – risk of accident!
- Mobile devices, tablet and laptop computers and devices of a similar weight can only be operated safely when the vehicle is stationary. Like any loose object, they can be catapulted through the vehicle in an accident and cause serious injuries. Always make sure that such devices are securely stowed while you are driving.
- No Wi-Fi devices may be used from the front seats in the areas around the airbags while the vehicle is being driven. Please also observe the safety warnings in the chapter on ⇒ *page 282, Front airbags*.
- Do not allow the features of the Wi-Fi hotspot to distract you from watching the traffic – taking your eyes off the road can cause an accident.

### CAUTION

- Depending on the configuration of the Wi-Fi device you are using (refer to the operating manual of your Wi-Fi device for more details), the SIM card of the device may be used in certain cases to provide the data connection for Internet-supported apps and services which use the MMI Wi-Fi hotspot. Depending on your network provider, you may be charged for this service, especially if you are using the system abroad. We therefore strongly recommend that you use an unlimited data plan. For more information, contact your service provider. Some example cases are described below:
  - Data plan expired/used up
  - Data plan not valid abroad

<sup>1)</sup> Not available in all markets.

- SIM card in the card reader\* is not a data SIM card
- SIM card in the card reader\* is defective/not valid
- Network is switched automatically due to a low signal strength/data rate of the Wi-Fi hotspot, the eSIM\* or the SIM card in the card reader\*
- Connection to Wi-Fi hotspot interrupted
- Applies when using the embedded SIM card: The data connection costs for Audi connect infotainment services are included in the price of Audi connect (infotainment). This does not include services which use the Wi-Fi hotspot, such as online media ⇒ *page 239*. These services require additional paid data plans ⇒ *page 197*. For more information on prices and purchasing, please visit [my.audi.com](http://my.audi.com).
- Applies when using your own SIM card: The connection via the eSIM card ⇒ *page 191* is disconnected when you use your own SIM card. **All** data connections for all Audi connect infotainment services will use your SIM card. Depending on your network provider, you may be charged for this service, especially if you are using the system abroad. We therefore strongly recommend that you use an unlimited data plan. For more information, contact your service provider.
- Please note that it is your responsibility to take precautions regarding data protection, anti-virus protection and protection against loss of data on mobile devices used to connect to the Internet via the Wi-Fi hotspot.

### Note

- In vehicles without Audi connect (infotainment)\*, the Wi-Fi hotspot can only be used for the Wi-Fi audio player\*. A data connection to the Internet cannot be established.
- Further information on Audi connect infotainment services can be found on the Internet at [www.audi.com](http://www.audi.com).

## Configuring the data connection

Applies to: vehicles with Audi connect (infotainment)

*A data connection for Audi connect infotainment services is pre-configured at the factory. However, if a configuration is necessary, you can adjust the settings as described below.*

- ▶ Select: **MENU** button > right control button > **Connection manager**.
- ▶ Select: right control button > **Online settings** > **Data connection settings**.

You can select when you would like the system to establish an Internet connection in the **Data connection settings** menu. The online connection is ended automatically when a requested Audi connect infotainment service no longer requires any further data.

The following options are available:

### Connection setup

- **with request:** A data connection will only be established on request.
- **no request:** A data connection will be established automatically for the use of Audi connect infotainment services.
- **never:** A data connection will not be established. It is then not possible to call up Audi connect infotainment services.

When a data connection has been established, a symbol indicating the active data connection  ⇒ *page 161, Fig. 156* appears in the status line of the infotainment display.

You can cancel an active data connection manually by setting the **Connection setup** option to **never**.

### Data roaming

The **Data roaming** function is deactivated when the vehicle leaves the factory. **Data roaming** must be activated () before you can use a data connection abroad. This setting is saved for the current SIM card/the mobile phone currently connected.

### Audi connect (MMI)

With the **Audi connect (MMI)** function, you can **allow** or **deny** the use of Audi connect infotainment services if the connection is set to **no request** or **with request**.

### Wi-Fi devices\*

You can use the **Wi-Fi devices** function to **allow** or **deny** a connection to the Internet.

### Connection settings

Depending on the SIM card used, the connection may be configured automatically. However, these settings can be changed. For more information, contact your service provider.

- **APN:** The system access point depends on your mobile network service provider and is assigned automatically.
- **User name:** The user name for your online profile is assigned by your mobile network service provider.
- **Password:** The password for your online profile is assigned by your mobile network service provider.
- **Use settings:** The changed connection settings are stored.

### Reset configuration

An online profile is created and configured automatically. The **Connection settings** you have changed manually are reset to the default settings.

#### **WARNING**

- Do not allow the features of the Wi-Fi hotspot to distract you from watching the traffic – taking your eyes off the road can cause an accident.
- Mobile devices, tablet and laptop computers and devices of a similar weight can only be operated safely when the vehicle is stationary. Like any loose object, they can be catapulted through the vehicle in an accident and cause serious injuries. Always make sure that such devices are securely stowed while you are driving.

- No Wi-Fi devices may be used from the front seats in the areas around the airbags while the vehicle is being driven. Please also observe the safety warnings in the chapter on ⇒ *page 282, Front airbags*.

#### **CAUTION**

Please always observe the information ⇒  in *Wi-Fi hotspot on page 202*.

#### **Note**

- According to the factory settings, the data connection will be interrupted initially when you travel abroad to protect you from unexpected roaming charges. If you want to use Audi connect infotainment services abroad, you must first activate the **Data roaming** option.
- For more information on roaming charges, contact your service provider.
- Further information can be found on the Internet at **www.audi.com**.

## General notes on Audi connect (infotainment)

### Audi connect infotainment services

Applies to: vehicles with Audi connect (infotainment)

#### **Note**

- The mobile phone standard LTE\* is not available for use in all countries. For further information, please consult an Audi dealer or your mobile network service provider.
- Whether Audi connect infotainment services can be used depends on the availability of services provided by third parties.
- Audi connect infotainment services are only available within the mobile network area covered by your network provider.
- The availability, scope, provider and price of the services offered can vary, as can the way in which the services are displayed on the screen. These variations depend on your country, model, model year, device and mobile phone contract.



- Further information on Audi connect (infotainment) is also available on the Internet at **www.audi.com**. For information on the conditions of your mobile phone contract, please contact your mobile network service provider.
- Please also observe the notes in the chapter ⇒ *page 172, Telephone*.

**Data protection**

Applies to: vehicles with Audi connect (infotainment)

**Note**

- AUDI AG collects, processes, transmits and uses the personal data you provide in accordance with legal requirements to ensure that the individual Audi connect infotainment services are provided and function properly. You can use our myAudi platform, for example, to activate further Audi connect infotainment services and to transfer data to and from your vehicle. You must register once in order to be able to connect your vehicle to the platform. AUDI AG collects, processes, transmits and uses the personal data you must provide for the registration as is necessary to ensure that AUDI AG can provide the services and that you can

- use them. Your data are not passed on to third parties. Using the myAudi platform and your mobile phone, you can transmit data to your vehicle for the functions of your Audi connect infotainment services and allow certain vehicle data to be transmitted from your vehicle.
- If you activate certain information services included in your Audi connect (infotainment) portfolio, you can use the corresponding functions directly in your vehicle after entering your personal identification data (for example for access to social networks). In this case we pass on your identification data to the corresponding service provider. You can then access your personal content via a secure communication channel. This content is displayed and can be used in the vehicle. AUDI AG will not store your personal content. The necessary connection data are processed and used in accordance with legal requirements to ensure that the services are provided and function properly.
- Further information can also be found on the MMI in the options menu of the Audi connect infotainment service selected and on the Internet at **www.audi.com**.

**Troubleshooting**

Applies to: vehicles with Audi connect (infotainment)

| Subject  | Advice   |
|--|--|
| <b>Audi connect infotainment services:</b> Some Audi connect infotainment services are greyed out/not available. | Before you first use some Audi connect infotainment services, it is necessary to activate/configure them via your personal myAudi account. Detailed information can be found on the Internet at <b>my.audi.com</b> . |
| <b>Wi-Fi hotspot:</b> No Wi-Fi connection is possible.   | Delete all existing Wi-Fi connections on your mobile device and restart it.  |
| <b>Wi-Fi hotspot:</b> The data connection is interrupted.  | Check whether the <b>Connection to personal hotspot</b> function is switched on ⇒ <i>page 201</i> . Switch the function off when you are not using a personal hotspot.   |

## Audi connect (infotainment)

---

| Subject  | Advice  |
|--|---|
| <b>Personal Wi-Fi hotspot: Network search</b> is not possible (greyed out).  | The Wi-Fi hotspot must be switched on in order to start a network search for your personal Wi-Fi hotspot ⇒ <i>page 202</i> .  |
| Applies to: vehicles with an embedded SIM card:<br><b>Wi-Fi audio player/online media:</b><br>No data connection is established. | Applies to: vehicles with an embedded SIM card:<br>Check that you currently have a valid data plan. Plans vary according to the period of validity (e.g. 7 days), data volume (e.g. 200 MB) and the countries where they are available. |

# Navigation

## Introduction

Applies to: vehicles with navigation system

Depending on your vehicle's equipment, the navigation data for your navigation system is located either on the SD card provided or on the internal flash drive of the MMI. The information given here always applies to both navigation systems unless otherwise stated, e.g. "Applies to vehicles with navigation system (SD card)".

### CAUTION

The navigation system is designed for use only with the SD card provided. AUDI AG shall not accept any liability for the consequences of the use of other SD cards.

## Setup

Applies to: vehicles with navigation system (SD card)

- ▶ Slide the SD card with navigation data (provided) into the slot in the SD card reader until you feel it engage. The missing corner of the SD card should be at the front right.

### CAUTION

Do not store the SD card with navigation data outside of the SD card reader slot (e.g. in the glove box) for long periods. External factors, such as excessive heat, may cause data loss. Audi recommends that you make a backup copy of the SD card and store it in a location protected from external factors (outside of the vehicle).

### Note

- Please note that the navigation system is immediately no longer available if the SD card is removed from the SD card reader.
- Store the SD cards in a suitable case to protect them from dirt and dust and to avoid damage.

## Calling up the navigation menu

Applies to: vehicles with navigation system

The navigation system guides you directly to your destination, avoiding traffic obstructions and using alternative routes if desired.

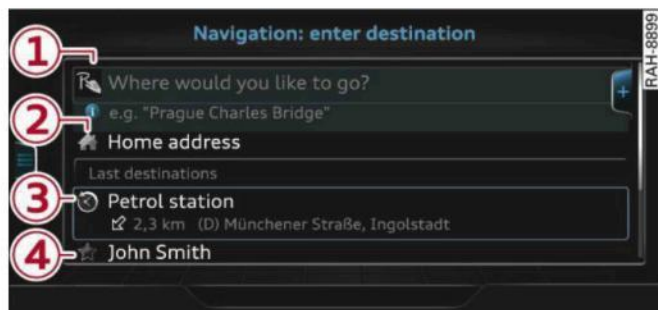

Fig. 172 Illustration: Entering a destination

- ▶ Select: **NAV/MAP** button.

After calling up the navigation system, the **Enter destination** menu will be displayed. The following information can be shown on the infotainment display:

|   |                                     |     |
|---|-------------------------------------|-----|
| ① | Entry field for the search function | 208 |
| ② | Home address                        | 210 |
| ③ | Destinations recently travelled to  | 208 |
| ④ | Stored favourites                   | 210 |

If you have connected a mobile phone to the MMI, your directory contacts are then listed if you have added navigation data to at least one contact.

The menu item **Favourites** ④ ⇒ Fig. 172 and your directory contacts are shown in the **Enter destination** menu when you have entered one or more letters in the entry field.

### Switching between destination entry and map:

- Press the **NAV/MAP** button repeatedly until the map is displayed. **Or:** Press the left control button > **Switch to map**.

### WARNING

- Today's driving conditions require the full attention of drivers. Please always note the information in the chapter ⇒ page 263, *Safe driving*.
- Pay attention to traffic rules when driving.

- The route calculated by the navigation system is a recommendation of how best to reach a destination. Pay attention to traffic lights, no stopping signs, lane change restrictions, one-way streets, etc.

### CAUTION

- Should the navigation directions contradict the current traffic regulations, you must always follow the traffic regulations.
- The volume should only be set at a level which enables you to hear distant police and emergency vehicles clearly - failure to do so could result in an accident.

### Note

- Snow or other obstructions on the GPS aerial or interference caused by trees or large buildings could affect the reception of the satellite signals and make positioning difficult. GPS reception and vehicle positioning can also be adversely affected by deactivation or a malfunction of several satellites.
- Road names can change; therefore the names stored on the MMI may be different from the actual names in exceptional cases.

## Entering a destination

### Searching for navigation destinations

Applies to: vehicles with navigation system

*With the search function, you can use the MMI touch pad\* or the speller for letters/numbers to enter navigation destination information in any order (e.g. Forest Road 20 London). You can search for special destinations, contacts, recent destinations or favourites in the same way to help you navigate to the desired address.*

Press the **NAV/MAP** button repeatedly until the **Enter destination** menu is displayed ⇒ page 207, Fig. 172.

- ▶ Push the rotary pushbutton upwards. The entry field will be displayed ① ⇒ page 207, Fig. 172.
- Enter one or more search terms in the entry field.

- If appropriate, confirm an autocomplete suggestion\* or a suggested word\*. Refer to ⇒ page 159, Speller for letters/numbers.
- Turn the rotary pushbutton clockwise to switch to the results list.
- Select a destination from the results list and confirm it.
- Select and confirm **Start route guidance**.

The route will be displayed as an overview on the map. Route guidance is already active.

### Narrowing the search area

All countries are preselected for the search function at the factory.

- In the input menu ① ⇒ page 207, Fig. 172, select the right control button > **Country selection**.
- Select the country (✓) which you would like to search in. This will limit the number of results and speed up the search. The entry selected in the country selection menu will be stored.

### Note

- The terms suggested by the MMI depend on the destinations to which you have recently driven.
- Up to 50 entries are stored in the list of destinations to which you have recently driven.
- For more information on the search function, please refer to ⇒ page 160.

### Loading last destination

Applies to: vehicles with navigation system

*The destinations you have most recently driven to are stored automatically and can be loaded directly as new destinations.*

Important: You must have set a destination in the past.

- ▶ Press the **NAV/MAP** button repeatedly until the **Enter destination** menu is displayed ⇒ page 207, Fig. 172.

The destinations to which you have recently driven are listed directly in the **Enter destination** menu under your home address and marked with the symbol ③ ⇒ page 207, Fig. 172. ▶

- Select and confirm one of the recently set destinations from the list.
- Select and confirm **Start route guidance**.

### Deleting recent destinations

- Select and confirm one of the recently set destinations from the list.
- Select: right control button > **Delete destination** > **Delete this recent destination** or **Delete all recent destinations**.

The destination selected or all the recent destinations will be deleted and no longer displayed in the **Enter destination** menu.

### Entering an address

Applies to: vehicles with navigation system

*As an alternative to the search function, you can also enter an address step by step.*

- ▶ Press the **NAV/MAP** button repeatedly until the **Enter destination** menu is displayed  
⇒ page 207, Fig. 172.
- ▶ Select: left control button > **Enter address**.
- **To enter a destination via the country:** Select and confirm **Country**. Select a country from the list and confirm it. **Or:** Search for a country via the entry field.
- **To enter a destination via the town/post code:** Select and confirm **Town/post code**. Enter a town or a post code. **Or:** Select and confirm a town from the list.
- Select and confirm additional details for the destination such as **Street**, **House number** or **Centre**.
- **To enter a destination via an intersection\*:** Select and confirm **Intersection**. You must already have entered a street. Select a street directly from the list and confirm it. **Or:** Search for a street via the entry field.
- Select and confirm **Start route guidance**.

### Setting a destination from the map (via rotary pushbutton)

Applies to: vehicles with navigation system (SD card) and rotary pushbutton with joystick function

*A location on the map can be set as a destination.*



**Fig. 173** Moving the crosshairs (MMI control console with rotary pushbutton with joystick function)

- ▶ Press the **NAV/MAP** button repeatedly until the map is displayed.
- **To set a convenient map scale:** Turn the rotary pushbutton clockwise or anti-clockwise.
- **To activate the crosshairs:** Press the rotary pushbutton.
- **To navigate in the legend menu:** Select and confirm the crosshairs mode in the legend menu (2) ⇒ Fig. 173. The crosshairs will appear on the map (1).
- **To move the crosshairs:** Turn the rotary pushbutton in the direction you would like to move the crosshairs (see magnified detail ⇒ Fig. 173). Press and hold the rotary pushbutton until the crosshairs are at the desired position on the map. Press the **BACK** button.
- **To use the destination:** Select **OK** in the legend menu (3) ⇒ Fig. 173. If you wish to set a stopover, select and confirm **Set as stopover** and then **Start route guidance**.
- **To hide the crosshairs:** Press the **BACK** button twice.

**Additional information on the point selected with the crosshairs:** If you use the crosshairs to preselect a location on the map, any existing information on this location (e.g. road name, address or special destinations) will be displayed (12) ⇒ page 219, Fig. 182.

### Setting a destination from the map (via MMI touch)

Applies to: vehicles with navigation system (flash memory) and MMI touch pad

A location on the map can be set as a destination.

- **To set a convenient map scale:** Turn the rotary pushbutton clockwise or anti-clockwise.
- **To activate the crosshairs:** Press the rotary pushbutton. The crosshairs will appear on the map.
- **To move the crosshairs:** Use the MMI touch pad to move the crosshairs to the destination ⇒ page 156.
- **To use the destination for route guidance:** Press the rotary pushbutton when the crosshairs are displayed. If you wish to set a stopover, select and confirm **Set as stopover** and then **Start route guidance**.
- **To hide the crosshairs:** Press the **[BACK]** button.

**Additional information on the point selected with the crosshairs:** If you use the crosshairs to preselect a location on the map, any existing information on this location (e.g. road name, address or special destinations) will be displayed ⑫ ⇒ page 219, Fig. 182.

### Using home address/favourite as the destination

Applies to: vehicles with navigation system

The home address option is a quick and easy way to have the system guide you home. The favourites make it easier to access destinations you require regularly.

- ▶ Press the **[NAV/MAP]** button repeatedly until the **Enter destination** menu is displayed ⇒ page 207, Fig. 172.

#### Using the home address as the destination

Important: A home address must have been stored ⇒ page 215.

Your **home address** is displayed in the **Enter destination** menu ② ⇒ page 207, Fig. 172.

- Select: *Home address* > **Start route guidance**.

### Using a favourite as the destination

Important: At least one favourite must have been stored as a destination ⇒ page 216.

- Enter at least the first three letters of the desired favourite in the entry field for the search function. The favourites found will be shown on the infotainment display ④ ⇒ page 207, Fig. 172.
- Select and confirm the desired item.
- Select and confirm **Start route guidance**.

#### **i** Note

- Further home address settings can be found on ⇒ page 215.
- Further favourites settings can be found on ⇒ page 216.

### Using a destination from the directory

Applies to: vehicles with navigation system

You can navigate directly to entries in the directory.

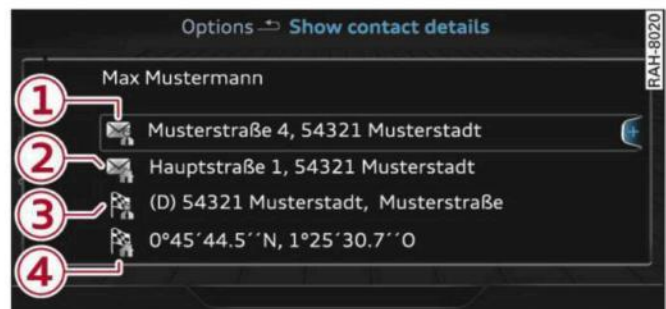

Fig. 174 Possible directory contacts

Important: A postal address with navigation data must be available for a contact or a navigation destination must have already been added for a contact ⇒ page 216, *Directory contacts*.

- ▶ Press the **[NAV/MAP]** button repeatedly until the **Enter destination** menu is displayed ⇒ page 207, Fig. 172.
- ▶ Select: left control button > **Directory** > a contact.

Directory contacts are displayed in alphabetical order and are displayed together with a location symbol:

- ① Business postal address
- ② Private postal address

- ③ Business navigation destination
- ④ Private navigation destination
- Select and confirm a postal address or a navigation destination. If you select a navigation destination, route guidance is started immediately.
- If you select a postal address, you can check the address details again.
- You can then select and confirm **Start route guidance**.

Further directory functions in the navigation system can be found on ⇒ *page 216*.

### **i** Note

- Addresses which you have imported from your mobile phone into the MMI can also be used as navigation destinations.
- If a directory contact is greyed out, no navigation destination/postal address has yet been added for the contact.

### Point of interest search (special destinations)

Applies to: vehicles with navigation system



Fig. 175 Example: Searching for a special destination

- ▶ Press the **NAV/MAP** button repeatedly until the **Enter destination** menu is displayed ⇒ *page 207, Fig. 172*.
- ▶ Select: left control button > **Special destinations**.
- **To change the search area:** Select and confirm **Search area** and then a search area from the list.

The following search categories are available:

**In immediate vicinity:** You can select special destinations from different categories. The special destinations are displayed in a list, starting with destinations in the immediate vicinity and going up to destinations within a radius of 200 km.

**In vicinity of route:** Special destinations along the route can only be selected when the route guidance function is active. The special destinations are located directly on or in the immediate vicinity of your route. You can also select special destinations from different categories. For example, you can look for a hotel or a car park at the destination.

**In vicinity of destination/In vicinity of stopover:** Special destinations near the destination/stopover can only be selected when the route guidance function is active. You can also select special destinations from different categories. For example, you can look for a hotel or a car park at the destination.

**In new town:** Select a country or search in a new town. Enter the name of the desired town. You can select special destinations from different categories. You can use this function to find special destinations in any town irrespective of the destination currently set or the vehicle position.

- **To find the name of a special destination in the selected search area:** Enter the name of the special destination.
- **To search for a special destination in a specific category:** Choose **Select category**. Select and confirm a category, for example **Restaurant**.

### myAudi special destinations\*<sup>1)2)</sup>

In **myAudi special destinations**, you can find personal special destinations which you have added in your myAudi account and imported to the MMI using an SD card or online\* ⇒ *page 224*.

- **To add further myAudi special destinations:** Select the right control button > **Import** ▶

1) Important: You must have created a myAudi account at **my.audi.com**, added a vehicle to the account and stored a destination.

2) This function is not available in the Mexican market.

**myAudi special destinations.** Log in to myAudi if necessary. Select and confirm the desired medium from the source list (e.g. **SD card 1**).

### Note

- Further information on the myAudi special destinations can be found online at **my.audi.com**.
- The distances to special destinations are shown as the crow flies from your current location. The actual driving distance between your current position and the special destination is updated automatically. However, the list of special destinations is not sorted again.
- Sometimes there are destination entries in the list that cannot be displayed completely because they are too long. If you select one of these entries with the rotary pushbutton, detailed information on the selected entry will be displayed automatically after a few seconds.

### Online point of interest search (online search)

Applies to: vehicles with navigation system and Audi connect (infotainment)

*You can look for special destinations online.*

**Important:** The requirements for Audi connect (infotainment) must be met ⇒ *page 191*.

- ▶ Press the **NAV/MAP** button repeatedly until the **Enter destination** menu is displayed ⇒ *page 207, Fig. 172*.
- ▶ Select: left control button > **Online search**. The search area that was last set will be displayed in the entry field.
- **To change the search area:** Select: right control button > **Select search area**.
- **To find an online destination in the selected search area:** Enter a new town/country if necessary. Enter a search term (e.g. hotel) and press the rotary pushbutton. Select and confirm an online destination from the list.
- **To search for an online destination in a specific category:** Select and confirm **Select category**.

**ry.** Select and confirm a category, for example **Restaurant**.

Please see ⇒ *page 211, Point of interest search (special destinations)* for information on which search areas are available.

You can also use the speech dialogue system to search for online destinations ⇒ *table on page 168*.

### Note

- Please always note the information in the chapter ⇒ *page 204, General notes on Audi connect (infotainment)*.
- Further information can be found on the Internet at **www.audi.com**.

### Calling up destinations from myAudi account

Applies to: vehicles with navigation system and Audi connect (infotainment)

*You can import personal navigation destinations from your myAudi account to the MMI.*

**Important:**

The requirements for Audi connect (infotainment) must be met ⇒ *page 191*.

You must have created a myAudi account at **my.audi.com**, added a vehicle to the account and stored one or more personal destinations.

- ▶ Press the **NAV/MAP** button repeatedly until the **Enter destination** menu is displayed ⇒ *page 207, Fig. 172*.
- ▶ Select: left control button > **myAudi contacts**.
- ▶ If necessary, enter your myAudi login details or your myAudi PIN ⇒ *page 196*. The contacts stored in myAudi will be displayed.
- Select and confirm a contact.
- Select and confirm a private/business navigation destination.
- If desired, select and confirm **Start route guidance**.

### Note

- You only have to enter your myAudi login details once.



- You will receive your myAudi PIN after setting up a myAudi account.
- Further information can be found on the Internet at [www.audi.com](http://www.audi.com).

### Entering a destination using coordinates

Applies to: vehicles with navigation system

- ▶ Press the **NAV/MAP** button repeatedly until the **Enter destination** menu is displayed  
⇒ *page 207, Fig. 172.*
- ▶ Select: left control button > **Geographic coordinates.**
  - Select **Latitude/Longitude.**
  - Press the rotary pushbutton to select the individual values.
  - Turn the rotary pushbutton clockwise or anticlockwise to change the selected value.
  - Select and confirm **Start route guidance.**

### Adding a stopover

Applies to: vehicles with navigation system

*You can enter a new destination while route guidance is active.*



**Fig. 176** Example: Active route guidance with stopover

Important: The route guidance function must already be active.

- ▶ Press the **NAV/MAP** button repeatedly until the **Enter destination** menu is displayed  
⇒ *page 207, Fig. 172.*

### Entering a destination as a stopover

- Enter a destination in the entry line  
⇒ *page 208.*
- Select a destination from the results list and confirm it.
- Select and confirm **Set as stopover.**

### Deleting a stopover

- Push the rotary pushbutton upwards. The search function and the active route guidance will be displayed.
- Select and confirm **Delete stopover** ②  
⇒ *Fig. 176.*
- The stopover will be deleted.

### Stopping route guidance

Applies to: vehicles with navigation system

Important: The route guidance function must be active.

- ▶ Press the **NAV/MAP** button repeatedly until the **Enter destination** menu is displayed  
⇒ *page 207, Fig. 172.*
- ▶ Turn the rotary pushbutton to the left until the active route guidance is displayed ⇒ *page 213, Fig. 176.*
- ▶ Select and confirm **Stop route guidance** ①  
⇒ *page 213, Fig. 176.* The destination will be deleted. **Or:** Select the right control button > **Stop route guidance.**

### Further options when entering a destination

Applies to: vehicles with navigation system

Depending on the function chosen, the following options may be available to you when you are entering a destination:

- ▶ Press the right control button.

**Stop route guidance:** The route guidance function must be active. The route guidance will be stopped. For more information, please refer to ⇒ *page 213.*

**Country information:** With this option, you can view the speed limits for towns and country roads in the country you have selected. This information is displayed automatically when you cross a border in the route information ⑦  
⇒ *page 219, Fig. 181* if this is activated  
⇒ *page 221.*

**Country selection:** Select a country (☑) which, for example, you wish to include in your searches ⇒ *page 208.* Alternatively, select all countries. ▶

**Route criteria:** Refer to ⇒ *page 217, Route criteria*.

**Show location on map:** Important: You must have selected a destination from the results list. The destination entered will be shown on the map.

**Parking at this location\*:** Important: You must have selected a destination from the results list. All the parking facilities near the location selected are shown on the infotainment display.

**Delete:** The selected entry will be deleted. You can delete individual entries or all the entries (e.g. favourites or last destinations).

**Audi connect at this location\*:** Important: You must have selected a destination from the results list. This allows you to search for e.g. **travel information** in the vicinity of the selected location.

**Online traffic data\*:** The online traffic information ⇒ *page 226* can be switched on/off.

**Add destination to contact:** Refer to ⇒ *page 216*.

**Store as favourite:** Refer to ⇒ *page 216*.

**Voice guidance:** Refer to ⇒ *page 218*.

**Navigation settings:** Refer to ⇒ *page 217*.

### Note

Information on online traffic data\* can be found on the Internet at [www.audi.com](http://www.audi.com).

## Personal route assist

Applies to: vehicles with navigation system and personal route assist

*Your MMI system can memorise routes that you frequently follow and suggest them based on your vehicle's current location (e.g. the daily route to your workplace and back).*



Fig. 177 Example: Personal route display

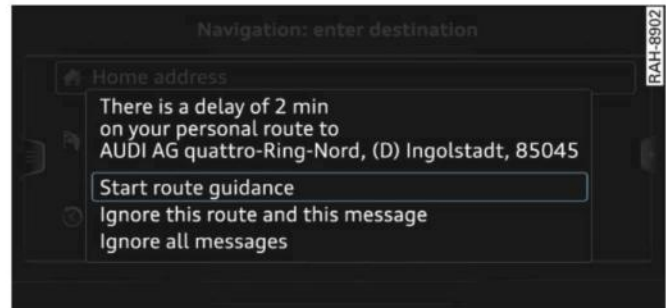



Fig. 178 Personal route tip

- ▶ Press the **NAV/MAP** button repeatedly until the **Enter destination** menu is displayed ⇒ *page 207, Fig. 172*.
- ▶ Select: right control button > **Personal route assist**.

When the function is activated , the MMI records routes you frequently follow (even if you do not enter the destinations and start route guidance).

If route guidance is not active, your personal routes are listed below the home address in the **Enter destination** menu and marked with the symbol  **1** ⇒ *Fig. 177*. This symbol is displayed in the status line on the infotainment display while the personal route assist function is switched on and the navigation menu is active. ▶

The distance to the destination and the estimated time of arrival are also displayed for your personal routes. Even before route guidance is started, your MMI system monitors the traffic situation for your personal routes and the infotainment display shows possible traffic disruptions along the route you will probably take ②  
⇒ Fig. 177.

A message is displayed if there are any larger traffic disruptions (more than 7 minutes delay), irrespective of which menu is selected ⇒ Fig. 178. Select and confirm one of the following options:

- **Start route guidance:** The MMI starts route guidance for the personal route shown and searches for a faster route (if one is available).
- **Ignore this route and this message:** The destination shown and all of the corresponding personal routes are no longer taken into account on the current trip. No more messages are displayed for the destination shown. The destination shown and all the corresponding personal routes are ignored until the car is parked and the ignition is subsequently switched on again.
- **Ignore all messages:** All of the personal routes are ignored for the current trip. No more messages are displayed. Messages for traffic disruptions on the personal routes are not displayed again until the car is parked and the ignition is subsequently switched on again.

The symbol disappears from the status line and your trips are no longer recorded as soon as you switch off the personal route assist function. Trips which have already been recorded remain stored.

#### Deleting a personal route:

- Select the desired personal route in the **Enter destination** menu ① ⇒ Fig. 177.
- Select: right control button > **Delete destination**.

#### Deleting all personal routes:

- Select: **MENU** button > **Settings** > left control button > **MMI settings** > **Factory settings**.
- Select: **Navigation and online memory** > **Restore factory settings** ⇒ page 256.

#### Note

- Personal routes are memorised depending on your vehicle's location. Routes are prioritised depending on how often you drive to a destination.
- Up to three personal routes are displayed in the **Enter destination** menu. The traffic situation is always monitored for the three routes most likely to be followed depending on your vehicle's current location.
- Please note that, once a personal route has been stored, it remains stored after the function is deactivated (i.e. it has to be deleted manually).
- This function is not available in the Mexican market.

## Home address

Applies to: vehicles with navigation system

- ▶ Press the **NAV/MAP** button repeatedly until the **Enter destination** menu is displayed  
⇒ page 207, Fig. 172.

#### Storing a home address

- Select and confirm **Home address** ②  
⇒ page 207, Fig. 172. After calling up the home address for the first time, you will be asked to set a home address.
- Select and confirm **Create now**.
- Enter a destination or select a destination from the list. **Or:**
- Select and confirm a destination > right control button > **Store as home address**.

A home address is stored in the MMI regardless of any mobile phone which may be connected. This home address is always available, even if no mobile phone is connected to the MMI.

#### Editing home address

- Select the **Home address** ② ⇒ page 207, Fig. 172.
- Select: right control button > **Edit home address**.
- Select and confirm a new destination as the home address.

The selected destination will be stored as the new home address.

## Favourites

Applies to: vehicles with navigation system

- ▶ Press the **NAV/MAP** button repeatedly until the **Enter destination** menu is displayed ⇒ page 207, Fig. 172.
- **To store a destination as a favourite:** Search for the desired destination using the entry field. **Or:** Select and confirm a destination from the list. Select: right control button > **Store as favourite**.
- **To rename a favourite:** Select the left control button > **Favourites** > *a favourite from the list* > right control button > **Rename favourite**.
- **To move a favourite:** Select *a favourite from the list* > right control button > **Move favourite**. Select and confirm the position of the favourite selected.
- **To delete a favourite:** Select *a favourite from the list* > right control button > **Delete favourite** > **Delete this favourite** or **Delete all favourites**.

## Directory contacts

Applies to: vehicles with navigation system

*Two addresses (private/business) can be stored as a destination for each contact in the directory.*

- ▶ Press the **NAV/MAP** button repeatedly until the **Enter destination** menu is displayed ⇒ page 207, Fig. 172.

### Storing a destination as a contact in the directory

Important: A mobile phone must be connected to the MMI system ⇒ page 173.

- Select a destination > right control button > **Add destination to contact**.
- Select and confirm **Add business destination** or **Add private destination**.
- Enter a name. **Or:** Select and confirm a directory contact from the list.
- Select and confirm **Store business card**.

## Alternative routes

Applies to: vehicles with navigation system



Fig. 179 Display of alternative routes on the overview map

Important: A destination must have been entered and you must have started route guidance.

- ▶ Press the **NAV/MAP** button repeatedly until the **Enter destination** menu is displayed ⇒ page 207, Fig. 172.
- ▶ Select: right control button > **Navigation settings** > **Always display alternative routes**.

Three routes will be displayed on the overview map ⇒ Fig. 179.

- ▶ Select and confirm the route which you would like to use for route guidance.

When this function is switched on , up to three suggested routes and their characteristics are displayed on the overview map ⇒ Fig. 179.

The following information (if available) is displayed in the route suggestions:

- Route type (fast ①, alternative fast ②, economical route ③)
- Distance to destination and estimated time of arrival
- Level of congestion on the route including length of delay

The route which was calculated on the basis of the selected route criteria is highlighted on the overview map. Further information on particular characteristics of your route ④ ⇒ Fig. 179 is also shown on the display and read out.

You can use the rotary pushbutton to preselect the possible alternative routes and have them displayed on the map. Select and confirm the route which you would like to use for route guidance.

## Other settings

### Navigation settings

Applies to: vehicles with navigation system

- ▶ Press the **NAV/MAP** button repeatedly until the **Enter destination** menu is displayed  
⇒ page 207, Fig. 172.
- ▶ Select: right control button > **Navigation settings**.

Depending on the function selected, you can use the following settings:

#### Display alternative routes

When this function is switched on , up to three route suggestions are displayed on the map  
⇒ page 216, *Alternative routes*.

#### Fuel warning

When the fuel gauge is in the reserve zone, a message will appear when this function is on . A list of nearby filling stations will be displayed when you confirm this message. When you select one of the filling stations, the route to its location will be calculated based on the current position of your car.

#### Trailer mode\*

Trailer mode is switched off when the vehicle leaves the factory.

When this function is switched on , the MMI will take the speed limit for vehicles towing a trailer into account and the calculated arrival time will be adjusted accordingly. Trailer mode is indicated on the map's legend menu by the symbol .

#### Personal route assist\*<sup>1)</sup>

The personal route assist function is switched off by default in the factory settings.

When this function is activated , your trips are recorded and destinations are suggested by the MMI system  
⇒ page 214.

#### Arrival notification\*

The arrival notification is switched off when the vehicle leaves the factory.

When this function is switched on , the MMI will inform you when you are approaching selected special destinations (e.g. imported myAudi special destinations). You can also have a sound played using the **Play notification tone** function.

#### Delete myAudi special destinations\*<sup>1)</sup>

Destinations that you import from your myAudi account to your MMI are automatically saved. You can delete them individually or all at once.

#### Presentation mode

Use the **Presentation mode** to plan and "drive" a journey effectively without the need to move the vehicle. You can choose your start location manually (**Select start location**) if, for example, you would like to calculate a route starting from a different position than the current position of the vehicle. Start the **Presentation mode** to simulate a route guidance.

### Route criteria

Applies to: vehicles with navigation system



Fig. 180 Possible route criteria

- ▶ Press the **NAV/MAP** button repeatedly until the **Enter destination** menu is displayed  
⇒ page 207, Fig. 172.
- ▶ Select: right control button > **Route criteria**.

#### ① Traffic avoidance<sup>1)</sup>

<sup>1)</sup> This function is not available in the Mexican market.

- **automatic:** The route is automatically optimised using the current traffic information. If the MMI system does not display a detour route although the automatic traffic avoidance function is on and a traffic jam has been reported on the planned route, this is because the estimated time required for the detour is longer than the delay on the route with the traffic jam.
- **manual:** The MMI indicates that a better route is available and informs you of the potential time saving ⇒ *page 226*. You can then choose which route you would like to use.
- **off:** The route is not updated automatically. No optimised route is suggested.

② **Motorways**/ ③ **Vignette roads**<sup>1)</sup>/ ④ **Toll roads**/ ⑤ **Ferries**<sup>1)</sup>/ ⑥ **Motorail**<sup>1)</sup>: If you do not wish for the navigation system to include motorways, vignette/toll roads, ferries or car trains when calculating the route, you can select the option **avoid**.

### ⑦ **Time restricted**

- **avoid:** Roads that are closed at certain times of the day (e.g. pedestrian zones) are excluded from the route calculation.
- **automatic:** The MMI system determines whether the restricted road can be included in the route calculation based on the time tables currently stored in the navigation data.
- **with:** Roads that are closed at certain times of the day are included in the route calculation.

### ⑧ **Seasonally restricted**<sup>1)</sup>

- **avoid:** Roads that are closed seasonally (e.g. mountain passes) are excluded from the route calculation.
- **automatic:** The MMI system determines whether the seasonally restricted road can be included in the route calculation based on the time tables currently stored in the navigation data.
- **with:** Roads that are closed seasonally are included in the route calculation.

## Voice guidance

Applies to: vehicles with navigation system

- ▶ Press the **NAV/MAP** button repeatedly until the **Enter destination** menu is displayed ⇒ *page 207, Fig. 172*.
- ▶ Select: right control button > **Voice guidance**.

**Voice guidance:** The navigation cues can be played in **complete** or **compact** form. You can use the **traffic** option to have the system play only those announcements on traffic obstructions that are relevant for your route. Select **off** if you do not want the system to play any navigation cues.

**Voice guidance during calls:** Navigation cues during a telephone call can be switched on/off.

**Entertainment fader:** Refer to ⇒ *page 261*.

**Volume of spoken cues:** You can change the volume of a spoken cue while it is being played using the ON/OFF button ⇒ *page 152*. Further information can be found on ⇒ *page 261*.

<sup>1)</sup> This function is not available in the Mexican market.

## Map

### How to use the map

Applies to: vehicles with navigation system



Fig. 181 Example: Standard map with crosshairs switched off



Fig. 182 Example: Standard map with crosshairs switched on

- Press the **NAV/MAP** button repeatedly until the map is displayed ⇒ Fig. 181.

### Zooming in/out on map

- Turn the rotary pushbutton clockwise or anti-clockwise. You can also zoom in or out on the map using the MMI touch pad\* ⇒ page 157. Or: Scroll the left thumbwheel on the multi-function steering wheel\* ⇒ page 16.

### Switching the crosshairs on/off

- **To switch on the crosshairs:** Press the rotary pushbutton while the map is displayed ⇒ Fig. 181.
- **To switch off the crosshairs:** Press the **BACK** button.

**With the crosshairs switched off** ⇒ Fig. 181:

- ① **Orientation:** The map is displayed either in the **2D north** or the **2D driving position** perspective.

- ② Distance to the destination
- ③ When the **trailer mode** function is switched on , a corresponding symbol is shown next to the arrival time.
- ④ **Scale:** Turn the rotary pushbutton clockwise/anti-clockwise to zoom in or out. When the **Automatic zoom** function is switched on , an “A” for “automatic” is shown in the zoom symbol.
- ⑤ Altitude
- ⑥ Location of the vehicle
- ⑦ **Route information:** Various information is displayed during route guidance (e.g. the upcoming manoeuvre including the calculated distance and road name). Traffic information or special destinations on your current route are also displayed.
- ⑧ Road the vehicle is currently on. When the vehicle is stationary, “offroad” is displayed here.

**With the crosshairs switched on** ⇒ Fig. 182:

- ⑨ **The crosshairs:** Move the crosshairs in the desired direction using the MMI touch pad\*/rotary pushbutton and select an item on the map as the destination. Alternatively, have information displayed on the map item.
- ⑩ **Speed display<sup>1)</sup>:** Display of the maximum speed limit on motorways, dual carriageways and other major roads.
- ⑪ **Entertainment drawer\*:** Refer to ⇒ page 157.
- ⑫ **Additional information on the position of the crosshairs:** If you move the crosshairs onto a point on the map, any existing information on the current position of the crosshairs will be displayed. Press the rotary pushbutton to call up the destination details or start route guidance. If the crosshairs are switched off, the road you are currently on will be displayed.
- ⑬ **Map content** (special destinations, favourites). If several special destinations are located close to each other, their symbols are stacked on the map. ►

1) Applies to vehicles without camera-based speed limit display only

- 14 Better route : If a better route is available for the current route guidance, this will be shown on the map together with the time saved. Further information can be found from ⇒ *page 226* onwards.

### Note

Whether the level of congestion is taken into account when the route is being calculated depends on your traffic avoidance settings ⇒ *page 217*.

### Map functions

Applies to: vehicles with navigation system

- ▶ Press the **NAV/MAP** button repeatedly until the map is displayed ⇒ *page 219, Fig. 181*.
- ▶ Press the left control button.

The following map functions are available:

#### Switch to destination entry

The search function must be displayed in the **Enter destination** menu ⇒ *page 207, Fig. 172*.

#### Traffic announcements

Up-to-date traffic information is shown on the infotainment display. Further information can be found from ⇒ *page 225* onwards.

#### Route list

The route list can only be displayed when the route guidance function is active; it contains information on the route, road names and the length of the route sections. On motorways, potential parking areas and service stations will be displayed. You can select them as e.g. a stopover.

#### Special destinations along the route

Important: The route guidance function must be active.

You can search for special destinations along your current route. For more information, please refer to ⇒ *page 211*.

### Further options on the map

Applies to: vehicles with navigation system

- ▶ Press the **NAV/MAP** button repeatedly until the map is displayed ⇒ *page 219, Fig. 181*.
- ▶ Press the right control button.

Depending on the function chosen, the following additional options may be available in the **Map** menu:

**Stop route guidance:** Refer to ⇒ *page 213*

**Adjust position:** You can adjust the vehicle's position on the map manually and thus change the route.

**Map settings:** Refer to ⇒ *page 221*.

**Route criteria:** Refer to ⇒ *page 217*.

**Voice guidance:** Refer to ⇒ *page 218*.

**Navigation settings:** Refer to ⇒ *page 217*.

**Always display alternative routes:** Refer to ⇒ *page 216*.

**Parking in vicinity of route\*:** Parking facilities near the vehicle are displayed.

**Store current position\*:** You can store your vehicle's current position as a favourite ⇒ *page 216* or as a contact in the directory ⇒ *page 216*.

**Audi connect at this location\*:** Enables you to search for e.g. **Travel information** in the location entered (events, weather at destination etc.).

**Online traffic data\*:** You can switch the online traffic data on or off .

**Country information:** Refer to ⇒ *page 213*.

**Exclude route\*:** When route guidance is activated, a section of the calculated route that you have set (max 20 km) will be avoided if possible. The navigation system will calculate an alternative route. The route you entered will only be blocked in the current route guidance; if required, you will need to re-enter the route you wish to avoid. If you exclude a route section, this section will be hatched in red and white on the map. ▶



**Adjust route\*:** Move your finger over the MMI touch pad\*/rotary pushbutton to adjust the route on the overview map.

### Map settings

Applies to: vehicles with navigation system

- ▶ Press the **NAV/MAP** button repeatedly until the map is displayed.
- ▶ Select: right control button > **Map settings**.

Depending on the function selected, you can use the following settings:

#### Map colours

**day/night:** The map is displayed with a light/dark background colour.

**automatic:** The colour of the map changes to match the current light conditions (e.g. from **day** to **night** when driving through tunnels).

#### Map display

**Standard:** Refer to ⇒ *page 219, Fig. 182*.

**Google Earth\*:** Refer to ⇒ *page 222, Fig. 183*.

**Traffic\*<sup>1)</sup>:** Refer to ⇒ *page 225, Fig. 187*.

#### Map orientation

**destination:** The map indicates the destination and is set to face north.

**2D driving position/2D north map:** The map depicts the vehicle's current position. The map is set to face the direction of travel or north.

**3D driving position\*:** The current vehicle position is displayed in a three-dimensional map, and the map is set to face the direction of travel. If the map scale is more than 100 km, the map is set to face north.

**overview:** The entire route from the vehicle position to the final destination or next stopover is displayed on the map. The map scale varies according to the length of the route and is adapted automatically. The map is set to face north.

#### Route information

The display of route information such as the street you are currently on, upcoming turn-offs, traffic information or special destinations on the current route can be switched on/off.

#### Automatic zoom

**on:** The map scale is adjusted automatically according to the category of the road you are on (motorway, major road, other road) to ensure that you always have the best possible overview of the route ahead. When there is an upcoming turn-off, the map display will also be automatically adjusted so that you have a more detailed view.

**intersection:** When route guidance is active and there are upcoming turn-offs, the map display will temporarily switch to a more detailed scale so that the road layout can be identified more easily.

**off:** The map scale you have set will remain unaltered.

#### Map content

The display of map content such as weather information, traffic information or favourite destinations can be switched on and off.

The weather\* is shown on the map if the scale is set to 5 km or more ⇒ *page 216, Fig. 179*.

<sup>1)</sup> This function is not available in the Mexican market.

## Google Earth map display

Applies to: vehicles with navigation system and Audi connect (infotainment)

You can have the map display satellite images using the Google Earth map display.



Fig. 183 Example: Google Earth map display



Fig. 184 Example: Google Earth map display with Google Street View

Important: The requirements for Audi connect (infotainment) must be met ⇒ *page 191*.

- ▶ Press the **NAV/MAP** button repeatedly until the map is displayed.
- ▶ Select: right control button > **Map settings** > **Map display** > **Google Earth**.

For this map display the system uses data packets received online in the form of satellite pictures and combines these pictures with the road network from the **Standard** map display. The MMI has 2 GB of flash memory for temporarily storing the map/navigation data received online (corresponds to map/navigation data for about 4000 km of route guidance). You can also use the loaded satellite pictures for route guidance without an active data connection as long as these pictures are stored.

### Google Street View

With Google Street View, you can explore many locations all over the world virtually from the

perspective of a pedestrian. Google Street View is available as soon as the symbol ① ⇒ *Fig. 183* is shown in crosshairs mode.

**To start Google Street View:** Turn the rotary pushbutton to select a scale below 30 m.

The following options are available:

- **To explore a destination step-by-step:** Press the rotary pushbutton when the symbol ② ⇒ *Fig. 184* is visible.
- **To zoom in/out of the current display (up to 4x):** Turn the rotary pushbutton to the left/right ③ ⇒ *Fig. 184*.
- **To navigate in the street view:** Move your finger in the desired direction on the MMI touch pad\* or move the rotary pushbutton in the desired direction.

### Additional information

In the **Map content** menu ⇒ *page 221*, you can activate the function to show additional information on the infotainment display. To show the additional information move the crosshairs onto an item on the map and press the rotary pushbutton.

#### **i** Note

- You can delete the data stored by the Google Earth map display by selecting **Factory settings** > **Navigation and online memory** ⇒ *page 256*.
- Google Earth is an Audi connect infotainment service that is updated at regular intervals when it is called up. This can take a few seconds.
- When the Google Earth 3D map display is switched on, the map display automatically switches to the 2D map while you are driving through a tunnel.
- For safety reasons, the Google Street View functions cannot be used while the vehicle is moving.
- Please always note the information in the chapter ⇒ *page 204, General notes on Audi connect (infotainment)*.
- Further information can be found on the Internet at **www.audi.com**.

## Map update

### Introduction

Applies to: vehicles with navigation system

There are several different ways of updating the map:

- Map updates via the **online map update\*** function ⇒ *page 223*.
- Map updates via the **online map update\*** function ⇒ *page 223* <sup>1)</sup>.
- Importing a map update to your MMI using an **SD card\*** <sup>1)</sup>. Further information can be found on the Internet at **my.audi.com**.
- Map update at your Audi dealer, who may charge for this service.

### Online map update

Applies to: vehicles with navigation system and Audi connect (infotainment)

*With the online map update function you can update the map material of your navigation system directly in the vehicle.*

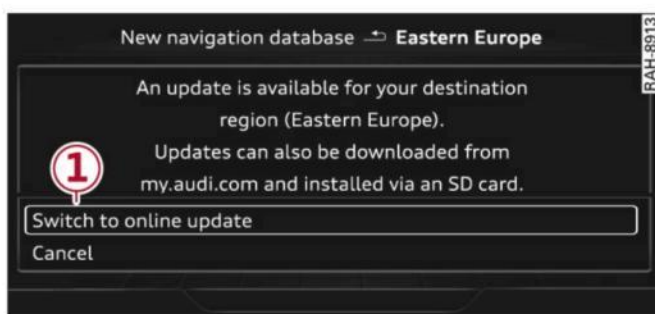

Fig. 185 Example: Display of a new online map update

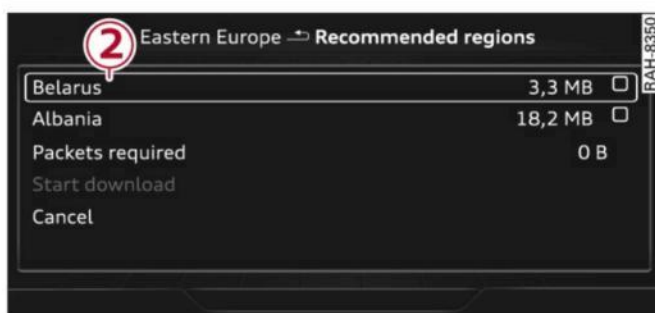

Fig. 186 Example: Selection of a country package

**Important:**

The requirements for Audi connect infotainment services must be met ⇒ *page 191*.

You must have a myAudi account and have added your vehicle to it.

The MMI uses the vehicle's position to establish which regions you are most often in. The MMI uses this information to suggest update packages for these regions if any are available

⇒ *Fig. 185*.

- ▶ Select and confirm **1 Switch to online update** ⇒ *Fig. 185* when the message informing you of a new map update appears on the infotainment display. **Or:**
- ▶ Select: **MENU** button > **Settings** > left control button > **System maintenance** > **System update** > **Online update**.

A list of the available update packages is shown on the infotainment display ⇒ *Fig. 186*.

### Selecting online map update

- Select an update package from the list (☑). If update packages with a large volume of data are available for certain countries (e.g. France), you can choose to update individual regions (e.g. only southern France).
- Press the **BACK** button to confirm your selection and return the list of available update packages.

### Starting download

- Select and confirm **Start download**.
- Confirm the safety query by selecting **Start download** again.

The update packages will be downloaded, and the download status will be shown on the infotainment display.

### Installing online map update

The installation of the downloaded maps only occurs after the vehicle has been parked. The new update packages are installed after the ignition is switched off. When you restart the MMI, a message indicating that the updates have been installed successfully will appear on the infotainment display.

- Confirm the successful update with **OK**. ▶

<sup>1)</sup> This function is not available in the Mexican market.

The new maps can now be used for navigation.

### CAUTION

If you cancel a map update download, the data already downloaded is permanently deleted. The appropriate update package can be downloaded again by selecting the **MENU** button > **Settings** > left control button > **System maintenance** > **System update**.

### Note

- Please always note the information in the chapter ⇒ *page 191, Audi connect (infotainment)*.
- Because of the high level of data usage when downloading large country update packages or the entire package, we recommend that in these cases you download the data on your computer from your myAudi account, save them on an SD card and then import them to your MMI system. Further information can be found on the Internet at **my.audi.com**.
- Please always note the information in the chapter ⇒ *page 204, General notes on Audi connect (infotainment)*.

## myAudi special destinations

### Introduction

Applies to: vehicles with navigation system

You can import your myAudi special destinations in two ways:

- Importing myAudi special destinations via the **online update\*** ⇒ *page 224*.
- Importing myAudi special destinations to the MMI using an **SD card**. Further information can be found on the Internet at **my.audi.com**.

### Note

This function is not available in the Mexican market.

### myAudi special destinations (online update)

Applies to: vehicles with navigation system and Audi connect (infotainment)

*You can download your myAudi special destinations from your myAudi account while in the vehicle and use them for route guidance.*

Important:

You must have a myAudi account and have stored myAudi special destinations.

You must have already sent myAudi special destinations from myAudi to your vehicle.

- ▶ Select: **NAV/MAP** button > left control button > **Special destinations** > **myAudi special destinations**.
- ▶ If you have already imported myAudi special destinations, select the right control button > **Import myAudi special destinations**.
- ▶ Log in with your myAudi user data/myAudi PIN if necessary. The update sources available will be listed on the infotainment display.
- ▶ Select and confirm **Online update**.

### Selecting myAudi special destinations to import

- Select all the myAudi special destinations desired from the list (✓).
- Select and confirm **Start download**.

### Starting download

The size of the myAudi special destinations selected is shown on the infotainment display.

- Confirm the download again by selecting **Start download**.

The myAudi special destinations will be downloaded, and the download status will be shown on the infotainment display.

- To finish importing the new myAudi special destinations, confirm the update by selecting **OK**.

## Activating myAudi special destinations in the map view

The myAudi special destinations must now be activated in the map display so that they can be used for the navigation system.

- Select: **NAV/MAP** button > right control button > **Map settings** > **Map content**. The imported myAudi special destinations are listed and can be identified by the list names you assigned to them.
- Select all myAudi special destinations that you would like to be shown in the map display.
- Press the **BACK** button.

The selected myAudi special destinations are now displayed in the map view and can be used for route guidance.

### **i** Note

Please always note the information in the chapter ⇒ *page 204, General notes on Audi connect (infotainment)*.

## Calling up traffic information

### Dynamic traffic avoidance

Applies to: vehicles with navigation system

Using the traffic information received via TMC/TMCpro\*/online - depending on availability - you can have the MMI guide you past traffic obstructions whenever possible. For this, the traffic avoidance must be switched on ⇒ *page 217*.

### **i** Note

The "Traffic information" function is not available for the markets of the Gulf Cooperation Council (GCC) member states or for the Mexican market.

### Traffic information (TMC/TMCpro\*)

Applies to: vehicles with navigation system

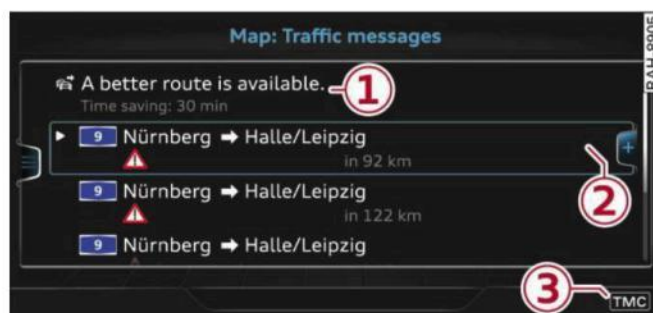

Fig. 187 View of traffic messages with better route

- ▶ Press the **NAV/MAP** button repeatedly until the map is displayed.
- ▶ Select: left control button > **Traffic messages**.

An overview of all the traffic messages will be shown on the infotainment display ⇒ *Fig. 187*. The traffic messages are sorted according to road name. If there are several traffic messages for one road, an arrow is displayed next to the road name in the corresponding line (2 ▶). Press the rotary pushbutton to have all the traffic messages for the road displayed.

When route guidance is started, traffic obstructions relevant for your route are shown in the top section of the list in order of the distance from your current location.

If your MMI has calculated a better route for the current route guidance, a corresponding message is shown (1) ⇒ *Fig. 187*. Further information can be found on ⇒ *page 226*.

### Displaying traffic information on the map

The following coloured markings indicate the traffic flow along your planned route:

- **Green**: no obstructions
- **Orange**: slow-moving traffic
- **Red**: traffic jam

Traffic jams or other obstructions are marked with a coloured warning symbol on the map when route guidance is active. Hatched markings show the stretch of road affected by the traffic obstruction. Traffic obstructions marked with grey warning symbols are not on your planned route.

All traffic jams or other obstructions are marked with a coloured warning symbol on the map when route guidance is not active.

You can adjust the settings for the display of the coloured markings, warning symbols etc. in the **Map content** menu ⇒ *page 221*.

Reception of traffic information is also indicated by the **TMC/TMCpro**\*/**ONLINE**\* symbol in the status line of the infotainment display ③ ⇒ *Fig. 187*.

### Note

- Urgent traffic information, such as a car travelling in the wrong direction on the motorway, is displayed automatically. To hide the traffic information, press the **BACK** button or the rotary pushbutton.
- The "Traffic information" function is not available for the markets of the Gulf Cooperation Council (GCC) member states or for the Mexican market.

### Better route

Applies to: vehicles with navigation system

*By receiving traffic information via TMC, your MMI calculates a better route (if one is available) and any possible time saving for the current route guidance. You can then choose which route you would like to use.*

- ▶ Press the **NAV/MAP** button repeatedly until the map is displayed.

Important: The route guidance function must be active.

Dynamic traffic avoidance must be set to **manual** ⇒ *page 217* and the map must be displayed.

If your MMI has calculated a better route for the current route guidance, the message **A better route is available**. and the time saving will be displayed on the map. In the map view, the  symbol ⇒ *page 219, Fig. 182* draws your attention to a better route.

### Using a better route

- Press the rotary pushbutton. **Or**: Select the left control button > **Traffic messages**. The better route will be displayed along with your calculated arrival time.
- Select and confirm the better route.
- The better route will be used for the continuing route guidance.

### Online traffic information

Applies to: vehicles with navigation system and Audi connect (infotainment)

*The MMI system can receive real-time information from the Internet regarding traffic congestion, accidents, roadworks and other incidents.*

Important: The requirements for Audi connect (infotainment) must be met ⇒ *page 191*.

- ▶ Press the **NAV/MAP** button repeatedly until the map is displayed.
- ▶ Select: right control button > **Online traffic data on** (✓).

- **To switch on the traffic map display**: To have the traffic information displayed in the best possible way, select the **NAV/MAP** button > right control button > **Map settings** > **Map display** > **Traffic**.

You can also have the traffic information displayed on the Google Earth map ⇒ *page 222* or the standard map ⇒ *page 219, Fig. 181*.

If **online traffic information** cannot be received, the traffic information will automatically be received via **TMC/TMCpro**\* ⇒ *page 225*.

### Prayer compass\*<sup>1)</sup>

Applies to: vehicles with prayer compass

Important: The display must be set to the map view ⇒ *page 219*.

- Select: left control button > **Mecca**. The direction of prayer in relation to the current vehicle position will then be shown on the infotainment display. ▶

<sup>1)</sup> This function is only available for the markets of the Gulf Cooperation Council (GCC) member states.

**i Note**

- Please always note the information in the chapter ⇒ *page 204, General notes on Audi connect (infotainment)*.
- Every vehicle with active **Online traffic data** contributes to specifying and predicting the traffic situation as precisely as possible. For this purpose, information on the position of

- your vehicle is encrypted and transmitted anonymously to the traffic data providers at regular intervals. Should you not wish this to happen, you can switch off the **online traffic information** function at any time.
- The **online traffic information** network is not yet available in all countries or areas. Further information can be found on the Internet at [www.audi.com](http://www.audi.com).

## Troubleshooting

Applies to: vehicles with navigation system

| Subject  | Advice  |
|--|---|
| <b>Search function:</b> The desired destination cannot be found. | The destination may not be stored in the navigation database. <b>Or:</b> Check that you have spelt the search term correctly and that the desired country has been selected for the search function via the <b>Country selection</b> option ⇒ <i>page 213</i> . |

## Radio

### Calling up the radio menu

The radio supports the following wavebands: FM, AM, DAB\* (digital radio). You can use the HD Radio receiver\* to receive radio stations from the FM/AM wavebands digitally.



Fig. 188 FM/DAB station list

► Press the **RADIO** button.

After you call up the radio, the station list that was last open will be displayed.

**To select a station:** Select a station from the station list and confirm it.

**To set a waveband:** Press the **RADIO** button repeatedly until the desired waveband appears.

The following information is displayed in the FM/DAB\* station list ⇒ Fig. 188:

#### ① Waveband

The current waveband of the station is shown in the FM/DAB\* or DAB\* station list and in the favourites list.

#### ② Radio text (short display)

Programme information for the currently selected station is displayed in all station lists when available.

#### ③ Frozen station name (FM)<sup>1)</sup>

Station names with this symbol have been stored permanently. Refer to ⇒ page 230, *Station names*.

#### **i** Note

- The DAB\* waveband is not available in all countries.
- The DAB\* waveband also supports the transmission standards DAB+\* and DMB Audio\*, where available.
- The DAB\* waveband is not available in the Mexican market.
- **HD Radio** is only available in the Mexican market.

## Radio functions

### Search function

Applies to: vehicles with search function

You can enter search terms in any order using the search function. You can search in all wavebands by station name or programme type (e.g. **News**).

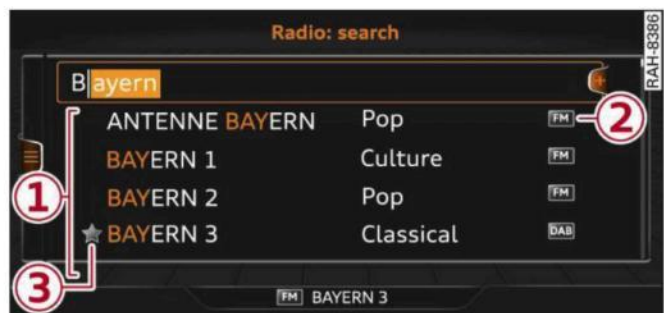

Fig. 189 Entry field and results list for the search function

– **To call up the search function:** While in a station list (e.g. FM station list), turn the rotary pushbutton to the left until the entry field for the **search** function is displayed.

– **To use the search function:** Refer to ⇒ page 160, *Search function*.

You can also search for frequencies<sup>2)</sup>.

Stations from the favourites ③ are displayed in the results list ① ⇒ Fig. 189. The symbol ② shows which station list you will switch to by selecting a particular station.

1) This function is not available in the Mexican market.

2) This function is not available for DAB\* waveband.



## Further options

- ▶ Select: **RADIO** button > right control button.

The following options may be available to you depending on the waveband:

- **Sound settings:** Refer to ⇒ *page 260*.
- **Store as favourite:** Refer to ⇒ *page 231, Favourites*.
- **Tag this song for iTunes\*:**<sup>1)2)</sup> Connect your Apple device to the Audi music interface\*. Select and confirm **Tag this song for iTunes**. The track that is currently playing will be copied to your Apple device. Synchronise your Apple device with iTunes. The next time you call up your iTunes library, the tagged tracks will be displayed. If no Apple device is connected, the tagged tracks will be stored temporarily on the MMI system (max. 50 tracks). As soon as you connect your Apple device to the Audi music interface, the tags will be imported to the device.
- **Programme guide\*:**<sup>3)</sup> The current and next radio programmes are listed in the digital **programme guide\*** for all supported stations. Select and confirm a radio programme to have more details on the programme displayed.
- **Manual station search:**<sup>4)</sup> The frequency bar is displayed. Select and confirm the desired frequency.
- **Seek:**<sup>5)</sup> The previous/next receivable frequency will be set.
- **Radio settings:** Refer to ⇒ *page 231*.

## Announcements

- ▶ Select: **RADIO** button > right control button > **Announcements**.

### Traffic announcements\*:<sup>6)</sup>

- **off:** Traffic announcements are not played.

- **FM:** Traffic announcements can be received via **FM** and played by the system irrespective of the selected waveband.
- **FM/DAB\*:** You receive traffic announcements from both wavebands. If DAB traffic announcements are not available from the station currently set, they will be received from the FM waveband.

### DAB announcements\*:<sup>6)</sup>

Depending on station availability, information (e.g. news, weather information) may be played when the function  is switched on.

### Volume of announcements:<sup>6)</sup>

Refer to ⇒ *page 261*.

## Radio text

- ▶ Select: **RADIO** button > left control button > a waveband (e.g. **FM**) > a station.
- ▶ Select: right control button > **Radio text**.

Additional information on the programme (e.g. artist, composer, track) is shown.

**To browse radio text entries:** Turn the rotary pushbutton clockwise or anti-clockwise.

Important: A radio text entry must be displayed, and the station must be transmitting a telephone number, navigation destination or a text message number as Radio Text Plus information.

If a location, telephone number or text message number has been stored for a radio text entry, the entry will be displayed with a coloured frame. The following options are available:

### Call\*/Start route guidance\*/Write text message\*:

- Select a radio text entry with Radio Text Plus information and press the rotary pushbutton. ▶

1) This function is only available in the Mexican market.

2) Still under development at the time of print.

3) Not in the FM, AM station lists

4) Not in the DAB\* waveband or in the mixed FM/DAB\* station list.

5) Not in the mixed station list FM/DAB\*

6) This function is not available in the Mexican market.

- Select and confirm **Call\*/Start route guidance\*/Write text message\***. **Or:** Press the **[BACK]** button to cancel the process.

### **i** Note

The availability of radio text and Radio Text Plus depends on the radio station.

### Station names

- ▶ Select: **[RADIO]** button > left control button > **FM**. Select the desired station from the station list.

### Variable station names:

Some stations use variable station names. Depending on how the station names are sorted, the position of a variable station name may change in the station list. You can lock the current name of a selected station permanently by selecting the **Lock station name**<sup>1)</sup> option.

- **Lock station name:** Select the right control button > **Confirm**. The locked station name will be marked with the symbol **③** ⇒ *page 228*, *Fig. 188*.
- **Unlock station name:** Select the right control button > **Unlock station name**. The name received for the radio station will be displayed.

### Detailed station information view



**Fig. 190** Radio view: Detailed station information

Important: The system must be tuned to a radio station. The **detailed station information** option must be switched on ⇒ *page 232*.

Symbols in the detailed station information view ⇒ *Fig. 190*:

#### **①** Radio text availability

**Radio text** is available for the current station. Refer to ⇒ *page 229*.

#### **②** Slide show availability<sup>1)</sup>

A **slide show** is available for the current station.

#### **③** Interference (DAB\*, FM HD Radio\*)

The station cannot be received.

#### **④** Picture view

You can choose to display a **slide show**<sup>1)</sup>, **cover art**<sup>1)</sup> or the **station logo**<sup>2)</sup>. Refer to ⇒ *page 232*, **Preferred image\*** (DAB\*, HD Radio waveband, FM).

### Displaying the station list:

Turn the rotary pushbutton. **Or:** Press the **[BACK]** button.

## Radio menu



**Fig. 191** Example: Radio menu

- ▶ Select: **[RADIO]** button > left control button.

**To set the waveband:** Select and confirm the waveband you require in the radio menu ⇒ *Fig. 191*. **Or:** Press the **[RADIO]** button repeatedly until the desired waveband appears. The station list will be displayed. ▶

1) This function is not available in the Mexican market.

2) Station logos may not be available in all countries.

## ① Favourites

The favourites list will be displayed. The menu item **Favourites** appears if at least one radio station has been stored as a favourite. Refer to ⇒ page 231, *Favourites*.

## ② FM/DAB\*

The mixed FM/DAB station list\* appears when DAB\* is available. Refer to ⇒ page 228, *Calling up the radio menu*.

## Other wavebands

Depending on the vehicle's equipment, you may be able to select other wavebands ③/④/⑤ ⇒ Fig. 191 in the selection menu.

## Favourites

*You can store your favourite stations from any waveband in the favourites list.*

► Press the **RADIO** button.

Important: You must be in a station list.

- **To store a favourite:** Select a station from the list > right control button > **Store as favourite**.  
**Or:** Press and hold the rotary pushbutton for several seconds.

Important: At least one favourite must be stored in the favourites list.

- **To display the favourites list:** Select the **RADIO** button > **Favourites**.

Important: The favourites list must be displayed.

- **To listen to a favourite:** Select and confirm a favourite from the list.
- **To move a favourite:** Select a favourite from the list > right control button > **Move favourite**.  
**Or:** Press and hold the rotary pushbutton for several seconds. Select and confirm the position of the favourite selected.
- **To delete a favourite:** Select a favourite from the list > right control button > **Delete favourite** > **Delete this favourite** or **Delete all favourites**.

## Other settings

### Radio settings

► Select: **RADIO** button > right control button > **Radio settings**.

Depending on the waveband setting, you can select the following options:

### Alternative frequency\* (FM, DAB\*)<sup>1)</sup>

**on:** The tuner attempts to switch to an alternative frequency of the current station when the reception quality becomes weaker. When the reception is lost in the FM or DAB\* waveband, the system will automatically (in the background) switch to an alternative station, if there is one available.

**off:** Switching to an alternative frequency is switched off. The current frequency will be maintained, and in some cases may no longer be received. In the FM waveband, the alternative frequency function is automatically switched on again when the station is changed.

### Switch regional stations\* (FM, DAB\*)<sup>1)</sup>

Important: The Alternative frequency function must be switched on.

Some stations divide up their programming by region and provide different content to different regions. When the function is on , the system switches to related regional stations if the current station has poor reception.

### L band (DAB\*)<sup>1)</sup>

There are two wavebands for the digital radio: Band III and L band. Ensembles in the band III usually have a larger range extending into several regions. They can be received at all times. In some regions DAB is broadcast in the L band. When this option is on, stations from the L band will also be received.

### Station names (FM)<sup>2)</sup>

**scrolling:** Scroll texts transmitted by FM stations will appear on the infotainment display. ►

<sup>1)</sup> This function is not available in the Mexican market.

<sup>2)</sup> This function is only available in the Mexican market.

**fixed:** Scroll texts transmitted by FM stations will not appear in the infotainment display. The current scroll text on the display will freeze.

### FM/AM HD Radio<sup>1)</sup>

You can switch the reception of HD Radio on or off.

### Station sorting (FM)<sup>2)</sup>

**A-Z:** The stations are displayed in the station list in alphabetical order. Radio stations with variable station names are displayed after the stations which have been sorted alphabetically. Radio stations with a frequency as their station name are displayed at the end of the list.

**ID:** The stations in the station list are sorted according to the station's ID (e.g. all BBC radio stations are sorted together). Radio stations with a frequency as their station name are displayed at the end of the list.

### Station sorting (DAB\*)<sup>2)</sup>

**A-Z:** The stations are displayed in the station list in alphabetical order.

**Ensemble:** Ensembles comprise various radio stations of a specific area (e.g. a town or region); they are listed together as an ensemble in the station list. To open/close the list of radio stations in an ensemble, select and confirm the ensemble. Available sub-programmes\* (additional services provided by DAB\* radio stations) are listed beneath the radio station (indented).

### Detailed station information

When this function is switched on  and the station or favourites list is open, the system switches to the **Detailed station information** view ⇒ *page 230* after approximately five seconds. Where available, information on the selected station (e.g. station name, artist, slide show, station logo<sup>3)</sup>) may be shown.

### Preferred image\* (DAB\*, HD Radio waveband<sup>1)</sup>, FM)

You can specify your preferred image for the **Detailed station information** option ⇒ *page 230*.

- **station logo**<sup>3)</sup>: The station logo is displayed if available.
- **cover art:** Album covers are displayed if available.
- **slide show**:<sup>2)</sup> Depending on availability, additional information as a supplement to the normal programme may be shown (e.g. images from the studio, current photographs of artists or album covers).

### Update station list\* (AM, DAB\*<sup>2)</sup>)

The station list will be updated.

### Gracenote online database\*

Important: The MMI must be connected to the Internet. The **cover art** option must be selected ⇒ *page 232*, **Preferred image\*** (DAB\*, HD Radio waveband, FM).

When this function is switched on , album covers or genre artwork will, if available, be downloaded from the Gracenote online database for the track currently playing.

### Region for station logos\*<sup>3)</sup>

We recommend using the setting **automatic**. When driving abroad, or if the station logo is not displayed correctly, select and confirm the appropriate region.

Applies to journeys in Russia: Select and confirm the city in Russia from the list which is the nearest distance to your vehicle's current location.

#### Note

- If the **Traffic announcements** or **DAB announcements\*** function is switched on, playback is interrupted for announcements. You can cancel an announcement while it is

1) This function is only available in the Mexican market.

2) This function is not available in the Mexican market.

3) Station logos may not be available in all countries.

being played by briefly pressing the ON/OFF button ① ⇒ *page 152, Fig. 141.*

– Not all radio settings for the FM and DAB\* wavebands are available in the mixed station list FM/DAB\*.

## Troubleshooting

| Subject  | Advice  |
|--|---|
| A station with poor reception is no longer listed in the station list after you switch to another station. | Store the station as a favourite in advance and call it up via the favourites list ⇒ <i>page 231.</i> |

## Media

### Introduction

The MMI system includes various media drives and provides various options for connecting devices. For example, you can play audio/video\* files from the jukebox\* or connect mobile devices to the Audi music interface\* and operate it via the MMI.

### Notes

#### General information

**Media and format limitations:** The MMI system (including the SD card reader and the connection for the USB mass storage device\*) has been tested for use with many of the products and media currently available on the market. However, there may be some devices/media and audio/video\* files that are not supported or cannot be played, or the functionality may be limited under certain circumstances.

**Digital rights management:** Please note that copyright law applies to audio/video\* files.

The MMI media drives do not support DRM-protected files; these files are marked with the symbol .

**Data storage:** Never store important data on SD cards, the jukebox\*, CDs/DVDs or mobile devices. AUDI AG shall not accept any liability whatsoever for the loss of files and media.

**Loading times:** The more files, folders or playlists are stored on a storage device, the longer it will take to load the audio files/video\* files. We recommend using a storage device which contains only audio/video\* files. If you want to reduce the time it takes to load the audio/video\* files, you can create subfolders (e.g. for an artist or album). The loading time will be extended additionally if you are importing data.

**Metadata:** Metadata stored on audio files (e.g. artists, tracks, album covers) will be displayed automatically when the files are played. If this information is not stored on the relevant medium, the MMI system will use the database of

metadata from Gracenote. Nevertheless, metadata may not be displayed in some cases.

**Restricted performance:** If you experience restricted performance, reset the **Media settings** to the factory defaults ⇒ *page 256*.

If you experience restricted performance from the **Jukebox\***, reset it to the factory settings ⇒ *page 256*.

For information on the characteristics of the supported media and file formats, please refer to ⇒ *page 249 onwards*.

#### CAUTION

Please always observe the information ⇒  in *Wi-Fi hotspot on page 202*.

#### CD/DVD mode

**CD/DVD and format limitations:** In view of the variety of CDs/DVDs and the difference in memory capacities, the functionality may be restricted in the case of some storage devices. Under certain circumstances, audio CDs/video DVDs that are copy-protected or CDs/DVDs that do not comply with the standard audio format, and multi-session CDs cannot be played at all, or the functionality may be limited. We recommend always finalising the burning process when creating multisession CDs. Multisession is not supported for DVDs.

**Handling CDs/DVDs, the CD drive or the DVD drive:** To ensure perfect, high-quality playback and avoid scanning errors or damage to the media drive, always store CDs/DVDs in a suitable case and do not expose them to direct sunlight. Do *not* use:

- Damaged, dirty or scratched CDs/DVDs
- Single CDs/DVDs (diameter 8 cm)
- Non-circular CDs/DVDs (shape CDs)
- CDs/DVDs with stickers
- Protective rings
- Cleaning discs

**Thermal cut-out:** In the case of unusually hot or cold outside temperatures, it is possible that CD/DVD playback will temporarily not be possible. A ►

thermal cut-out is installed to protect the CD/DVD and the reading laser.

**Laser devices:** Laser devices are divided into the safety classes 1 to 4, as specified by DIN IEC 76 (CO) 6/VDE 0837. The optical readers installed in your vehicle are classified as safety class 1. Lasers used in devices that fall into this category are very weak and well screened, so there is no danger if used correctly.

## Media drives

### SD card readers

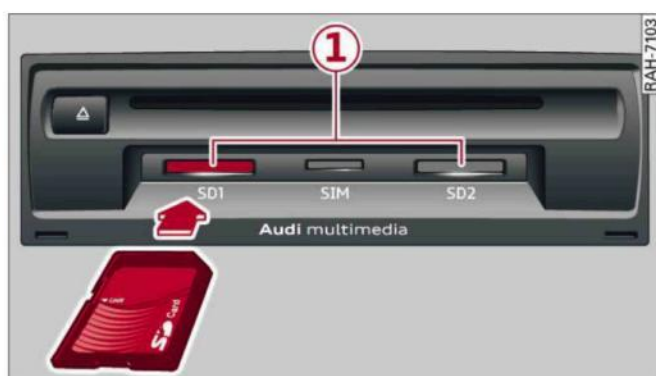

Fig. 192 Inserting an SD card

Depending on the vehicle's equipment, there may be either one or two SD card readers in the glove box 23 ⇒ page 10, Fig. 2.

- **To insert an SD card:** The missing corner of the SD card should be at the front right. Slide the SD card into the slot in the card reader 1 until you feel it engage ⇒ Fig. 192.
- **Automatic playback:** When an SD card with supported audio/video files\* ⇒ page 249 is inserted, playback will start automatically.
- **To remove an SD card:** Briefly press the SD card.

The SD card readers are called up and operated via the MMI 3 ⇒ page 243, Fig. 199.

### ! CAUTION

Only use one-piece SD cards. If you use adapter cards (more than one piece), the SD card can become detached from the adapter (e.g. caused by jolting, etc). Parts could then get stuck in the drive, impairing the functionality of the system.

### i Note

Store the SD cards in a suitable case to protect them from dirt and dust and to avoid damage.

### DVD drive

Applies to: vehicles with DVD drive



Fig. 193 DVD drive

The DVD drive is located in the glove box 23 ⇒ page 10, Fig. 2.

- **To load a CD/DVD:** The CD/DVD will be drawn in automatically. Insert the CD/DVD (text facing upwards) into the DVD slot 2 ⇒ Fig. 193, holding it straight.
- **Automatic playback:** Playback starts automatically when a CD/DVD with supported audio/video\* files ⇒ page 249 is inserted.
- **To eject a CD/DVD:** Press button 1 ⇒ Fig. 193.

After it has been ejected, the CD/DVD will be pulled back into the DVD drive automatically after about ten seconds if it is not removed from the DVD slot.

The DVD drive is called up and operated via the MMI 2 ⇒ page 243, Fig. 199.

### ! CAUTION

- Never use any force to push a CD/DVD into the drive. The CD/DVD will be drawn into the slot automatically.
- Do not insert any CDs/DVDs with stickers into the media drive. The stickers could become detached from the CD/DVD and damage the drive.

### **i** Note

Playback cannot be guaranteed if the CD/DVD contains audio/video files with a high data rate.

### CD drive

Applies to: vehicles with CD drive



Fig. 194 CD drive

The CD drive is located in the glove box **23**  
⇒ page 10, Fig. 2.

- **To load a CD:** The CD will be drawn in automatically. Insert the CD (text facing upwards) into the CD slot **2** ⇒ Fig. 194, holding it straight.
- **Automatic playback:** Playback starts automatically when a CD with supported audio files ⇒ page 250, CD drive is inserted.
- **To eject a CD:** Press button **1** ⇒ Fig. 194.

After it has been ejected, the CD will automatically be pulled back into the CD player after about ten seconds if it is not removed from the CD slot.

The CD drive is started and operated via the MMI  
⇒ page 243, Playing media.

### **!** CAUTION

- Never use any force to push a CD into the drive. The CD will be drawn into the slot automatically.
- Do not insert any CDs with stickers into the media drive. The stickers could become detached from the CD and damage the drive.

### **i** Note

Playback cannot be guaranteed if the CD contains audio files with a high data rate.

### Jukebox

Applies to: vehicles with jukebox

After you have filled the jukebox with music or videos, for example from your SD card, you can play them directly from the jukebox. The jukebox has approximately 10 GB of storage.

- ▶ Press the **MEDIA** button. Press the left control button repeatedly until the source overview ⇒ page 243 is displayed. Select and confirm **Jukebox**.

### Filling the jukebox

- Press the **MEDIA** button. Press the left control button repeatedly until the source overview ⇒ page 243 is displayed. Select one of the following sources to copy to the jukebox: SD card\*, CD-ROM\*, DVD-ROM\*, USB storage device\*.

Important: The media centre (e.g. tracks, albums) must be open.

- **To select an entry:** Select an entry from the media centre. Select: right control button > **Copy to jukebox > This entry** or **Entire list**.

Important: The playlist must be open. Refer to ⇒ page 246.

- **To choose a track:** Select the track currently being played. Select: right control button > **Copy to jukebox > This track/Entire album** or **This artist**.

Important: A video file must be playing.

- Select: right control button > **Copy to jukebox**.

The copying procedure will start and its status will be shown on the MMI.

- **To hide the copying procedure:** Select and confirm **Continue copying in background**. The copying procedure will be hidden.
- **To cancel the copying procedure:** Select and confirm **Cancel copying procedure**. Or: Remove the source from which you are currently importing files. Files that have already been copied will remain stored. ▶



Important: Copying must be in progress in the background.

- **To display the copy procedure:** Select: right control button > **Active copy procedure**.

During the copying procedure, the audio files are automatically sorted according to the categories in the media centre based on the metadata stored for the files ⇒ *page 244*. The video files copied can be found in the **Videos** category of the media centre.

### Playing from the jukebox

Important: The jukebox must contain audio/video files ⇒ *page 236, Filling the jukebox*.

The jukebox is called up and operated via the MMI ① ⇒ *page 243, Fig. 199*.

### Displaying the jukebox memory capacity

Select: right control button > **Jukebox memory capacity**. Information on the jukebox memory capacity and the number of stored tracks will be displayed.

### Deleting tracks from the jukebox<sup>1)</sup>

Important: The jukebox must contain audio/video files.

- **Delete entry:** Select an entry from the jukebox's media centre. Select: right control button > **Delete from jukebox** > **This entry** or **Entire list**.
- The status of the deletion process will be shown on the MMI. During the deletion process the playback of the jukebox is interrupted; it is started again automatically once the deletion process has been completed.

#### CAUTION

Only copy audio/video files while the engine is running; otherwise the vehicle battery will be discharged.

#### Note

- For legal reasons it is not possible to copy tracks from audio CDs onto the jukebox.

- Files that have already been copied are detected automatically and cannot be copied to the jukebox again.
- It is not possible to play audio/video files\* in the CD/DVD\* drive while they are being copied.
- For legal reasons there is no export function for the jukebox.
- Files or tracks that do not include stored metadata are listed as **Unknown**. Audi recommends that you mark the audio files with the corresponding metadata (e.g. ID3 tags).
- When handing over your vehicle e.g. to a new buyer, reset the **jukebox** to the factory settings ⇒ *page 256*.

## Bluetooth audio player

Applies to: vehicles with Bluetooth

*You can use the Bluetooth audio player to play music from your Bluetooth-enabled device (e.g. smartphone) wirelessly via the MMI.*

Important: To connect a Bluetooth device, the vehicle must be stationary and the Bluetooth function of your Bluetooth device and the **Bluetooth audio player** ⇒ *page 258* function of the MMI system must be switched on.

- To connect a **Bluetooth device:** Press the **MEDIA** button. Press the left control button repeatedly until the source overview is displayed. Select and confirm **Bluetooth audio player** ⑥ ⇒ *page 243, Fig. 200*.
- You may need to select and confirm **Not connected** > **Connect Bluetooth audio player**. The system will start searching for Bluetooth devices. Follow the instructions given by the MMI.
- Select and confirm the desired Bluetooth device from the list. The MMI will generate a PIN to establish the connection.
- Select and confirm **Yes**.
- Enter the PIN on your Bluetooth device to establish a connection. **Or:** If the PIN is already being displayed on your Bluetooth device, please confirm it on the device. You have about 30 seconds to enter the PIN.

<sup>1)</sup> Not in the **Playback** view.

Depending on the device you are using, the media are started and operated using the mobile device or the MMI.

### Note

- Pay attention to any connection queries on your Bluetooth device.
- You can bond several Bluetooth audio players to the MMI system; however only one connection can be active at a time.
- The system supports the Bluetooth protocols AVRCP (1.0/1.3/1.4) and A2DP.
- Please consider the volume control on your Bluetooth device. Audi recommends setting the volume of mobile devices to maximum when they are being used as Bluetooth audio players.
- Which media functions (e.g. random playback) are supported depends on the Bluetooth device you are using.
- For more information on which devices are supported, please go online (e.g. [www.audi.com/bluetooth](http://www.audi.com/bluetooth)) or contact an Audi dealer.

## Wi-Fi audio players

Applies to: vehicles with Wi-Fi

*The MMI's Wi-Fi audio player media source allows you to connect and operate your Wi-Fi media player (e.g. smartphone) to play music wirelessly from your player's media centre. The media player is connected via the vehicle's Wi-Fi hotspot. A UPnP server app or an integrated UPnP/DLNA server on the media player is required to access the media centre of your media player.*

Important: The Wi-Fi function of the media player must be switched on. The **Audi MMI connect** app or a UPnP server app must be installed on your media player. **Or:** You must be using a UPnP/DLNA server integrated in the media player.

- **To connect a media player:** Select the MEDIA button. Press the left control button repeatedly until the source overview ⇒ *page 243* is displayed.

played. Select and confirm **Wi-Fi audio player**  ⇒ *page 243, Fig. 200*.

- You may need to select and confirm **Wi-Fi off > Activate Wi-Fi** to switch Wi-Fi on in the MMI. Select **Wi-Fi settings** if necessary. Use the settings of the Wi-Fi hotspot for the media player you are using.
- **To start the Wi-Fi audio player:** Start the **Audi MMI connect** app or a UPnP server app, or enable media sharing on your media player.

**To use the media player:** The media player is operated using the MMI.

- Press the left control button repeatedly until the menu item **Folders** appears. Select and confirm **Folders**.
- **To play music from a media player:** Select and confirm **Media centre**.

**Internet radio:** See ⇒ *page 239*.

### WARNING

- Do not allow the features of the Wi-Fi hotspot to distract you from watching the traffic – taking your eyes off the road can cause an accident.
- Mobile devices, tablet and laptop computers and devices of a similar weight can only be operated safely when the vehicle is stationary. Like any loose object, they can be catapulted through the vehicle in an accident and cause serious injuries. Always make sure that such devices are securely stowed while you are driving.
- No Wi-Fi devices may be used from the front seats in the areas around the airbags while the vehicle is being driven. Please also observe the safety warnings on ⇒ *page 282, Front airbags*.

### CAUTION

Please always observe the information ⇒  *in Wi-Fi hotspot on page 202*.

### Note

- Inserting or removing the mini SIM card from the SIM card reader\* causes the Wi-Fi connection to be reconfigured. This may

cause a short interruption in the audio playback of some media players.

- Please always note the information in the chapter ⇒ *page 204, General notes on Audi connect (infotainment)*.
- Please note that the Wi-Fi connection does not automatically enable you to use the Internet. Further information can be found from ⇒ *page 191 onwards*.
- To avoid interruptions in audio playback, deactivate the energy saving function on your media player, or connect the player to a charger.
- The time it takes to load audio files depends on the media player in use and on the number of files stored.
- A maximum of 2,000 entries per directory are shown on the MMI.
- Tracks downloaded from music streaming services for use offline may be stored on your mobile device (e.g. smartphone) with DRM protection. Please note that files with DRM protection cannot be played by the Wi-Fi audio player.
- Audi dealerships will be able to provide you with further information on Wi-Fi audio players.

## Online media and Internet radio

Applies to: vehicles with Audi connect (infotainment)

*You can start and operate Internet radio and various online media services via the MMI.*



Fig. 195 Online media

- ▶ Press the **MEDIA** button. Press the left control button repeatedly until the source overview ⇒ *Fig. 195* is displayed.

Applies to: using online media and Internet radio

**Important:**

- The **Audi MMI connect** app must have been installed and started on your mobile device.
- You must be logged in to your myAudi account in the **Audi MMI connect** app and must have selected your vehicle.
- The Wi-Fi function must be activated on the mobile device and on the MMI.
- If necessary, open the connection manager ⇒ *page 257* and check that the mobile device you have connected is selected under **MMI connect App** (✓).
- A network connection must be set up on the MMI ⇒ *page 203*.
- The symbol for the media source **Online media** ① ⇒ *Fig. 195* must be shown on the MMI.

Applies to: using online media

**Additional requirements:**

- One of the supported online media services must be available in your country.
- You must have an account with one of the supported online media services.
- Depending on the online media service, an app may need to be installed and set up on your mobile device.

### Starting online media

- Press the **MEDIA** button. Press the left control button repeatedly until the source overview ⇒ *page 243* is displayed.
- Select and confirm an online media service.

### Starting Internet radio

- Press the **MEDIA** button. Press the left control button repeatedly until the source overview ⇒ *page 243* is displayed.
- Select and confirm **Internet radio**. The Internet radio browser or the most recently played station will be shown.
- **To select a station:** Select and confirm a category in the Internet radio **Browser** (if desired) > *a station*.

### Online media and Internet radio: Further options

- Press the right control button. ▶

The following options may be available depending on the information displayed (e.g. the station/track currently playing):

- **Sound settings:** Refer to ⇒ page 260.
- **Wi-Fi settings:** Refer to ⇒ page 201, *Wi-Fi hotspot*.
- **Connection manager:** Refer to ⇒ page 257.
- Additional options may be available depending on the active online media service or Internet radio function.

**⚠ WARNING**

- Mobile devices, tablet and laptop computers and devices of a similar weight can only be operated safely when the vehicle is stationary. Like any loose object, they can be catapulted through the vehicle in an accident and cause serious injuries. Always make sure that such devices are securely stowed while you are driving.
- No Wi-Fi devices may be used from the front seats in the areas around the airbags while the vehicle is being driven. Please also observe the safety warnings on ⇒ page 282, *Front airbags*.

**⚠ CAUTION**

- Please always observe the information ⇒ ⚠ in *Wi-Fi hotspot* on page 202.
- In order to use online media, you generally have to set up an account with an online media service, which may lead to additional costs, especially if you are using the service abroad.

**i Note**

- Depending on the Internet connection and network load, playback of the online media services may be interrupted.
- Whether **online media** and **Internet radio** can be used depends on the availability of services provided by third parties.
- AUDI AG only enables you to access online media services via the MMI system and accepts no responsibility for the content of online media services.

- Please always note the information in the chapter ⇒ page 204, *General notes on Audi connect (infotainment)*.
- Depending on the mobile device you are using, you may experience interruptions in media playback when using the **Audi MMI connect** app. To avoid interruptions, keep the **Audi MMI connect** app running in the foreground and do not lock the screen on your mobile device.
- Audi dealerships will be able to provide you with further information on online media.

## Multimedia connections

### USB adapters for Audi music interface or USB charging socket

Depending on the vehicle equipment, you may be able to connect your mobile devices (e.g. smartphones, MP3 players) to the Audi music interface or the USB charging socket using the special USB adapters.

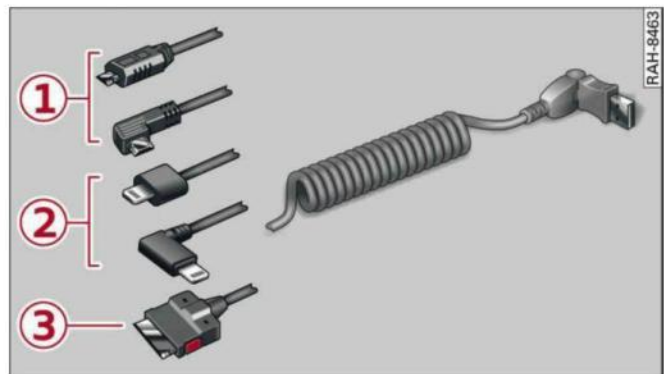

Fig. 196 Audi USB adapters

The USB adapters ⇒ Fig. 196 are available from Audi dealers or specialist retailers:

- ① USB adapter for devices with micro USB connector
- ② USB adapter for devices with Apple Lightning connector
- ③ USB adapter for devices with Apple dock connector

If the appropriate equipment is installed on your vehicle, you can connect your mobile devices to the MMI and simultaneously charge the battery using a USB adapter connected to the Audi music interface. ▶

Applies to: vehicles with Audi music interface

– **Audi music interface:** See ⇒ page 241.

Applies to: vehicles with AUX input/USB charging socket

– **AUX input/USB charging socket:** See ⇒ page 242.

### ! CAUTION

Please handle the USB adapters with care. Make sure the cable does not become pinched or trapped.

## Audi music interface

Applies to: vehicles with Audi music interface

You can connect your mobile devices via the Audi music interface in order to charge the battery and operate the devices via the MMI.



Fig. 197 Connecting mobile devices

The Audi music interface consists of a USB connection, an AUX input in the centre console under the armrest (33) ⇒ page 10, Fig. 2 and another USB connection in the centre console (37) ⇒ page 10, Fig. 2.

- **To connect a mobile device using a USB adapter:** Connect the corresponding USB adapter (2) ⇒ Fig. 197 to an Audi music interface connection (3) ⇒ Fig. 197 or (37) ⇒ page 10, Fig. 2 and then connect it to the mobile device (1) (e.g. iPod).
- **To charge a mobile device using a USB adapter:** When you connect a mobile device to an Audi music interface connection (3) ⇒ Fig. 197 or (37) ⇒ page 10, Fig. 2 using an appropriate USB adapter (2) ⇒ Fig. 197 the device's battery is charged automatically.
- **To disconnect a mobile device from the Audi music interface:** Detach the USB adapter (2) ⇒ Fig. 197 from the Audi music interface.

- **To disconnect mobile devices with Apple dock connector:** With the release tabs (3) ⇒ page 240, Fig. 196 pressed, detach the Apple dock connector from the Apple device.

Depending on the device you are using, the media are started and operated using the mobile device or the MMI ⇒ page 243.

**To connect two mobile devices:** If two mobile devices (e.g. an iPod and a smartphone) are connected at the same time, both devices can be used as a playback source.

You can connect mobile devices via the analogue **AUX** interface:

- **To connect a mobile device to the AUX input:** Connect the cable (5) ⇒ Fig. 197 to the AUX input (6) on the Audi music interface before connecting the mobile device (4) (e.g. MP3 player, smartphone).
- **To disconnect the mobile device from the AUX input:** Detach the cable (5) ⇒ Fig. 197 from the AUX input (6) ⇒ Fig. 197.
- **Operation:** Select and confirm the source **External audio player** (5) ⇒ page 243, Fig. 199. Media are started and operated using the mobile device (4) ⇒ Fig. 197.

### ! WARNING

Today's driving conditions require your full attention. As the driver, you have full responsibility for the safety of the vehicle and other road users. Never operate mobile devices while the vehicle is moving - risk of accident!

### ! CAUTION

- To avoid damaging the connection, please take care when detaching the connector from the Audi music interface.
- Use a USB extension cable to connect devices with an integrated USB connector (e.g. USB sticks). This will help to avoid damage to your USB device and the Audi music interface.
- Very high or very low temperatures (a common occurrence in a car's interior) can cause damage to mobile devices and/or impair their performance. Please do not leave your

mobile devices in the vehicle when the temperature is very high or very low.

### **i** Note

- When you switch off the ignition, the USB ports will continue to be supplied with power as long as the energy management system does not intervene.
- Do not use any additional USB extension cables or adapters when connecting mobile devices which have an integrated cable or which must be connected via a USB adapter (⇒ page 240) to the Audi music interface; this could cause performance issues.
- The AUX adapter cable is available from Audi dealers or specialist retailers.
- It cannot be guaranteed that mobile devices which do not meet the specification USB 2.0 will function properly.
- USB hubs are not supported.
- Some iPod versions (e.g. iPod shuffle) cannot be connected with the USB adapter for devices with Apple dock connector. You can connect these devices using the AUX adapter cable.
- Content that has been changed on a mobile device<sup>1)</sup> connected to the Audi music interface may not be shown in the media centre. In this case, reset the **Media settings** to the **Factory settings** ⇒ page 256.
- Video playback via the Audi music interface is only supported if the system detects that the device connected is a USB storage device (e.g. a USB stick). Apple or MTP devices (e.g. smartphones) are not recognised as USB storage devices.
- iPod/iPhone malfunctions also affect operation of the device via the MMI. In this case, please reset your iPod/iPhone.
- Please refer to the iPod/iPhone operating instructions for important information on how to use your iPod/iPhone. We recommend that you use the most up-to-date iPod/iPhone software possible.

- For more information on the Audi music interface and on which devices are supported, please see the Audi mobile device database at [www.audi.com/bluetooth](http://www.audi.com/bluetooth) or contact an Audi dealer.

### AUX input/USB charging socket

Applies to: vehicles with AUX input/USB charging socket

You can charge the batteries of your mobile devices using the USB charging socket. You can connect mobile devices using the analogue AUX interface.



Fig. 198 USB charging socket and AUX input

The USB charging socket and the AUX input are located under the armrest in the centre console 33 ⇒ page 10, Fig. 2.

#### AUX input

- **To connect a mobile device to the AUX input:** Connect the cable 5 ⇒ Fig. 198 to the AUX input 6 before connecting the mobile device 4 (e.g. MP3 player, smartphone).
- **To disconnect the mobile device from the AUX input:** Detach the cable 5 ⇒ Fig. 198 from the AUX input 6 ⇒ Fig. 198.
- **Operation:** Select and confirm the source **External audio player** 5 ⇒ page 243, Fig. 199. Media are started and operated using the mobile device 4 ⇒ Fig. 198.

#### USB charging socket\*

- **USB adapter:** See ⇒ page 240, *USB adapters for Audi music interface or USB charging socket.*

<sup>1)</sup> Applies to MTP devices only. Does not apply to Apple or USB mass storage devices.

- **To charge a mobile device using a USB adapter:** Connect your mobile device ① ⇒ Fig. 198 to the charging socket ③ using the appropriate USB adapter ②.
- **To disconnect the USB adapter from the charging socket:** Detach the USB adapter ② ⇒ Fig. 198 from the USB charging socket.
- **To disconnect mobile devices with Apple dock connector:** With the release tabs ③ ⇒ page 240, Fig. 196 pressed, detach the Apple dock connector from the Apple device.

### ⚠ WARNING

Today's driving conditions require your full attention. As the driver, you have full responsibility for the safety of the vehicle and other road users. Never use mobile devices while the vehicle is moving - risk of accident!

### ! CAUTION

- To avoid damaging the connection on the Audi music interface, please take care when unplugging the connector from the AUX input or the USB charging socket.
- Very high or very low temperatures (a common occurrence in a car's interior) can cause damage to mobile devices and/or impair their performance. Please do not leave your mobile devices in the vehicle when the temperature is very high or very low.

### i Note

- When you switch off the ignition, the USB ports will continue to be supplied with power as long as the energy management system does not intervene.
- USB charging sockets marked **CHARGE ONLY** cannot transfer data and are intended for charging only.
- Do not use any additional USB extension cables or adapters when connecting mobile devices which must be connected to the USB charging socket ③ ⇒ Fig. 198 via a USB adapter (⇒ page 240); this could cause performance issues.
- The AUX adapter cable is available from Audi dealers or specialist retailers.

- USB hubs are not supported.
- Please refer to the operating instructions of your mobile device for important information on its operation.
- It cannot be guaranteed that all mobile devices will function without any problems.
- Using a mobile device with the engine switched off will drain the vehicle's battery.
- Audi recommends setting the volume of a mobile device connected to the AUX input to about 70 % of maximum.

## Playing media

### Calling up media

You can start and operate various types of media via the MMI control console.



Fig. 199 Illustration: Possible sources in the media menu



Fig. 200 Illustration: Possible sources in the media menu

**Important:** A media source must contain audio/video\* files ⇒ page 235.

- ▶ Press the **MEDIA** button. Press the left control button repeatedly until the source overview is displayed.
- ▶ Select and confirm the desired source. **Or:** Press the **MEDIA** button repeatedly until the desired source is selected.

You can select the following sources in the **Media** menu, depending on the vehicle equipment: ▶

- ① Jukebox\* ..... 236
- ② DVD/CD drive\* ..... 235, 236
- ③ SD card reader ..... 235
- ④ Audi music interface\* ..... 241  
e.g. iPod, USB stick
- ⑤ External audio player ..... 242  
e.g. an MP3 player connected to  
the AUX input
- ⑥ Bluetooth audio player\* ..... 237
- ⑦ Wi-Fi audio player\* ..... 238
- ⑧ Online media\* and Internet radio\* .. 239

- **To play audio/video files:** Select a source in the **Media** menu > *category* (e.g. artist > album > track/title).
- **To access the next level up in the structure of folders:** Press the **BACK** button. **Or:** Select and confirm **Go up**.
- **To select the previous/next item<sup>1)</sup>:** Briefly press the ON/OFF button on the MMI control console to the left/right (◀/▶).
- **To rewind/fast forward audio/video\* files:** Move and hold the ON/OFF button to the left/right (◀◀/▶▶).
- **To pause/resume playback:** Briefly press the ON/OFF button on the MMI control console.

### **i** Note

- You can scroll rapidly through long lists by turning the rotary pushbutton quickly. The scrolling speed depends on the number of entries in the list.
- If the **Traffic announcements** ⇒ page 229 or **DAB announcements\*** function is switched on, playback is interrupted for announcements. You can cancel an announcement while it is being played by briefly pressing the ON/OFF button on the MMI control console.
- For safety reasons, the video picture is not available while the vehicle is moving. While you are driving, only the sound is played.

## Media centre

Several categories for selecting audio/video\* files are available in the media centre.



Fig. 201 Example: Categories for a USB stick



Fig. 202 Example: Categories for a USB stick

- ▶ Press the **MEDIA** button. Press the left control button repeatedly until the source overview is displayed. Select and confirm the desired source.

### ① Active source

The active source is highlighted. The symbol for the active source ① may change depending on the device connected or the online media\* or Internet radio\* service in use. The device name may be displayed (e.g. MyPhone). A USB stick connected via the Audi music interface\* is shown as an example ⇒ Fig. 201.

Depending on the active source, you can select audio/video\* files from the following categories and copy them into the playlist:

### ② Favourites

The category **Favourites** appears if at least one item has been stored as a favourite. Refer to ⇒ page 246, *Favourites*.

<sup>1)</sup> May not be possible during playback (depends on the DVD).



### ③ Artists

All available artists are displayed. Select and confirm an artist, an album and then a track.

### ④ Albums

All available albums are displayed. Select and confirm an album and then a track.

### ⑤ Genres

All available genres are displayed. Select and confirm a genre (e.g. **Pop**), an artist, an album and then a track.

### ⑥ Tracks

All available tracks are displayed. Select and confirm a track.

### ⑦ Folders

The folder structure or the track/title/chapter list is displayed. Select a folder (if applicable) and select and confirm an item in it.

### ⑧ Playlists

All playlists on the source along with the intelligent playlists are displayed. Select and confirm a playlist and then a track.

#### Intelligent playlists:

- **Last tracks played:** The most recently played tracks from the selected source are displayed.
- **Most played:** The tracks you have played most often from the selected source are displayed.
- **5 stars to 1 star:** Tracks from the selected source are displayed according to their rating.
- **Unrated:** All files without rating information (e.g. ID3 tag) in the selected source are displayed.

### ⑨ Videos\*

All available video files are displayed. Select and confirm a video file.

#### **i** Note

- Only the categories supported by the medium used are available. For example, CD/DVD-ROM tracks cannot be selected via categories such as **Artists**, **Albums** or **Genres**. The categories **Podcasts**, **Audiobooks** and

**Composers** are available when you are using an iPod (source: Audi music interface ⇒ *page 240*).

- For safety reasons, the video picture is not available while the vehicle is moving. While you are driving, only the sound is played.
- If you synchronise a portable player with "cloud" services, the playlists may not be displayed correctly on the MMI. Use the device's local media library.

### Search function

Applies to: vehicles with search function

You can search for e.g. tracks and video files\* in the active source.



Fig. 203 Entry field and results list for the search function

Depending on the selected source, you can call up the **search** function.

Important: The playlist ⇒ *page 246* or the media centre ⇒ *page 244* must be displayed.

#### Calling up the search function

- ▶ Turn the rotary pushbutton to the left until the entry field ① ⇒ *Fig. 203* for the **search function** is displayed. **Or:** Push the rotary pushbutton upwards.

**To use the search function:** Refer to ⇒ *page 160*, *Search function*.

Entries containing the search terms entered will be displayed in the list of results ⑤ ⇒ *Fig. 203*. You can search by artist ② ⇒ *Fig. 203*, album ③ or track ④. You can also search for genres and videos.

#### **i** Note

- The system will only search for files on the active source.

- If the search function is called up in the **Folders** category (7) ⇒ *page 244, Fig. 202*, the system will only search for files in the current folder. This is also the case in the **Composers**, **Podcasts** und **Audiobooks** categories.

## Playlist



Fig. 204 Example: Playlist

The track, artist, album and, if available, the album cover are displayed in the playlist ⇒ *Fig. 204*.

## Options menu

Refer to ⇒ *page 246, Other settings*.

## Favourites

*You can store up to 50 items per media source in the list of favourites, in any order.*

Important: The playlist or the media centre must be open.

- Select the desired item from the playlist or the media centre.
- Select: right control button > **Store as favourite**. Or: Press and hold the rotary pushbutton for several seconds.

When a track is stored as a favourite, the corresponding album is shown as a favourite in the favourites list.

Important: At least one item must be stored in the favourites list.

**To display the favourites list:** Select the MEDIA button. Press the left control button repeatedly until the source overview ⇒ *page 243* is displayed. Select a source which supports *Catego-*

*ries* ⇒ *page 244* (e.g. an SD card). Select the **Favourites** category.

Important: The favourites list must be displayed.

- **To listen to a favourite:** Select and confirm *a favourite from the list*.
- **To move a favourite:** Select *a favourite from the list* > right control button > **Move favourite**. Select and confirm the position of the favourite selected.
- **To delete a favourite:** Select *a favourite from the list* > right control button > **Delete favourite** > **Delete this favourite** or **Delete all favourites**.

## Other settings

### Options menu

Different context-specific functions and settings are available depending on which source is selected.

- ▶ Press the right control button.

### Sound settings

Refer to ⇒ *page 260*.

### Input level

Important: A mobile device must be connected via an AUX adapter cable or a USB adapter ⇒ *page 240, Multimedia connections*.

The volume of the mobile device will be adapted to the MMI system. We recommend setting the volume of the mobile device to about 70 percent of the maximum volume.

### Bluetooth settings

Refer to ⇒ *page 258*.

### Wi-Fi settings\*

Refer to ⇒ *page 201, Wi-Fi hotspot*.

### Connection manager

Refer to ⇒ *page 257*.

### Detailed track info

When this function is switched on  and the playlist is open, information on the selected track (e.g. the artist, album, album cover\*) as well as ▶

the total and remaining playing time will be displayed.

### Jukebox memory capacity\*

Information on the jukebox memory capacity and the number tracks stored on the jukebox will be displayed.

### Change play position

Turn the rotary pushbutton to the left or right.

**Or:** Move your finger from left to right across the MMI touch pad\*.

### Random playback<sup>1)</sup>

When this function is switched on , all the files in the playlist will be played and shown in random order.

### Repeat track<sup>1)</sup>

When the function is switched on , the current track will be repeated.

### Back to 'Playback'

The options menu will be closed. The track currently playing will be shown in the playlist.

### Play similar music\*

The track currently playing is briefly analysed (e.g. by artist, genre, mood, time) so that the system can display an intelligent playlist with similar tracks.

### Play more...

An intelligent playlist is displayed based on the track currently playing. You can choose between a playlist with more tracks **by this artist, of this album** or **of this genre**.

### Copy to jukebox\*

Refer to ⇒ *page 236, Filling the jukebox*.

### Set as ring tone\*<sup>2)</sup>

Important: A mobile phone must be connected to the MMI and the track currently playing must be on the jukebox\* ⇒ *page 236*.

The selected track will be used as the ring tone for incoming calls.

### Gracenote online database\*

Important: The MMI must be connected to the Internet.

When this function is switched on , various information will be downloaded for the track currently playing, if any is available.

### Favourites

Refer to ⇒ *page 246*.

### Further options

Important: The vehicle must be stationary and a video file\* or a DVD\* must be playing.

### Child lock\*

You can use the child lock to restrict video DVD playback.

Enter the child lock password. The password set at the factory is **1234**. The following options are available:

- **Safety level:** Select and confirm a safety level (e.g. level 5). Eight safety levels are available for the child lock function. If you select child lock level 5, all DVDs with safety levels 1-5 can be played. Playback of DVDs with a higher safety level will be blocked. Select **No restriction** to remove all restrictions.
- **Change password:** You can change the current password.

### Switch to full screen

The video picture is displayed. Press the rotary pushbutton to show the playlist. **Or:** Press the **BACK** button.

### Replay video<sup>1)</sup>

When the function is switched on , the current video will be replayed. ▶

<sup>1)</sup> This function is automatically deactivated if you change the source.

<sup>2)</sup> This function is not available for all mobile phones.

## Display DVD menu

The DVD main menu will be called up on the infotainment display.

- **To select a menu option:** Select and confirm a menu option. **Or:** Move your finger on the MMI touch pad\* and press the rotary pushbutton.

## Audio track<sup>1)</sup>

You can adjust the audio track (language and audio format) manually. It depends on the video DVD whether different languages and audio formats are available.

## Subtitles<sup>1)</sup>

You can select subtitles manually. It depends on the video DVD whether different languages are available.

## Picture format

We recommend using the **automatic** setting for the picture format. Depending on the active file or source (e.g. video file\*, DVD\*), you may be able to adjust the picture format.

| Picture format   | Description  |
|------------------|--|
| <b>automatic</b> | The MMI detects the picture format of the source and displays the picture using the best possible width-to-height ratio. Depending on the source format and the infotainment display installed, black bars may be displayed on the edges of the picture. |
| <b>zoom</b>      | The picture is enlarged to fill the infotainment display. Switch this function off if the picture is distorted.  |

| Picture format      | Description  |
|---------------------|--|
| <b>cinema-scope</b> | Use this setting for films in the cinema format 21:9. Black bars will be shown on the upper and lower edges of the infotainment display.   |
| <b>original</b>     | The picture will be displayed using the picture ratio of the source format. Select this option if the picture shown with <b>auto</b> selected is distorted or partially cut off. |
| <b>4:3</b>          | The picture is set to a width-to-height ratio of 4:3. Black bars will be shown on the edges of the infotainment display.   |
| <b>16:9</b>         | The picture is set to a width-to-height ratio of 16:9. Black bars will be shown on the upper and lower edges of the infotainment display.  |



### Note

- Not all video DVDs have a child lock feature.
- The **child lock** safety levels comply with the US standards of the Motion Picture Association of America (MPAA). Please note that age ratings for DVDs may vary between different European countries.
- If you enter the wrong **child lock** password three times in a row, you will not be able to enter a password for approximately one minute. The password can only be reset by an Audi workshop.

<sup>1)</sup> May not be possible during playback (depends on the DVD).

## Supported media and file formats

### Overview

The following audio/video file specifications are supported by the DVD drive\*, the jukebox\*, the SD card reader(s) and the connection for the USB mass storage device\*:

|                        | Audio files  |                              |                        |                           | Video files*                                    |                                 |                       |
|------------------------|--|------------------------------|------------------------|---------------------------|---|---------------------------------|-----------------------|
| <b>Supported media</b> | <p><b>SD/SDHC/SDXC/MMC memory cards:</b> with a capacity of up to 128 GB</p> <p><b>DVD drive:</b> audio CDs (up to 80 minutes) with CD text (artist, album, tracks)*; CD-ROMs with a capacity of up to 700 MB; DVD±R/RW; video DVDs; audio DVDs compatible with video DVD;</p> <p><b>Audi music interface:</b> mobile devices ⇒ <i>page 240</i> (e.g. iPod, MTP players, USB mass storage devices belonging to “USB Device Subclass 1 and 6” compatible with USB 2.0, USB sticks, USB MP3 players (plug-and-play capable), external USB flash memories and external USB hard drives)</p> |                              |                        |                           |   |                                 |                       |
| <b>File system</b>     | <p><b>Memory cards:</b> exFAT, FAT, FAT32, NTFS</p> <p><b>USB mass storage devices:</b> FAT, FAT32, NTFS</p> <p><b>USB mass storage partitions (primary/logical*):</b> 2 per USB connection</p> <p><b>CD/DVD file systems:</b> ISO9660, Joliet, UDF</p>  |                              |                        |                           |   |                                 |                       |
| <b>Metadata</b>        | <p><b>Album covers:</b> GIF, JPG, PNG up to 800x800 px.; depending on availability, the album cover will be displayed using the corresponding medium or Gracenote*.</p>  |                              |                        |                           |   |                                 |                       |
| <b>Format</b>          | MPEG-1/-2 Layer 3  | Windows Media Audio 9 and 10 | MPEG-2/-4              | FLAC                      | MPEG-1/-2                                       | MPEG4 AVC (H.264)               | Windows Media Video 9 |
| <b>File extension</b>  | .mp3   | .wma                         | .m4a;<br>.m4b;<br>.aac | .flac                     | .mpg;<br>.mpeg                                  | .mp4;<br>.m4v;<br>.mov;<br>.avi | .wmv;<br>.asf         |
| <b>Playlists</b>       | .M3U; .PLS; .WPL; .M3U8; .ASX  |                              |                        |                           |   |                                 |                       |
| <b>Specifications</b>  | Up to max. 320 kbit/sec and 48 kHz sampling frequency  |                              |                        | 48 kHz sampling frequency | Up to max. 2000 kbit/sec, 720x576 px and 25 fps |                                 |                       |
| <b>Number of files</b> | <p><b>DVD drive*:</b> max. 1000 files per medium</p> <p><b>Jukebox*:</b> memory approx. 10 GB; max. 3000 files can be copied</p> <p><b>USB mass storage devices and memory cards:</b> max. 10000 files per medium; max. 1000 files per playlist/directory</p>  |                              |                        |                           |   |                                 |                       |

### Note

- The format Windows Media Audio 9 Voice is not supported by the media drives.
- Audi recommends a compression rate of at least 160 kbit/sec for MP3 files. In the case

of audio files with variable bit rate, the display of the remaining playing time may differ from the actual figure.

- The display of country-specific characters (e.g. for ID3 tag information) depends on the language set on the system; it cannot

be ensured that these characters are always displayed correctly.

- The manufacturer will provide you with information on the “USB Device Subclass” of a USB memory device.

- Some functions of MTP players such as video playback and the rating of tracks are not supported.

**CD drive**

Applies to: vehicles with CD drive

The CD drive supports the following audio file specifications:

| Audio files            |  |
|------------------------|--|
| <b>Supported media</b> | Audio CDs (up to 80 minutes) with CD text (artist, album, track)*, CD-ROMs with a capacity of up to 700 MB   |
| <b>File system</b>     | <b>CD file systems:</b> ISO9660, Joliet, UDF   |
| <b>Metadata</b>        | <b>Album covers:</b> GIF, JPG, PNG up to 800x800 px.; depending on availability, the album cover will be displayed using the corresponding medium. |
| <b>Format</b>          | MPEG-1/-2 Layer 3      Windows Media Audio 9 and 10      MPEG-2/-4      FLAC   |
| <b>File extension</b>  | .mp3      .wma      .m4a; .m4b; .aac      .flac  |
| <b>Playlists</b>       | .M3U; .PLS; .WPL; .M3U8; .ASX  |
| <b>Specifications</b>  | Up to max. 320 kbit/sec and 48 kHz sampling frequency      48 kHz sampling frequency   |
| <b>Number of files</b> | max. 1000 files per medium   |

**Note**

- We recommend a compression rate of at least 160 kbit/sec for MP3 files. In the case of audio files with variable bit rate, the display of the remaining playing time may differ from the actual figure.

- The display of country-specific characters (e.g. for ID3 tag information) depends on the language set on the system; it cannot be ensured that these characters are always displayed correctly.

**Troubleshooting**

| Subject   | Advice   |
|---|--|
| <b>Audi music interface*/Bluetooth audio player*:</b> The mobile device is not supported.           | Please observe the notes in the chapter ⇒ <i>page 240, Multimedia connections</i> /⇒ <i>page 237, Bluetooth audio player</i> . For information on which mobile devices are supported, please see the Audi mobile device database at <a href="http://www.audi.com/bluetooth">www.audi.com/bluetooth</a> . |
| <b>Audi music interface*:</b> When starting playback via the AUX input, the volume is too high/low. | Set the volume of the mobile device to about 70% of maximum ⇒ <i>page 246, Input level</i> .   |

| Subject   | Advice  |
|---|---|
| <b>Audi music interface*</b> : The portable player is not recognised as a source.   | On some mobile phones or mobile devices, playback is not possible if the battery charge is very low (less than 5% of its capacity). After it has been plugged in, the mobile device will only be recognised as a source in the MMI again when it has sufficient battery charge.   |
| <b>Audi music interface*</b> : Problems during audio playback via an iPod/iPhone.   | The <b>Bluetooth audio player</b> function is switched on. Switch the function off ⇒ <i>page 258</i> when you are not using a <b>Bluetooth audio player</b> .   |
| <b>Audi music interface*</b> : Content that has been changed on a mobile device connected to the Audi music interface* is not shown in the media centre.              | Reset the <b>Media settings</b> to the factory settings ⇒ <i>page 256</i> .   |
| <b>AUX input</b> : Interference audible when plugging in or unplugging the AUX adapter cable.   | <b>External audio player</b> is selected as the source when the adapter cable is being connected. Activate the mute function (see ⇒ <i>page 261</i> ) or another audio source (e.g. ⇒ <i>page 228, Calling up the radio menu</i> ) before connecting/disconnecting your mobile device.  |
| <b>Bluetooth audio player*/Wi-Fi audio player*</b> : Playback problems.   | To ensure problem-free playback, only <i>one</i> interface should be in use at any one time.  |
| <b>Wi-Fi audio player*</b> : Playback problems.   | Some mobile phones may experience audio playback problems if the Internet connection in the vehicle was not established via the SIM card reader* or embedded SIM card of the MMI control console while the <b>mobile data</b> option is activated on the mobile phone. Deactivate the <b>mobile data</b> option on your mobile phone. |
| <b>Jukebox*</b> : The tracks in the imported playlists are greyed out.  | When importing playlists, you must copy all files yourself.   |
| <b>Jukebox*</b> : Imported tracks cannot be played or cannot be found.  | If you cannot find imported tracks via the media centre, this could mean that they are not supported. Please only copy supported files ⇒ <i>page 249</i> to the jukebox.  |
| <b>Wi-Fi audio player*</b> : More than one device is connected to the Wi-Fi hotspot. A media player (e.g. a smartphone) is shown as the source and cannot be changed. | Close the <b>Audi MMI connect</b> app on the connected devices (e.g. smartphones) that you do not want to use as the Wi-Fi audio player*. Also close any UPnP server apps on the devices, or disable media sharing on any integrated UPnP/DLNA servers. Connect the desired device as a Wi-Fi audio player* ⇒ <i>page 238</i> .       |
| <b>Online media*</b> : Failure of connection between the MMI and the <b>Audi MMI connect</b> app.   | The MMI connection switch on the status screen of the <b>Audi MMI connect</b> app must be switched on to establish a connection with the MMI.   |
| <b>Wi-Fi audio player*/Online media and Internet radio*</b> : Playback problems.  | Audio playback problems can occur if the <b>Connection to personal hotspot</b> function ⇒ <i>page 202</i> is activated and your personal hotspot ⇒ <i>page 195</i> is not in range. To avoid playback problems, switch the function off when you are not using a personal hotspot. ►  |

| Subject   | Advice   |
|---|--|
| <b>Audi music interface*</b> : Content that has been changed on a mobile device <sup>a)</sup> connected to the Audi music interface is not shown in the media centre. | Reset the <b>Media settings</b> to the factory settings ⇨ <i>page 256</i> .  |
| <b>Bluetooth audio player*</b> : Problems with track display and playback.  | Problems can occur if a third party music playback app is open when you are playing audio via the <b>Bluetooth audio player</b> . Audi recommends that you use the integrated media player on your Bluetooth device (e.g. smartphone). |
| <b>Wi-Fi hotspot*</b> : Wi-Fi hotspot connection to your Wi-Fi device interrupted.  | Make sure that the network optimisation function is switched off in the Wi-Fi settings or network settings of your Wi-Fi device. Please refer to the operating manual of your Wi-Fi device for further details.                        |
| <b>Audi music interface</b> : No audio playback possible via a connected mobile device.   | Make sure that the USB mode <i>MTP</i> is selected in your mobile device's settings.   |

<sup>a)</sup> Applies to MTP devices only. Does not apply to Apple or USB mass storage devices.



## Audi smartphone interface

### Setting up<sup>1)</sup>

Applies to: vehicles with Audi smartphone interface

You can connect your smartphone to the MMI system via the Audi smartphone interface. Some of the content on your smartphone is displayed in an optimised screen format on the infotainment display and can be operated via the MMI control console.

#### Important

The vehicle must be stationary, and the ignition must be switched on.

iPhone 5 or later with Lightning connector and operating system iOS 7.1.2 or higher **or**:

Smartphone with Android Auto app and operating system Android 5.0 Lollipop or later.

- ▶ Connect your smartphone to the Audi music interface ⇒ *page 241* via a USB adapter ⇒ *page 240, Fig. 196*.
- ▶ Select and confirm **Activate Apple CarPlay** or **Activate Android Auto now**.
- ▶ Follow the instructions given by the system.
- ▶ Please note any system queries on your smartphone.

If you decline the use of Apple CarPlay or Android Auto the first time you connect your smartphone, you can start the Audi smartphone interface at a later time via the **connection manager**.

- ▶ Select: **[MENU]** button > **Audi smartphone interface** > **Switch to connection manager**.
- ▶ Connect your smartphone to the Audi music interface via a USB adapter ⇒ *page 240, Fig. 196*.
- ▶ Select and confirm **Audi smartphone** in **Connection manager** ⇒ *page 257*. You can select your smartphone from the list of devices already connected ⇒ *page 258*.
- ▶ Follow the instructions given by the system.

#### ! CAUTION

Please always observe the information ⇒ ! in *Wi-Fi hotspot* on *page 202*.

#### i Note

- The functions you can use depend on a number of factors including:
  - The brand of your smartphone
  - The operating system version of your smartphone
  - The software version of the app in use
  - The USB adapter/cable and the correct connection
  - Your mobile network/service provider
  - The individual settings on your smartphone
- One or several of the factors listed above can result in your smartphone being incompatible with the Audi smartphone interface. We regret that it is not possible to guarantee compatibility for all types of smartphone. For further information and support, please refer to the operating manual of your smartphone or contact its manufacturer.
- If the smartphone you have connected has a voice control feature, you can control your smartphone using the external speech control system ⇒ *page 170*.
- The menu language displayed on the MMI is based on the setting on your smartphone.
- The time displayed on the MMI is based on the setting on your smartphone.
- Some of the MMI functions are not available while an Apple CarPlay or Android Auto connection is active.
- You cannot use mobile devices via Bluetooth when an Apple CarPlay connection is active.
- If you have inserted your own mini SIM card in the SIM card reader\* for making phone calls, the SIM card will be used exclusively for a data connection when the Audi smartphone interface and the car phone function\* ⇒ *page 172* are active.

<sup>1)</sup> Not available in all markets.

– **Tag this song for iTunes\***<sup>1)2)</sup> is not available while an Apple CarPlay connection is active  
⇒ *page 229*.

**Android Auto:** To open the menu bar of Android Auto, push the rotary pushbutton downwards.

### Calling up a menu item

Use the MMI control console to select an item from the menu and confirm it.

## How to use

Applies to: vehicles with Audi smartphone interface

### Calling up the menu

**Apple CarPlay:** To return to the main menu of Apple CarPlay from any other menu, press and hold the **BACK** button.

## Troubleshooting

Applies to: vehicles with Audi smartphone interface

| Subject   | Advice  |
|---|---|
| <b>Audi smartphone interface</b> cannot be called up. | Check the battery charge level on your smartphone.<br>Check the USB cable and try using another one.<br>Check whether Android Auto or Apple CarPlay is available in your country.<br><b>Android Auto:</b> Check that the Android Auto app is installed on your smartphone.  |
| <b>Connecting</b> the smartphone to the MMI fails.    | Check that you are using the correct USB adapter and that the USB adapter is correctly connected to your smartphone and to the Audi music interface<br>⇒ <i>page 240</i> .<br><b>Apple CarPlay:</b> Check that Apple CarPlay is activated on your smartphone.<br><b>Android Auto:</b> Check in the Android Auto app whether Android Auto allows new cars. |
| Smartphone is not detected automatically.             | Check that you are using the correct USB adapter and that the USB adapter is correctly connected to your smartphone and to the Audi music interface<br>⇒ <i>page 240</i> .<br>Check that the requirements for connecting a smartphone have been met.  |

1) Still under development at the time of print.

2) This function is only available in the Mexican market.

## System settings

### Setting the time and date

The time can be set manually or via GPS\*.

- ▶ Select: **MENU** button > **Settings** > left control button > **MMI settings** > **Date & time**.
- ▶ Or: Select: **MENU** button > **Car** > left control button > **Vehicle settings** > **Date & time**.

#### Set automatically

The time and date are automatically updated when this function is switched on .

#### Time

Important: The **Set automatically** function must be deactivated.

Press the rotary pushbutton. You can adjust the **time** manually by turning and pressing the rotary pushbutton.

#### Date

Important: The **Set automatically** function must be deactivated.

Press the rotary pushbutton. You can adjust the **date** manually by turning and pressing the rotary pushbutton.

#### Time zone

When selecting the correct time zone, a list of corresponding countries is displayed as an example.

#### Automatic time zone\*

When this function is activated , the time is automatically adjusted to the relevant time zone.

#### Automatic summer time\*

When this function is activated , the time is automatically adjusted from normal time to summer time.

#### Time format

When this option is set to **24h**, for example **13:00** will be displayed as the time. When it is set to **AM/PM**, for example **1:00 PM** will be displayed.

#### Date format

When this option is set to **DD.MM.YYYY**, for example **31.08.2017** will be displayed as the date. When it is set to **MM/DD/YYYY**, for example **08/31/2017** will be displayed. When it is set to **YYYY-MM-DD**, for example **2017-08-31** will be displayed.

### MMI settings

- ▶ Select: **MENU** button > **Settings** > left control button > **MMI settings**.

#### Language

You can change the language of the display along with the language of the navigation cues\* and the speech dialogue system\*.

The number of languages available depends on the market.

#### Measurement units

The following measurement units are available:

- **Speed** (km/h or mph)
- **Distance** (km or miles)
- **Temperature** (°C or °F)
- **Consumption** (ltr/100 km, mpg (US), mpg (UK) or km/ltr)
- **Capacity** (litres, gallons)

#### Reminder signal

Applies to: vehicles with Audi phone box

Important: Your mobile phone must be Qi compatible<sup>1)</sup>, or it must be connected to the Audi music interface **1** ⇒ page 177, Fig. 161 using a USB adapter cable.

You can use the reminder signal to keep yourself informed of the charging status of the mobile ▶

1) The Qi standard enables you to charge your mobile phone wirelessly.

phone in the Audi phone box\*. The following settings are available:

- **off:** Switches the reminder signal off.
- **sound:** A sound is played as the reminder signal.
- **spoken:** The reminder signal is spoken by the system.

**Reminder signal volume:** You can adjust the volume of the reminder signal by turning the rotary pushbutton.

**Switch off pop-up:** This function is switched off at the factory. When this function is switched on , the messages about the charging status of the mobile phone in the Audi phone box\* on the infotainment display will not appear. The reminder not to forget the mobile phone when leaving the vehicle will also be switched off.

### Usage tips

Your MMI displays usage tips when this function is switched on . They will appear less often as time goes by.

### Speech dialogue system

Applies to: vehicles with speech dialogue system

The following functions are available depending on the equipment installed in your vehicle:

**Command display:** The MMI displays possible voice commands in the corresponding menu when this function is switched on .

**Short dialogue:** When this function is switched on , the spoken cues are shortened.

**Command during speech dialogue\*:** This option is activated when the vehicle leaves the factory. When this option is activated , you can say a new command while the system is giving a spoken cue, rather than waiting for the beep. When this option is deactivated , wait until you hear the beep to say a command.

**Volume:** You can adjust the volume of the spoken cues by turning the rotary pushbutton.

**Individual speech training** (only possible when the vehicle is stationary): You can use the individual speech training to adapt the speech dialogue system to your voice or pronunciation so that the

speech dialogue system can then better recognise what you are saying. The individual speech training prompts you to repeat 20 spoken phrases that consist of certain commands and blocks of digits. If you would like to delete the stored speech training setup, you can use the function **Reset individual speech training**.

### Display brightness

**Display brightness:** You can adjust the brightness of the infotainment display by turning the rotary pushbutton.

### Factory settings

You can reset the following functions to the factory settings:

- **Sound settings**
- **Radio**
- **Media settings**
- **Jukebox\***
- **Directory**
- **Telephone**
- **Bluetooth and Wi-Fi\***
- **Navigation settings\***
- **Navigation and online memory\***
- **Speech dialogue system\***
- **Message settings\***
- **Apps\***
- **Usage tips**
- **Audi connect\***
- **Audi smartphone interface\***

You can select the desired options individually or mark **Select all entries**. Select and confirm **Restore factory settings**.

#### Note

Please note that not only settings will be deleted when you do this; saved data may also be erased.

## Connection manager

### Introduction

The connection manager gives you an overview of your connected devices and their connection status.

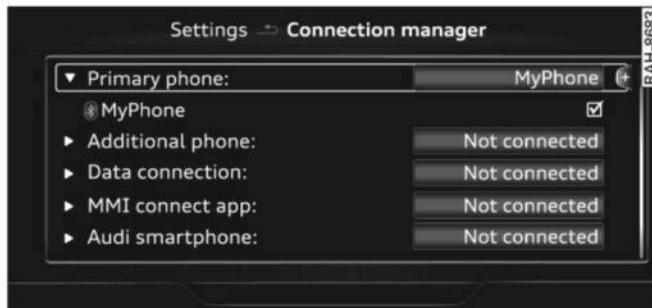

Fig. 205 Connection manager

- ▶ Select: **[MENU]** button > **Settings** > left control button > **MMI settings** > **Connection manager**.
- ▶ Select and confirm a menu option.

If a mobile device has already been connected and you then select and confirm the corresponding menu item, the device's name and connection mode is displayed under this menu item ⇒ Fig. 205.

You can **connect** (☑) or **disconnect** (☐) a connected device individually.

### Telephone

Applies to: vehicles with telephone

- **Connect new device:** You can search for and connect a mobile phone.
- **List of devices already bonded:** Select your mobile phone from the list of all devices which have already been bonded. **Or:** Insert your own mini SIM card in the SIM card reader\* ⇒ page 176.

### Second phone

Applies to: vehicles with Audi phone box

- **Connect new device:** You can search for and connect a mobile phone.

- **List of devices already bonded:** Select your mobile phone from the list of all devices which have already been bonded.

### Data connection

Applies to: vehicles with Audi connect (infotainment)

Applies to: option using the embedded SIM card

- The embedded SIM card<sup>1)</sup> will be used for the data connection ⇒ page 191. You do not need to adjust any other settings.

Applies to: option using your own SIM card

- **Connect new device:** You can search for and connect a mobile device (e.g. a smartphone).
- **List of devices already bonded:** Select your mobile phone from the list of all devices which have already been bonded. **Or:** Insert your own mini SIM card in the SIM card reader\*.

### ! CAUTION

Please always observe the information ⇒ ! in *Wi-Fi hotspot on page 202*.

### MMI connect app

Applies to: vehicles with Audi connect (infotainment)

Important: The **Audi MMI connect** app must be installed on your mobile device and have been started.

- **Connect new device:** You can search for and connect a mobile device (e.g. a smartphone).
- **List of devices already bonded:** Select your mobile device from the list of all devices which have already been bonded.

### Music

Applies to: vehicles with Bluetooth audio player or Wi-Fi audio player

### Audio player\*

Important: The Bluetooth function and the discoverability option of both the MMI system ⇒ page 258 and the mobile phone must be activated. ▶

1) SIM card installed in vehicle at factory.

- **To connect a new device:** Press the rotary push-button. Select **Bluetooth audio player**. Search for and connect a mobile device.
- **List of devices already bonded:** Select a Bluetooth device from the list of all devices which have already been bonded.

### Wi-Fi audio player\*

Important: The Wi-Fi hotspot\* on the MMI system ⇒ *page 201* and your mobile phone must be activated.

- **To connect a new device:** Press the rotary push-button. Search for and connect a Wi-Fi enabled device.
- **To disconnect a Wi-Fi audio player:** Deactivate Wi-Fi on your Wi-Fi enabled device. The device will be removed from the list automatically.

### CAUTION

Please always observe the information ⇒  in *Wi-Fi hotspot on page 202*.

### Directory

Applies to: vehicles with telephone

*You can display the contacts from (other) mobile phones.*

Important: No mobile phones are connected to the MMI via the Bluetooth remote SIM Access Profile or the **Handsfree** profile.

- **Connect new device:** You can search for and connect a new mobile phone. **Or:** Slide your own mini SIM card into the slot in the SIM card reader\* until you feel it engage ⇒ *page 176, Fig. 160*.
- **List of devices already bonded:** Select your mobile phone from the list of all mobile phones which have already been bonded.

### Audi smartphone

Applies to: vehicles with Audi smartphone interface

- Connect your mobile phone to the Audi music interface ⇒ *page 241* via a USB adapter ⇒ *page 240, Fig. 196*.
- Select your mobile phone from the list of mobile phones already connected.

### Further options

Further options may be available in the connection manager via the right control button depending on the function selected.

#### Delete Bluetooth device\*

The selected mobile phone/mobile device will be disconnected from the MMI system and removed from the list of devices already connected.

#### Display Bluetooth profiles\*

You can **Connect** or **Disconnect** the **Handsfree, Car phone\***, **Messages\***, **Directory/contacts** and **Bluetooth audio player** profiles individually.

#### Bluetooth settings\*

- **Bluetooth:** Select and confirm a discoverability setting for the Bluetooth connection. Select **visible** to make the MMI visible to other devices. Select **invisible** to make the MMI invisible to other devices. Devices which have already been bonded can connect via Bluetooth even when discoverability is deactivated. Select **off** to switch discoverability off. It is then not possible to establish a Bluetooth connection.
- **Bluetooth audio player:** When this function is switched on , the Bluetooth audio player is available as a source in the **Media** menu.
- **Bluetooth name:** The Bluetooth name of the MMI system (e.g. "AUDI MMI 2017") is displayed and can be changed.

#### Online settings\*

- **Data connection settings:** Refer to ⇒ *page 203, Configuring the data connection*.
- **Data usage meter:** The number of the data packets sent/received via the MMI system is displayed. Select **Reset data meter** to reset the usage statistics to zero.
- **Connection status:** The mobile network provider for data services and the network status are displayed.

#### Wi-Fi settings\*

Refer to ⇒ *page 201, Wi-Fi hotspot*. ▶

## Store as default telephone

Applies to: vehicles with telephone

**Important:** A mobile phone must be connected to the MMI system ⇒ *page 173*.

This mobile phone will be prioritised over other Bluetooth devices and connected as soon as it is within range. For this to occur, the Bluetooth function of both the mobile phone and the MMI must be switched on. The connected mobile phone is shown at the top of the device list.

## SIM PIN settings\*

Applies to: option using your own SIM card

- **Automatic PIN entry:** When this function is switched on , the SIM PIN is stored in the MMI after it has been entered for the first time. You can save the PIN codes of four different SIM cards on the MMI. If this function is switched off , the PIN currently stored in the MMI will be deleted. If the automatic PIN entry function is activated, the system does not ask you to enter your SIM PIN explicitly.
- **Deactivate PIN query:** The system does not ask for the SIM PIN when you switch it on. The automatic PIN entry function is ignored in this case.
- **Change PIN:** You can change the PIN code for your SIM card. First enter the existing PIN code for your SIM card. The SIM PIN code can only consist of numbers from 0 to 9. The new SIM PIN code has to be entered twice, as a precautionary measure, and is stored on the SIM card.

## Network settings\*

- **Registration:** To dial into your service provider's mobile network **automatically** or to select a network **manually** from the list of available networks.
- **Network selection:** You can use this function to select the available networks for the current position of the vehicle. This function is only available when the **manual** setting is activated for registration.

## Apple CarPlay sound settings/Android Auto sound settings

Applies to: vehicles with Audi smartphone interface

Refer to ⇒ *page 260*.

## About Apple CarPlay/About Android Auto

Applies to: vehicles with Audi smartphone interface

Here you will find legal information about using Apple CarPlay/Android Auto and information about data transfer for specific devices.

## Delete CarPlay device/Delete Android Auto device

Applies to: vehicles with Audi smartphone interface

**Important:** Your mobile phone must no longer be connected to the Audi music interface via a USB adapter.

To remove your mobile phone from the list of mobile phones already connected, select and confirm **Delete CarPlay device** or **Delete Android Auto device**.

### Note

Some SIM cards do not allow the SIM PIN query to be deactivated.

## System update

- ▶ Select: **MENU** button > **Settings** > left control button > **System maintenance**.
- **System update:** Insert the storage medium with the update data into the appropriate drive ⇒ *page 235*. Select and confirm the appropriate drive > **Start update**. The duration of this process depends on the size of the update.
- **Reset driver installation:** The media driver package selected is reset to the factory defaults.
- **Version information:** Information on the software version of the MMI and the navigation database\* is displayed. In addition, you can use the **Software information** function to display information on the MMI's software and licence conditions.

# On-board Handbook

Applies to: vehicles with On-board Handbook

*The On-board Handbook includes the Owner's Manual for your vehicle.*

## Installing/updating the On-board Handbook

Important: The storage medium on which the On-board Handbook is stored must have been inserted into the relevant drive ⇒ *page 235*.

- ▶ Select: **MENU** button > **Settings** > left control button > **System maintenance** > **System update** > **SD card 1, SD card 2, CD/DVD\*** or **USB\***.
- ▶ Follow the instructions given by the system.

## Starting the Handbook

Important: The Handbook must have been installed previously.

- ▶ Select: **MENU** button > **Car** > left control button > **Handbook**.

The On-board Handbook will automatically load in the language that is set under the option Menu language in the MMI ⇒ *page 255*.

## Using the On-board Handbook

The following functions are available when you are operating the On-board Handbook using the rotary pushbutton:

- **Select and confirm an entry:** Turn the rotary pushbutton to the entry you require and press the rotary pushbutton.
- **Show a picture in full size:** Turn the rotary pushbutton to the desired picture and press the rotary pushbutton.
- **Call up the options menu:** You can use the right control button to return to the **Home** page and open the **Index**.

### **WARNING**

You should only use the On-board Handbook when the traffic conditions allow you to do so safely and when you can maintain proper control of your vehicle - risk of injury.

### **Note**

– The On-board Handbook is not available in all countries. Your Audi dealer will be able

to provide you with more detailed information.

- Switch off the ignition while you are installing/updating the On-board Handbook.
- Please note that the On-board Handbook is not a substitute for the printed Owner's Manual.

# Sound settings

*You can adjust the sound and volume of the MMI individually. The settings depend on the equipment fitted in your vehicle.*



Fig. 206 Adjusting balance/fader\*

- ▶ Select: **MENU** button > **Sound** > left control button > **Entertainment**.

## Treble / Bass

You can adjust the settings for **Treble** and **Bass** by turning the rotary pushbutton. Any changes to the settings only apply to the audio source currently active. This allows you to set the sound for each audio source separately.

## Balance/fader\* (sound focus)

- **To set the left/right volume ratio:** Press the rotary pushbutton. Turn the rotary pushbutton clockwise or anti-clockwise to the desired position.
- **To set the front/rear volume ratio\*:** Press the rotary pushbutton again. Turn the rotary pushbutton clockwise or anti-clockwise to the desired position.
- **To set the volume ratio using the MMI touch pad\*:** Move your finger in the desired direction on the MMI touch pad. ▶



## Sound effects

Select and confirm a setting for **Focus**:

- **all**: All the loudspeakers in the vehicle are active (evenly distributed sound focus).
- **front**: Only the loudspeakers in the front of the vehicle are active.
- **rear\***: Only the loudspeakers in the rear of the vehicle are active.

## Surround level

You can adjust the surround sound by turning the rotary pushbutton.

## Subwoofer\*

You can adjust the subwoofer by turning the rotary pushbutton.

## Speed-dependent volume control

You can adjust the automatic volume adaption to the interior noise level by turning the rotary pushbutton.

# Volume settings

## Adjusting the volume

Using the ON/OFF button, you can adjust the volume of an audio source or system message (e.g. during a speech dialogue\*) directly while it is being played.

- **Volume up/down**: Turn the ON/OFF button ① ⇒ page 152, Fig. 141 clockwise or anti-clockwise.
- **Mute/pause**: Briefly press the ON/OFF button. **Or**: Turn the ON/OFF button anti-clockwise until the symbol ⑫ ⇒ page 161 appears. Any active audio/video source will then be paused.
- **Unmute/resume**: Briefly press the ON/OFF button. **Or**: Turn the ON/OFF button clockwise.

## WARNING

The audio system volume should be set at a level which enables you to hear external signals (such as the sirens of police and emergency vehicles) clearly – failure to do so could result in an accident.

## Note

When you switch on the MMI system, very high/very low volume levels are automatically reduced/increased to a preset level.

## Setting the system volume

- ▶ Select: MENU button > **Sound** > left control button.

## Telephone

Applies to: vehicles with telephone

**Mute telephone**: Message and ring tones are silenced.

**Ring tone**: Refer to ⇒ page 188, **Ring tone and volume settings**.

**Ring tone volume**: You can adjust the volume of the ring tone currently selected by turning the rotary pushbutton.

**Message volume**: You can adjust the volume of the tone informing you of a new message by turning the rotary pushbutton.

**Microphone input level**: You can adjust the telephone volume during a call by turning the rotary pushbutton.

## Navigation

Applies to: vehicles with navigation system

**Voice guidance**: Refer to ⇒ page 218.

**Voice guidance during calls**: Refer to ⇒ page 218.

**Volume of spoken cues**: You can adjust the volume of the spoken cues by turning the rotary pushbutton. **Or**: You can adjust the volume of the spoken cues while route guidance is active by turning the ON/OFF button.

**Entertainment fader**: This option allows the volume of the current audio source to be temporarily reduced when the parking aid is active or while a navigation cue is being played.

## Announcements\*

**Traffic announcements**: Refer to ⇒ page 229.

**DAB announcements\***: Refer to ⇒ page 229. ▶

**Volume of announcements:** You can adjust the volume of traffic announcements by turning the rotary pushbutton.

### Speech dialogue system

Applies to: vehicles with speech dialogue system

**Command display:** Refer to ⇒ page 256.

**Short dialogue:** Refer to ⇒ page 256.

**Volume:** Refer to ⇒ page 256.

**Individual speech training:** Refer to ⇒ page 256.

### Parking aid\*

You can adjust the volume of the sounds by turning the rotary pushbutton.

- **To adjust the front volume:** Select and confirm **high, medium** or **low**.
- **To adjust the rear volume:** Select and confirm **high, medium** or **low**.

### MMI touch\*

You can adjust the volume of the MMI touch\* spoken cues by turning the rotary pushbutton.

## Restarting the MMI system

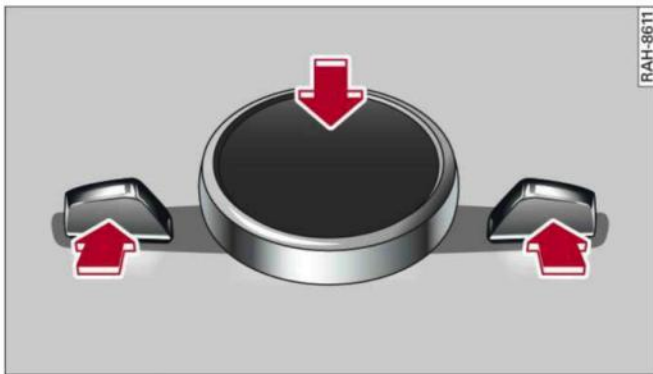

Fig. 207 Combination of buttons for restart

- Briefly press the rotary pushbutton and *simultaneously* press the two buttons for calling up menus directly upwards ⇒ Fig. 207.

## Notes on software licences

### Information on the MMI system's software and its licence conditions

- Select: **MENU** button > **Settings** > left control button > **System maintenance** > **Version information**.
- **Or:** On the Internet at [www.audi.com/softwareinfo](http://www.audi.com/softwareinfo).

### Information on the head-up display's software and its licence conditions

- Important: The vehicle must be stationary.
- After switching on the ignition, press and hold the button for the head-up display for at least five seconds .
- Press the rotary pushbutton to close the information box. **Or:** Drive off.

### Information on the instrument cluster's software and its licence conditions

Press the reset button  ⇒ page 12, Fig. 4 twice in the first five seconds after switching on the ignition.

## Safe driving

### General notes

#### Safety is the first priority

The safety features in your vehicle are harmonised to provide you and your passengers with the best possible protection in accident situations. However, they can only be effective if you and your passengers sit in the correct position and adjust and use the safety equipment properly.

For these reasons, this chapter explains why these safety features are so important, how they can protect you, what you need to remember when using them, and how you and your passengers can gain the most benefit from them. There are also a number of important safety warnings which you and your passengers should always observe in order to minimise the risk of injury.

#### WARNING

- The information in this chapter is important for the driver of the vehicle and all passengers. The other chapters in this manual (and, where applicable, in the other literature supplied with the vehicle) contain further important notes which you should read and observe for your own safety and that of your passengers.
- Ensure that the complete vehicle wallet is always in the vehicle. This is especially important when you lend or sell the vehicle to others.

#### Before every trip

*The driver is responsible for the safety of the passengers and the safe operation of the vehicle at all times.*

For your own safety and the safety of your passengers, always note the following points before every trip:

- ▶ Make sure that all lights and turn signals are working properly.
- ▶ Check the tyre pressures.
- ▶ Make sure that all windows are clean and give good visibility to the outside.

- ▶ Secure all luggage and other items carefully ⇒ *page 272*.
- ▶ Make sure that no objects can interfere with the pedals.
- ▶ Adjust the front seat, head restraint and mirrors correctly.
- ▶ Applies to: adjustable head restraints: Make sure that the front passenger's head restraint is adjusted to the correct position.
- ▶ Applies to: adjustable head restraints: Make sure that the head restraints for the rear passengers are in the fully raised position.
- ▶ Make sure that children are protected with suitable safety seats and properly worn seat belts ⇒ *page 267*.
- ▶ Sit in the correct position in your seat. Make sure that your passengers are sitting in the correct positions ⇒ *page 58*.
- ▶ Fasten your seat belt correctly. Make sure that your passengers do the same ⇒ *page 275*.

#### What factors can impair your safety?

*Safety on the road is directly related to how you drive, and can also be affected by the passengers in the vehicle.*

- ▶ The driver is responsible for the safety of the vehicle and all its occupants. If your ability to drive is impaired in any way, you endanger yourself and other road users ⇒ . Therefore:
- ▶ Do not let yourself be distracted by passengers or by using a mobile phone, etc.
- ▶ Never drive when your driving ability is impaired (by medication, alcohol, drugs, etc.).
- ▶ Obey all traffic regulations and speed limits and always maintain a safe distance to the vehicle in front.
- ▶ Always adjust your speed to suit the road, traffic and weather conditions.
- ▶ Take frequent breaks on long trips. Do not drive for more than two hours without a stop.
- ▶ If possible, avoid driving when you are tired or stressed.



### WARNING

- Distractions while driving or any kind of impairment to your driving ability increase the risk of accident and injury.
- Do not place loose objects on the dash panel. These objects could fly around the interior when the vehicle is moving (under acceleration or whilst cornering) and distract the driver – risk of accident!

## Correct sitting positions

### Correct driving position

The correct driving position is important for safe driving.

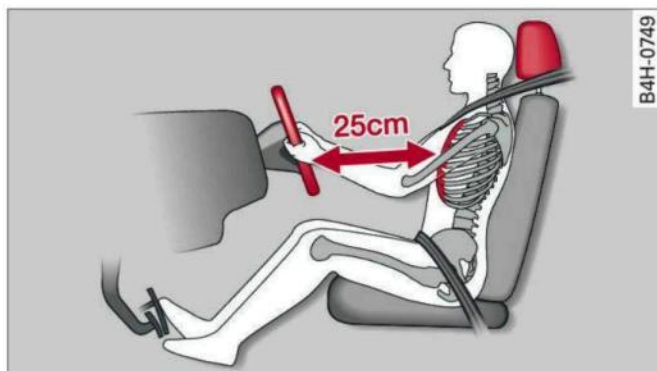

Fig. 208 Adjust seat and sit in correct position

For your own safety, and to reduce the risk of injury in the event of an accident, we recommend the following driving position.

- ▶ Adjust the driver's seat and steering wheel so there is a distance of at least 25 cm between your breastbone and the centre of the steering wheel ⇒ Fig. 208.
- ▶ Adjust the height and fore/aft position of the driver's seat so that you are able to press the pedals to the floor without fully straightening your legs ⇒ ⚠.
- ▶ Adjust the backrest to an upright position so that your back remains in contact with the upholstery.
- ▶ Adjust the longitudinal position of the steering wheel so that your arms are slightly bent and you can read the dials and instruments easily.
- ▶ Make sure that you can comfortably reach the top of the steering wheel.
- ▶ Applies to adjustable head restraints: Adjust the head restraint so that the top of the head restraint is level with the top of your head. If this is not possible, try to adjust the head restraint as near as possible to this position.
- ▶ Fasten your seat belt correctly ⇒ page 275.
- ▶ Keep both feet in the footwell so that you are in full control of the vehicle at all times.

For detailed information on how to adjust the driver's seat, see ⇒ page 58, *Front seats*.

### ⚠ WARNING

A driver who is not sitting in the correct position or who is not wearing a seat belt can be fatally injured if the airbag is triggered.

- Adjust the driver's seat and steering wheel so there is a distance of at least 25 cm between your breastbone and the centre of the steering wheel ⇒ Fig. 208.
- While driving, always hold the steering wheel with both hands on the outside of the rim at about the 9 o'clock and 3 o'clock position. This reduces the risk of injury if the driver's airbag inflates.
- Never hold the steering wheel at the 12 o'clock position, or with your hands inside the rim or on the steering wheel hub. This could result in serious injuries to the arms, hands and head if the driver's airbag inflates.
- To reduce any risk of injury to the driver during a sudden brake application or in an accident, never drive with the backrest tilted too far back. The airbag system and seat belts can only provide proper protection when the backrest is in an upright position and the driver is wearing the seat belt in the correct position. The further the backrest is tilted back, the greater the risk of injury due to incorrect positioning of the belt webbing or an incorrect sitting position.
- Adjust the head restraint properly so that it can give maximum protection.

### Correct position for the front passenger

The front seat passenger must sit at least 25 cm away from the dash panel so that the airbag has enough room to inflate and give maximum protection in an accident.

For your own safety and to reduce the risk of injury in the event of an accident, we recommend adjusting the front passenger's seat as follows:

- ▶ Adjust the backrest to an upright position so that your back remains in contact with the upholstery.
- ▶ Adjust the head restraint so that the top of the head restraint is level with the top of your

head. If this is not possible, try to adjust the head restraint as near as possible to this position.

- ▶ Keep both feet in the footwell in front of the seat.
- ▶ Fasten your seat belt correctly ⇒ *page 277*.

In **exceptional cases** you can disable the front passenger's airbag via the key-operated switch\* ⇒ *page 288*.

For detailed information on how to adjust the front passenger's seat, see ⇒ *page 58, Front seats*.

### WARNING

- A passenger who is not sitting in the correct position or who is not wearing a seat belt can be fatally injured if the airbag is triggered.
- Adjust the front passenger's seat so there is a distance of at least 25 cm between your breastbone and the dash panel.
  - Always keep your feet on the floor when the vehicle is moving; never rest them on the instrument panel, out of the window or on the seat. If you sit in an incorrect position, you increase your risk of injury in the event of sudden braking or an accident. If the airbag is triggered, you could sustain potentially fatal injuries by sitting out of position.
  - To reduce the risk of injury to the front passenger in the case of sudden braking or an accident, the passenger should never travel in a moving vehicle with the backrest reclined. The airbag system and seat belt can only provide proper protection when the backrest is in an upright position and the passenger is wearing the seat belt in the correct position. The further the backrest is tilted back, the greater the risk of injury due to incorrect positioning of the belt webbing or an incorrect sitting position.
  - Always adjust the head restraints properly for maximum protection.

### Correct position for rear passengers

*Rear seat passengers should sit upright with both feet on the floor and wear their seat belts properly whenever the vehicle is moving.*

To reduce any risk of injury in the event of sudden braking or an accident, passengers in the rear seats must observe the following:

- ▶ Before carrying passengers on the rear seats, pull the head restraints on the occupied seats all the way up ⇒ *page 59*.
- ▶ Keep both feet in the footwell in front of the rear seat.
- ▶ Fasten your seat belt correctly ⇒ *page 278*.
- ▶ Use appropriate child restraint systems for children travelling in the vehicle ⇒ *page 267*.

### WARNING

Rear passengers sitting out of position can suffer severe injuries.

- Always adjust the head restraints to the fully raised position for maximum protection.
- Seat belts only offer maximum protection when the backrest is in an upright position and the passengers are wearing the seat belts properly. By not sitting upright, rear passengers increase the risk of injury due to incorrect positioning of the seat belt webbing.

### Correct adjustment of head restraints

*Properly adjusted head restraints are an important part of the vehicle's occupant protection system. They can help to reduce the risk of injuries in most accident situations.*

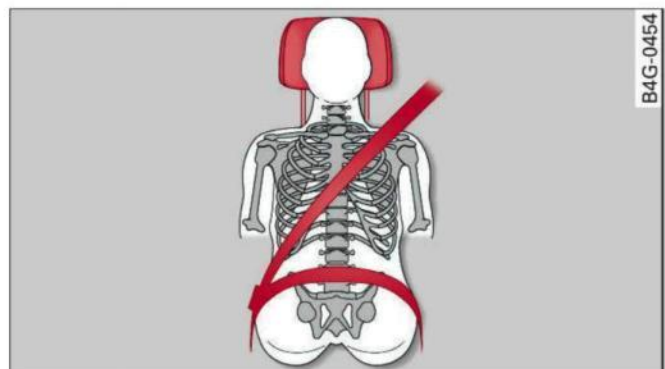

Fig. 209 Head restraint (seen from the front)

The head restraints must be adjusted properly to provide maximum protection.

- ▶ Adjust the front head restraints so that the top of the head restraint is level with the top of your head. If this is not possible, try to adjust the head restraint as near as possible to this position.
- ▶ Before carrying passengers on the rear seats, pull the head restraints on the occupied seats all the way up ⇒ *page 59*.

For more information on how to adjust the head restraints, see ⇒ *page 58*.

### WARNING

- Travelling with the head restraints removed or incorrectly adjusted increases the risk of severe injuries.
- Incorrectly adjusted head restraints can also increase the risk of injury during sudden or unexpected braking or other manoeuvres.

### Examples of incorrect seating positions

*Occupants can suffer severe or fatal injuries if they sit in an incorrect position while the vehicle is moving.*

Seat belts can only provide maximum protection if the belt webbing is positioned correctly. Sitting out of position greatly reduces the effectiveness of the seat belts and increases the risk of injury since the belt webbing is not worn in the position for which it is designed. The driver is responsible for the safety of all vehicle occupants, especially for children.

- ▶ Never allow anyone to sit out of position while the vehicle is moving ⇒ .

The following list shows just some examples of incorrect sitting positions which can be dangerous to all occupants. The list is not complete, but will help to make you aware of possible dangers which can be avoided.

#### Therefore, whenever the vehicle is moving:

- Never stand up in the vehicle.
- Never stand on the seats.

- Never kneel on the seats.
- Never travel with the backrest reclined too far.
- Never lean against the dash panel.
- Never lie down on the rear seat.
- Never sit on the front edge of a seat.
- Never sit sideways.
- Never lean out of the window.
- Never put your feet out of the window.
- Never put your feet on the dash panel.
- Never put your feet on the seat cushion.
- Never ride in the footwell.
- Never travel on a seat without wearing the seat belt.
- Never climb into the luggage compartment.

### WARNING

Sitting out of position increases the risk of severe injuries.

- Sitting out of position exposes the occupants to potentially fatal injuries if, for instance, the airbags inflate and strike an occupant who is not seated in one of the proper positions.
- Before starting a trip, sit in the correct position and stay in this position as long as the vehicle is moving. Before every trip, make sure all passengers are sitting in the correct positions and remain correctly seated at all times ⇒ *page 58, Front seats*.

## Child seats

### Safety notes for using child seats

*To reduce the risk of injury in the event of an accident, children must always use child restraint systems when travelling in the car.*

Please note the information in this Owner's Manual when installing and using child seats. Follow the manufacturer's instructions and observe any statutory requirements.

For safety reasons, we recommend that child seats be installed on the rear seats. You should only use a child seat on the front passenger seat in exceptional circumstances. ▶

**! WARNING**

To avoid serious or fatal injury, children travelling in the vehicle must always be protected with child restraint systems appropriate to their height, weight and age.

- Children under 1.50 m tall or younger than 12 must not travel in the vehicle if there are no suitable child seats. Please observe any other applicable regulations in the country in which you are travelling.
- Babies and children must never travel on another occupant's lap.
- Never allow more than one child to occupy one child seat.
- Never leave a child without supervision in a child seat.
- Never allow a child to travel unrestrained or to stand up or kneel on a seat while the car is moving. In an accident, the child could be catapulted through the car, causing possibly fatal injuries to itself and other occupants.
- To ensure proper protection by the child restraint, it is important to wear the seat belts in the correct position ⇒ *page 277*. Always check that the belt is properly positioned according to the instructions provided by the manufacturer of the child seat. Incorrectly worn seat belts can give rise to injuries even in a minor collision.
- If children are out of position when the car is moving, they are at greater risk of injury during a sudden braking manoeuvre or in an accident. This is particularly the case if the child is travelling on the front passenger's seat and the airbag system is triggered in an accident. This incorrect sitting position can result in serious or even fatal injury.
- Make sure there is sufficient clearance in front of the child sitting in the child seat. If necessary, adjust the seat position and backrest angle of the seat in front of the child seat.
- If you are using a child seat on the front passenger seat in which the child faces the direction of travel, you should move the front passenger seat as far back as possible.

- Child seats in which the child faces the rear of the car are located directly in the path of the front passenger's airbag if it inflates. In this case, the child could sustain serious or fatal injuries if the airbag were to be deployed.
- Applies to vehicles on which the front passenger's airbag cannot be deactivated: Do NOT use a rearward-facing child seat on the front passenger's seat.
- Applies to vehicles with key-operated switch for deactivating the front passenger's airbag: Do NOT use a rearward-facing child seat on the front passenger's seat while the front passenger's airbag is active. If you have no alternative but to use a rearward-facing child seat on the front passenger's seat, the front passenger's airbag must be deactivated beforehand via the key-operated switch\* ⇒ *page 288*. Make sure that the front passenger's airbag is reactivated by means of the key-operated switch\* as soon as the child seat is no longer needed on the front passenger's seat.
- Always replace the child seat with a new one after an accident as damage not externally visible may have occurred.

**Child seat categories**

*Only use child restraint systems that are officially approved and suitable for the child.*



**Fig. 210** Weight categories for child seats



Child restraint systems are regulated by European standards ECE R 44 or ECE-R 129<sup>1)</sup>. Both standards apply in parallel. An orange label is normally attached to child seats which have been tested in accordance with these standards. Information on weight categories, ISOFIX size class and the approval category of the child seat can be found on this label.

### Weight categories for child seats

- **Child seats: categories 0 and 0+:** Rearward-facing carry cots are most appropriate for these categories (up to 13 kg). Our recommendation: Audi carry cot with optional ISOFIX base.
- **Child seats: category 1:** In this category (9 to 18 kg), rearward or forward-facing child seats with an integrated seat belt system are most appropriate. Rearward-facing child seats should be used for as long as safely possible. Our recommendation: Audi child seat with ISOFIX base.
- **Child seats: categories 2 and 3:** Child seats with backrests used in conjunction with seat belts are most appropriate for these categories (15 to 36 kg). Our recommendation: Audi child seat "youngster plus".

### Approval categories for child seats

Child seats can have the approval categories universal, semi-universal, vehicle-specific (all according to the ECE-R 44 standard) or i-Size (according to the ECE-R 129 standard).

- **Universal:** Child seats approved for the universal category are suitable for installation in any vehicle. A model list is not required. Universal category child seats for ISOFIX anchorages must be secured additionally by a top tether strap.
- **Semi-universal:** Safety appliances requiring additional tests are required for securing a child seat with semi-universal approval. Child seats with semi-universal approval have a model list which must include your vehicle.
- **Vehicle-specific:** Vehicle-specific approval requires that the child seat undergo a separate

dynamic test for each vehicle model. Child seats with a vehicle-specific approval also have a model list.

- **i-Size:** Child seats with i-Size approval must comply with the installation and safety requirements specified in the ECE-R 129 standard. Your child seat manufacturer can inform you which child seats with i-Size approval are appropriate for your vehicle.

### WARNING

- Rearward-facing child seats: Never install a rearward-facing child seat on the front passenger's seat unless the front passenger's airbag has been deactivated – this can result in potentially fatal injuries to the child. If you have no alternative but to let a child travel on the front passenger's seat, the front passenger's airbag must be deactivated\* beforehand ⇒ *page 288*.
- Forward-facing child seats: The back of the child seat should be flush with the backrest of the vehicle seat. If the rear head restraint obstructs you when installing the child seat, adjust or remove it completely ⇒ *page 59*. Install the head restraint again immediately after removing the child seat. Adjust the head restraint to the correct height for the passenger. Travelling with the head restraints removed or incorrectly adjusted increases the risk of severe injuries.
- Categories 2 and 3: The shoulder section of the belt must be fitted across the centre of the child's collar bone close to the torso. It must never run against or across the neck. The lap belt must be worn tightly across the hips, and not over the stomach or abdomen. Pull the belt tight if necessary to take up any slack.
- Wait for as long as possible before changing up to the next child seat group.

### Note

We recommend child seats from the range of Audi Genuine Accessories: [www.audi.com](http://www.audi.com).

<sup>1)</sup> The ECE-R 129 standard has not yet been implemented by the national authorities in all countries.

## Fitting child seats

### Securing child seats with ISOFIX

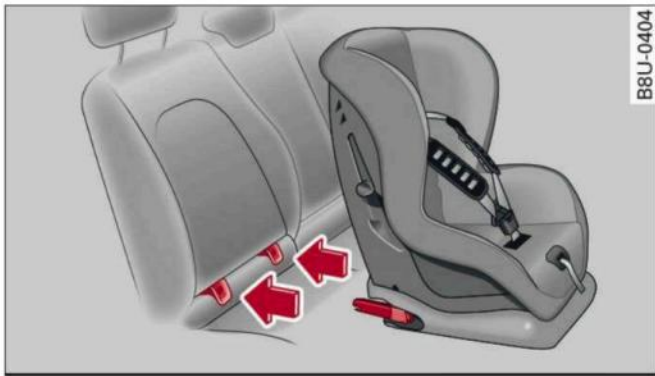

Fig. 211 Securing child seat with ISOFIX

If you wish to attach an ISOFIX child seat or i-Size child seat to the ISOFIX anchorages in your vehicle, please ensure that it is approved for the seats in your vehicle. The following table ⇒ *table on page 270* shows the installation options. The necessary information can be found on the orange label on the child seat.



- ▶ Remove the covers\* from the two ISOFIX anchorages.
- ▶ Push the mountings on the child seat into the ISOFIX anchorages until they engage audibly ⇒ *Fig. 211*.
- ▶ Pull on the child seat to check whether both sides have engaged properly.
- ▶ If possible, secure the child seat additionally to the top tether<sup>1)</sup> anchorage ⇒ *page 271*.

| Child seat                         | ISOFIX size category | Outer rear seats | Front passenger's seat* |
|------------------------------------|----------------------|------------------|-------------------------|
| <b>Category 0:</b><br>up to 10 kg  | E                    | IL               | IL                      |
| <b>Category 0+:</b><br>up to 13 kg | E                    | IL               | IL                      |
|                                    | D                    |                  |                         |
| <b>Category 1:</b><br>9 to 18 kg   | C                    | IL, IUF          | IL                      |
|                                    | D                    |                  |                         |
|                                    | C                    |                  |                         |
|                                    | B                    |                  |                         |
|                                    | B1                   |                  |                         |
|                                    | A                    | IL, IUF          |                         |

| Child seat                        | ISOFIX size category | Outer rear seats | Front passenger's seat* |
|-----------------------------------|----------------------|------------------|-------------------------|
| <b>Category 2:</b><br>15 to 25 kg | -                    | IL               | IL                      |
| <b>Category 3:</b><br>22 to 36 kg | -                    | IL               | IL                      |
| <b>i-Size child seat</b>          | -                    | i-U              | X                       |

- **Size category:** The size category specifies the weight range for which the seat is approved. On child seats with universal or semi-universal approval, the size category is specified on the ECE approval label. Each child seat carries a label specifying the weight category.
- **IL:** Seat suitable for the attachment of an ISOFIX child seat with semi-universal approval. Refer to the list of vehicles provided by the child seat manufacturer.
- **IUF:** Seat suitable for the attachment of a forward-facing ISOFIX child seat with universal approval.
- **i-U:** Seat suitable for the attachment of an i-Size child seat with universal approval.
- **X:** Seat not suitable for the attachment of the corresponding child seat.

#### WARNING

- Please refer to the important safety notes ⇒  in *Safety notes for using child seats on page 268*, ⇒  in *Child seat categories on page 269* and the instructions provided by the child seat manufacturer.
- Never install a rearward-facing child seat on the front passenger's seat unless the front passenger's airbag has been deactivated – this can result in potentially fatal injuries to the child.
- The anchorages in the vehicle are designed only for child seats with ISOFIX. Do not attempt to secure other types of child seat, seat belts or other objects to these anchorages - this could result in serious or possibly fatal injury.

<sup>1)</sup> This function is not available for all export versions.

### Securing child seats with ISOFIX and top tether

Applies to: vehicles with top tether



Fig. 212 Rear backrest: Top tether anchorages (version 1)



Fig. 213 Rear backrest: Top tether anchorages (version 2)

- ▶ Adjust the head restraint behind the child seat to the fully extended position.

- ▶ Push the mountings on the child seat into the ISOFIX anchorages until they engage audibly ⇒ page 270.
- ▶ Pull on the child seat to check whether both sides have engaged properly.
- ▶ Guide the top tether strap of the child seat **underneath** or **past both sides** of the head restraint (depending on the type of child seat) towards the rear.
- ▶ Hook the strap into the top tether anchorage<sup>1)</sup> ⇒ Fig. 212 / ⇒ Fig. 213.
- ▶ Pull the tether strap tight so that the top of the child seat rests securely against the backrest.

#### ⚠ WARNING

- Please refer to the important safety notes ⇒ ⚠ in *Safety notes for using child seats* on page 268, ⇒ ⚠ in *Child seat categories* on page 269 and the instructions provided by the child seat manufacturer.
- The anchorages in the vehicle are designed only for one child seat with ISOFIX and top tether. Do not attempt to secure other types of child seat, seat belts or other objects to these anchorages - this could result in serious or possibly fatal injury.

### Securing child seats with seat belt

If you wish to use a child seat in the approval category “universal” (u), please ensure that it is approved for the seats in your vehicle. The follow-

ing table shows the installation options. The necessary information can be found on the orange label on the child seat.

| Weight class             | Front passenger's seat      |                               | Outer rear seat positions | Centre rear seat position* |
|--------------------------|-----------------------------|-------------------------------|---------------------------|----------------------------|
|                          | Front passenger's airbag on | Front passenger's airbag off* |                           |                            |
| Category 0: Up to 10 kg  | X                           | u                             | u                         | u                          |
| Category 0+: Up to 13 kg | X                           | u                             | u                         | u                          |
| Category 1: 9 to 18 kg   | X                           | u                             | u                         | u                          |
| Category 2: 15 to 25 kg  | u                           | u                             | u                         | u                          |
| Category 3: 22 to 36 kg  | u                           | u                             | u                         | u                          |



X: Seat not suitable for the attachment of the corresponding child seat.

To adjust the front passenger's seat to the child seat and to achieve the best possible seat belt

<sup>1)</sup> Two or three top tether anchorages are provided, depending on the equipment installed in your vehicle.

positioning, move the front passenger's seat as far upwards as possible using the seat's height adjustment. After installing the child seat on the front passenger's seat, move the front passenger's backrest forward until it makes contact with the child seat.

### WARNING

- Please refer to the important safety notes ⇒  in *Safety notes for using child seats on page 268*, ⇒  in *Child seat categories on page 269* and the instructions provided by the child seat manufacturer.
- Never install a rearward-facing child seat on the front passenger's seat unless the front passenger's airbag has been deactivated – this can result in potentially fatal injuries to the child.

## Pedal area

### Pedals

*The pedals must always be free to move and must never be obstructed by floor mats or any objects in the footwell.*

- ▶ Make sure that none of the pedals is obstructed and all of the pedals can be pressed all the way down to the floor.
- ▶ Make sure that all pedals are able to return freely to their original positions.

Only use floor mats which leave the pedal area free and can be securely fastened in the footwell.

If one of the brake circuits should fail, increased brake pedal travel will be required to bring the vehicle safely to a stop.

### WARNING

- Any obstructions that restrict pedal travel can cause loss of vehicle control and lead to critical traffic situations.
- Never place objects in the driver's footwell. Such objects could move under the pedals and interfere with their proper function. In the event of sudden braking or a change of direction, you would not be able to use the

pedals. This could result in a loss of control and possibly cause an accident.

### Floor mats on the driver's side

*Use only floor mats which can be securely fastened in the footwell and do not obstruct the pedals.*

- ▶ Make sure that floor mats are securely fastened and cannot interfere with the pedals ⇒ .

Use only floor mats that leave the pedal area unobstructed and are firmly secured to prevent them from slipping. You can obtain suitable floor mats from your dealer or a specialist retailer.

### WARNING

- Any obstructions that restrict pedal travel can cause loss of vehicle control and increase the risk of serious personal injury.
- Always make sure that floor mats are properly secured.
  - Never lay or install additional floor mats or other floor coverings over the existing floor mats; this would restrict the pedal area and possibly obstruct the pedals, which could cause an accident.

## Stowing luggage safely

### Luggage compartment

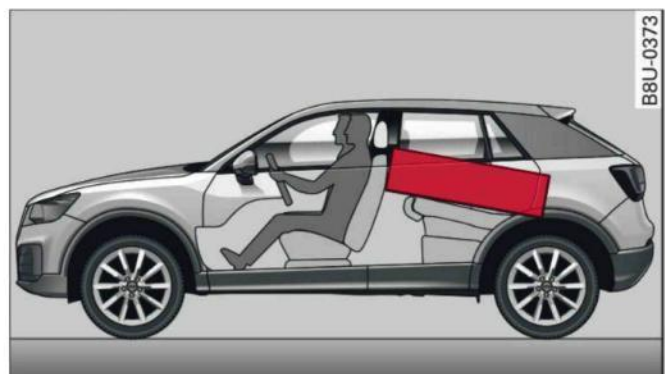

**Fig. 214** Heavy items should be placed as far forwards as possible (example).

All luggage and other objects must be safely secured in the luggage compartment. To maintain safe handling on the road, please observe the following points: ▶

- ▶ Distribute the load evenly in the luggage compartment.
- ▶ Place heavy items as far forward as possible in the luggage compartment and secure them properly ⇒ *Fig. 214*.
- ▶ Secure the load with the stretch net\* or with non-elastic straps secured to the fastening rings ⇒ *page 62*.

### WARNING

- Loose items in the luggage compartment are a safety hazard: they can move suddenly and impair the handling of the vehicle as a result of the change in weight distribution.
- In an accident or a sudden manoeuvre, loose objects in the passenger compartment can be flung forward – risk of injury! Always stow objects safely in the luggage compartment and secure them on the fastening rings. Use suitable securing straps, particularly when transporting heavy objects.
- Transporting heavy objects may affect the vehicle's handling by shifting the centre of gravity – this could cause an accident. Take extra care when driving and adjust your speed accordingly.
- Never exceed the maximum axle loads or the maximum gross weight for the vehicle ⇒ *page 342*. Exceeding the permitted axle loads or gross weight limit can affect the vehicle's handling characteristics, and increase the risk of accidents, personal injuries or damage to the vehicle.
- Never leave your vehicle unattended when the boot lid is open. Children could climb into the boot and close the boot lid from the inside. In this case the child would be unable to get out of the vehicle without help. This could have fatal consequences.
- Never allow children to play in or around the vehicle. Always close and lock the boot lid and all the doors when you leave the vehicle.
- Never let passengers ride in the luggage compartment. All occupants must be properly restrained by the seat belts at all times ⇒ *page 275*.

### CAUTION

Make sure that no hard objects chafe against the wires of the heating element in the rear window and damage them.

### Note

- The tyre pressure must be adjusted according to the load the vehicle is carrying ⇒ *page 307*.
- Air circulation in the vehicle helps reduce fogging of the windows. Used air escapes through ventilation slots in the rear of the vehicle. Make sure that these ventilation slots are not obstructed.
- Suitable belts for securing loads to the fastening rings\* are commercially available.

### Fastening rings

*Unsecured loads are a hazard to all vehicle occupants.*

There are fastening rings in the luggage compartment which can be used to secure luggage and other objects ⇒ *page 62*.

- ▶ Use the fastening rings to secure items safely in the luggage compartment ⇒ .

During a collision or an accident, even small and light objects can possess so much energy that they can cause very severe injuries. The amount of this “kinetic energy” depends on the speed of the vehicle and the weight of the object. The most significant factor, however, is the speed of the vehicle.

For example: an object weighing 4.5 kg is lying unsecured in the vehicle. During a frontal collision at a speed of 50 km/h, this object generates a force corresponding to 20 times its weight. That means that the effective weight of the object increases to about 90 kg. You can imagine the severity of the injuries which might be sustained if this “projectile” strikes an occupant as it flies through the passenger compartment. ▶

 **WARNING**

If items of luggage or other objects are secured to the fastening rings with inappropriate or damaged tensioning straps, injuries could result in the event of sudden braking or a collision.

- To prevent pieces of luggage or other objects from flying forward, always use appropriate tensioning straps which are properly secured to the fastening rings.
- Never secure a child seat on the fastening rings.

## Seat belts

### Why is it so important to use seat belts?

#### Seat belts provide effective protection

*The common belief that passengers can brace their weight with their hands in a minor collision is false.*



**Fig. 215** Driver with correctly positioned seat belt – good protection if the brakes are applied suddenly

It is an established fact that seat belts provide good protection in accidents. Therefore wearing a seat belt is required by law in most countries.

When worn correctly, seat belts hold the occupants in the best position for maximum protection ⇒ *Fig. 215*. The seat belts are capable of absorbing much of the kinetic energy which is generated in a collision. They also help to prevent uncontrolled movements which could lead to severe injuries ⇒ *page 275, Important safety notes when using seat belts*.

If they wear the seat belts correctly, the passengers benefit greatly from the ability of the belts to reduce the kinetic energy gradually. The front crumple zones and other passive safety features (such as the airbag system) are also designed to absorb the kinetic energy generated in a collision. Taken together, all these features reduce the forces acting on the occupants and consequently the risk of injury.

Although these examples are based on a frontal collision, the physical principles involved are the same in other types of accidents. This is why it is so important to put on the seat belts before every trip - even when “just driving around the cor-

ner”. Ensure that your passengers wear their seat belts as well ⇒ *⚠*.

Seat belts worn correctly have been shown to be an effective means of reducing the potential for injury and improving the chances of survival in a serious accident ⇒ *page 276, Forces acting in a collision*.

For information on how children can travel safely in the car refer to ⇒ *page 267, Child seats*.

#### **⚠ WARNING**

- Seat belts must be put on before every trip - even when driving in town. This also applies to the rear passengers – risk of injury!
- During pregnancy, women should always ensure they wear a seat belt. The best way to protect the unborn child is to protect the mother ⇒ *page 278, Wearing and adjusting the seat belts during pregnancy*.

#### Important safety notes when using seat belts

*There are a number of safety points concerning the seat belts which you should remember. This will help to reduce the risk of injury in an accident.*

#### **⚠ WARNING**

- The seat belts can only provide maximum protection if the seats are adjusted properly ⇒ *page 58, Front seats*.
- To ensure proper protection, it is important to wear the seat belts in the correct position ⇒ *page 277, How to wear seat belts properly*. Ensure that the seat belts are worn exactly as recommended in this chapter. Belts which are not worn properly can increase the risk of injury in accidents considerably.
- Do not allow the seat belt to become twisted or jammed, or to rub on any sharp edges.
- Never allow two passengers (even children) to share the same seat belt. It is especially dangerous to place a seat belt over a child sitting on your lap.

- Do not wear the belt over hard or fragile objects (such as glasses or pens, etc.) because this can cause injuries.
- Loose, bulky clothing (such as an overcoat over a jacket) impairs the proper fit and function of the belts.
- The belts must be kept clean, otherwise the retractors may not work properly  
⇒ *tab. Cleaning the interior on page 314.*
- The slot in the seat belt buckle must not be blocked with paper or other objects, as this can prevent the latch plate from engaging properly.
- The latch plate of the belt must always be engaged in the correct buckle for that seat, otherwise the belt will not be fully effective.
- Check the condition of the seat belts at regular intervals. If you notice that the belt webbing, fittings, retractor mechanism or buckle of any of the belts is damaged, the belt must be replaced by a qualified workshop.
- The seat belts must not be removed or modified in any way. Do not attempt to repair a damaged belt yourself.
- Seat belts which have been worn in an accident and stretched must be replaced by a qualified workshop. The belt anchorages should also be checked.

## Forces acting in a collision

### The physical principles involved in a frontal impact

*Very large forces are generated during a collision; these forces have to be absorbed.*

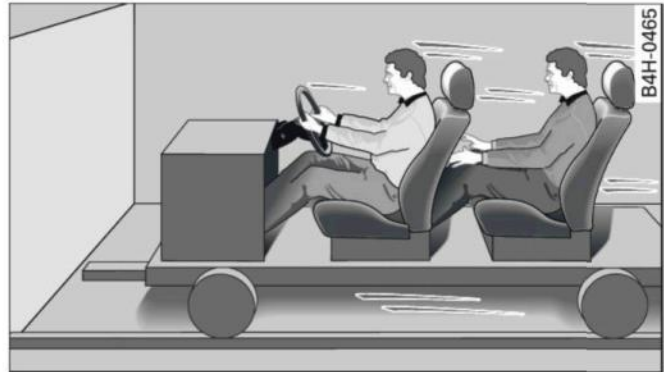

**Fig. 216** Passengers of a vehicle which is headed for a brick wall. They are not using seat belts.



**Fig. 217** The vehicle crashes into the wall

The physical principles involved in a frontal collision are relatively simple:

Both the moving vehicle and the passengers possess energy, which is known as “kinetic energy” ⇒ *Fig. 216*. The amount of “kinetic energy” depends on the speed of the vehicle and the weight of the vehicle and passengers. The higher the speed and the greater the weight, the more energy there is to be absorbed in an accident.

The most significant factor, however, is the speed of the vehicle. If the speed doubles from 25 km/h to 50 km/h, for example, the kinetic energy increases by a factor of four. Because these passengers are not restrained by seat belts, the entire amount of kinetic energy has to be absorbed at the point of impact ⇒ *Fig. 217*. This would result in serious or potentially fatal injury. ▶



Even at urban speeds of 30 km/h to 50 km/h, the forces acting on the occupants in a collision can reach the equivalent of 1 ton (1000 kg) or more. At greater speed these forces are even higher. Again: if the speed doubles, the forces increase by a factor of four.

Passengers who do not wear seat belts are not “attached” to the vehicle. In a frontal collision they will continue to move forward at the speed their car was travelling just before the impact.

**What happens to passengers not wearing seat belts?**

*Passengers not wearing seat belts risk fatal injuries in the event of an accident.*



**Fig. 218** A driver not wearing a seat belt can be thrown forwards

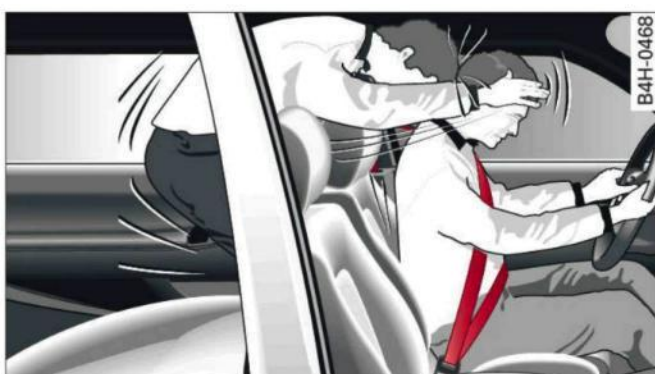

**Fig. 219** A rear passenger not wearing a seat belt can be thrown forwards

In a frontal collision, unbelted passengers will be thrown forwards and make violent contact with the steering wheel, dashboard, windscreen, etc ⇒ Fig. 218. Passengers not wearing their belts risk being thrown out of the car. This could result in potentially fatal injuries.

The common belief that occupants can brace their weight with their hands in a minor collision

is false. Even at low speeds the forces acting on the body in a collision are so great that it is not possible to hold yourself in the seat.

It is also important for the rear passengers to wear seat belts, as they could otherwise be thrown forwards violently in an accident. Rear passengers who do not use seat belts endanger not only themselves but also the other occupants ⇒ Fig. 219.

**How to wear seat belts properly**

**Putting on the three-point seat belts**

*Always fasten your seat belts before driving off.*



**Fig. 220** Positioning of head restraints and seat belts



**Fig. 221** Driver's seat: Belt buckle and latch plate

- ▶ Adjust the front seat and head restraint correctly before putting on the seat belt ⇒ page 58, *Front seats*.
- ▶ To fasten the belt, take hold of the belt and pull it evenly across your chest and lap ⇒ Fig. 221, ⇒ ⚠.
- ▶ Insert the latch plate into the buckle for the appropriate seat and push it down until it is securely locked with an audible click. ▶

## Seat belts

- ▶ Pull the belt to check that it is now securely fastened.

The three-point inertia reel belts are tensioned automatically. The retractor system gives complete freedom of movement, as long as the pull on the belt is slow. Hard braking locks the belt. The belt will also lock when you accelerate, drive up or down a steep hill or corner sharply.

### WARNING

- Always make certain that the belt is positioned properly ⇒ *Fig. 220* - risk of injury ⇒ *page 278, Adjusting the seat belts*.
- The latch plate of the belt must always be engaged in the correct buckle for that seat. Otherwise the belt will not be fully effective and the danger of injury increases.

### Adjusting the seat belts

Always position seat belts properly for maximum safety.

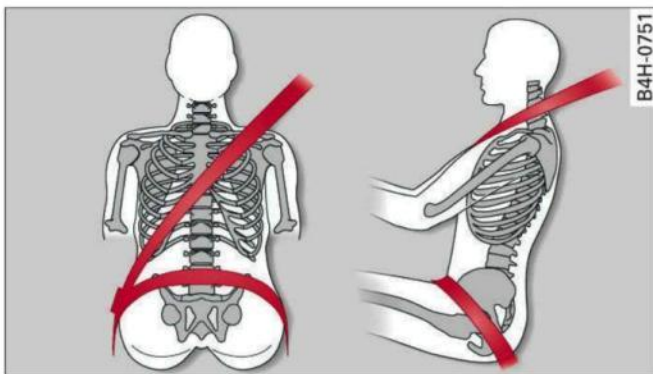

Fig. 222 Adjusting shoulder/lap belt

The following features allow you to match the position of the seat belt to your height:

- Belt height adjustment\*
- Seat height adjustment (front seats)

### WARNING

- The shoulder section of the belt should be fitted across the centre of the collar bone close to the body. To fasten the belt, take hold of the belt above the latch plate and pull it slowly down across your chest. Wear the lap portion of the seat belt as low as possible over the hips so that there is no

pressure on the lower abdomen. The belt should always be worn tightly ⇒ *Fig. 222*. Pull the belt tight if necessary to take up any slack.

- Always make sure that belt is positioned properly. Incorrectly worn seat belts can give rise to injuries even in a minor collision.
- Seat belts worn too loose can result in injuries because they allow excessive forward movement in a crash; the occupant will be brought to a sudden stop by the belt webbing.

### Wearing and adjusting the seat belts during pregnancy

To afford the best protection for the unborn child it is important for the mother to wear the seat belt properly at all times.



Fig. 223 Positioning seat belts during pregnancy

Women should always ensure they adjust the seat belt correctly during pregnancy.

- ▶ Adjust the front seat and head restraint correctly before putting on the seat belt ⇒ *page 58, Front seats*.
- ▶ To fasten the belt, take hold of the latch plate and pull it slowly down across your chest. Wear the lap portion of the seat belt as low as possible over the hips so that there is no pressure on the stomach ⇒ *Fig. 223*, ⇒ .
- ▶ Insert the latch plate into the buckle for the appropriate seat and push it down until it is securely locked with an audible click ⇒ *page 277, Fig. 221*.
- ▶ Pull the belt to check that it is now securely fastened. ▶

**! WARNING**

During pregnancy, women should especially make sure to wear the lap portion of the seat belt as low as possible across the hips so that there is no pressure on the stomach.

**Seat belt height adjustment**

Applies to: vehicles with seat belt height adjustment

Seat belt height adjusters can be used to adjust the height of the shoulder portion of the seat belt.

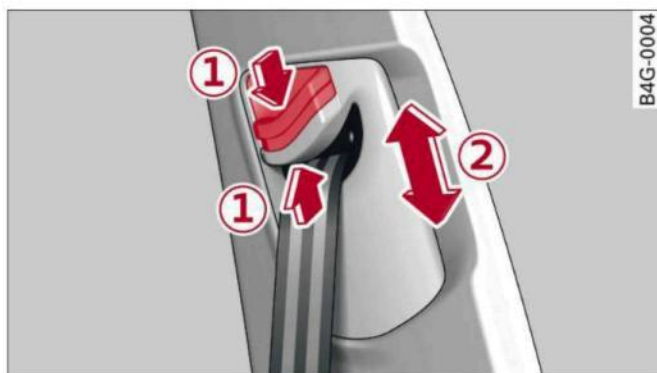

Fig. 224 Belt height adjustment – top guide fitting

The shoulder section of the belt should be fitted across the centre of the collar bone close to the body ⇒ **!** in *Adjusting the seat belts* on page 278.

- ▶ Take hold of the guide fitting and *slide* it **upwards** ②, or
- ▶ *Compress* the adjuster ① and *slide* the guide fitting **downwards** ②.
- ▶ After adjusting, pull the shoulder belt sharply to check that the catch on the guide fitting is engaged securely.

**i Note**

- It is also possible to adjust the height of the front seats to obtain the best position for the front seat belts.
- The shoulder section of the belt should be fitted across the centre of the collar bone close to the body. The lap belt must be worn tightly over the hips. It must not be positioned over the stomach. Pull the belt tight if necessary to take up any slack.

**Taking off the seat belts**

The red button releases the belt from the buckle.



Fig. 225 The latch plate of the belt springs out of the buckle

- ▶ Press the red button in the seat belt buckle. The latch plate will spring out of the buckle.
- ▶ Guide the belt back by hand so that it is taken up by the retractor.

**Belt tensioners****Reversible belt tensioners\***

The following functions are available when seat belts with reversible belt tensioners are buckled:

- The seat belts can be tensioned reversibly in certain situations ⇒ *page 120*.
- The seat belts can be also be tensioned reversibly in light collisions.

**Pyrotechnic belt tensioners\***

Seat belts with pyrotechnic belt tensioners are tensioned automatically in severe collisions, depending on the circumstances. This helps to reduce the forward motion of the occupants.

**! WARNING**

- False activation of the belt tensioner is possible.
- Any work on the tensioner system or removal and installation of system components for other repairs must be performed by a qualified workshop.
- The pyrotechnic system can only be activated once. If the pyrotechnic belt tensioners have been activated at any time, the system must be replaced.

### Note

- Some smoke may be released when the pyrotechnic belt tensioners are activated. This does not mean there is a fire in the vehicle.
- The relevant safety requirements must be observed when the vehicle or components of the system are scrapped. Your authorised dealer is familiar with these regulations and will be pleased to pass on the information to you.

## Airbag system

### Description of airbag system

#### General notes on airbag system

*The airbag is an integral part of the car's passive safety system.*

In conjunction with the three-point seat belts, the airbag system gives the front occupants additional protection for the head and chest in the event of a severe frontal collision.

In a severe side collision the side airbags and the head-protection airbags reduce the risk of injury to the occupants ⇒ .

In addition to their normal function of protecting the occupants in a collision, the seat belts also hold them in a position where the airbags can inflate properly and provide maximum protection.

The airbag system will only work with the ignition on. The airbag system is monitored electronically; the airbag warning lamp indicates whether the system is functioning properly.

#### The main parts of the airbag system are:

- The electronic monitoring system (control unit and sensors)
- The two front airbags
- The front side airbags
- The head-protection airbags
- The indicator lamp  in the instrument cluster

#### There is a fault in the airbag system if the warning lamp

- does not come on when the ignition is switched on.
- does not go out about 4 seconds after the ignition is switched on.
- goes out and then comes on again after the ignition is switched on.
- comes on or flickers while the car is moving.

#### WARNING

- The airbags are not a substitute for the seat belts; they are an integral part of the car's overall passive safety system. The airbags

can only offer effective protection if the occupants are wearing their seat belts. For this reason it is very important to wear the seat belts at all times ⇒ *page 275, Why is it so important to use seat belts?*.

- The seat belts and airbags can only provide maximum protection if the occupants are seated correctly ⇒ *page 58, Front seats*.
- If you do not wear a seat belt, if you lean forward, or are not seated correctly while the vehicle is in motion, you are at greater risk of injury should the airbag system be triggered in an accident.
- Components of the airbag system are located in various parts of the vehicle. If repairs to other vehicle components make it necessary to perform work on the airbag system or to remove or install parts of the airbag system, this may cause damage to the airbag system. As a result, the airbags may not inflate correctly or may not be triggered at all in an accident situation. For this reason, you should always have the work carried out by a qualified workshop.
- If a fault should occur in the airbag system, have the system checked immediately by a qualified workshop. Otherwise the system may fail to trigger in an accident.
- Do not attempt to modify components of the airbag system in any way.
- Never make any alterations to the front bumper or the body.
- Do not remove the front seats.
- The airbag system can only be activated once; if the airbag has been triggered, the system must be replaced. Should the airbag system or airbag modules have to be replaced, the qualified workshop carrying out the replacement will document all details.
- If any repair work is required or the airbag and restraint systems have to be replaced, have the work carried out by your authorised Audi dealer or a qualified workshop which adheres to the Audi factory standards. This will minimise the risk of injury.
- If you sell the vehicle, remember to pass on the complete Service Wallet to the new owner. If any of the airbags have been

deactivated, it is important that the new owner is also given the relevant documents.

- The relevant safety requirements must be observed when the vehicle or components of the airbag or belt tensioner systems are scrapped.

### When are the airbags triggered?

One or more airbag systems are triggered in severe collisions, depending on the circumstances.

### Factors determining the triggering response

It is not possible to define the exact triggering response of the airbag system in all possible situations, since the circumstances in different types of accident will vary considerably. Important factors include, for example, the nature (hard or soft) of the object which the car hits, the angle of impact, vehicle speed and so on.

Whether the airbags are triggered depends primarily on the vehicle deceleration rate resulting from the collision. By processing the signals from the sensors located in the vehicle, the electronic control unit is immediately able to evaluate the severity of the collision and activate the restraint systems accordingly. If the deceleration rate is below the predefined reference value in the control unit the airbags will not be triggered, even though the accident may cause extensive damage to the car. In these situations, the occupants are protected by wearing the seat belts.

#### Note

The airbag may release a fine dust when it inflates. This is quite normal and does not mean there is a fire in the vehicle.

## Front airbags

### Important notes on front passenger's airbag



Fig. 226 Version 1, passenger's sun visor: Airbag sticker



Fig. 227 Version 2, passenger's sun visor: Airbag sticker

A sticker<sup>1)</sup> with important information about the front passenger's airbag is provided on the front passenger's sun visor. Please refer to the safety notes in the following chapters:

- Child seats and front passenger's airbag  
⇒ page 267, *Safety notes for using child seats*
- Safe distance from front passenger's airbag  
⇒ page 284, *Important safety notes on the front airbag system*
- Objects between front passenger and front passenger's airbag  
⇒ page 284, *Important safety notes on the front airbag system*

<sup>1)</sup> Not available in all export vehicles.

### Description of front airbags

The airbag system is not a substitute for the seat belts.



Fig. 228 Steering wheel: Driver's airbag



Fig. 229 Dashboard: Front passenger's airbag

The front airbag for the driver is located in the padded hub of the steering wheel ⇒ Fig. 228. The front airbag for the front passenger is in the dashboard above the glove box ⇒ Fig. 229. The locations of the airbags are marked with the word "AIRBAG".

In conjunction with the three-point seat belts, the front airbags give additional head and chest protection for the driver and front passenger in the event of a severe frontal collision ⇒ **⚠** in *Important safety notes on the front airbag system* on page 284.

### How the front airbags work

When fully inflated, the airbags reduce the risk of head or chest injury.



Fig. 230 Front airbags in inflated condition

The driver's and front passenger's airbag are triggered in certain frontal collisions ⇒ Fig. 230. Further airbag systems may also be triggered, depending on the circumstances.

When the system is triggered, the airbags fill with a propellant gas and open out in front of the driver and front passenger ⇒ Fig. 230. In order to provide the desired extra protection in an accident, the airbags have to inflate extremely rapidly (within fractions of a second). The fully deployed airbags cushion the forwards movement of the front occupants and help to reduce the risk of injury to the head and the upper part of the body.

Special openings in the airbag allow the gas to escape at a controlled rate to restrain the forward movement of the occupant's head and torso. Once the impact has been absorbed, the airbag deflates sufficiently for the front occupants to see forward.

### Important safety notes on the front airbag system

There are a number of safety points concerning the airbag system which you should remember. This will help to reduce the risk of injury in an accident.

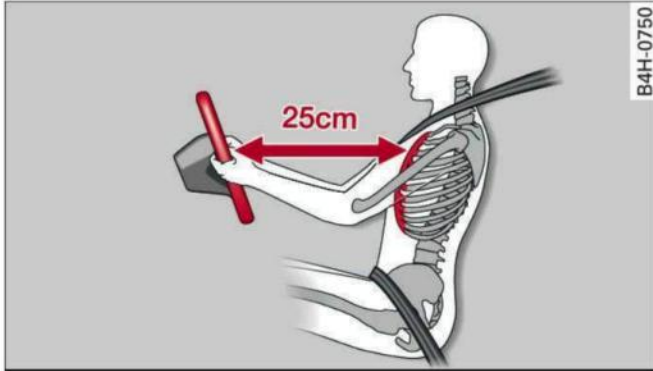

Fig. 231 Minimum distance from steering wheel

### WARNING

- It is important for the driver and front passenger to maintain a distance of at least 25 cm from the steering wheel or dashboard ⇒ Fig. 231. The airbag system will not be able to give the required protection if you sit too close to the steering wheel or dashboard.
- There is also a risk of injury if the airbags are inflated. The front seats and head restraints must always be positioned correctly for the height of the occupant.
- If you do not wear a seat belt, if you lean forward or to the side, or are not seated correctly while the vehicle is in motion, you are at greater risk of injury. Should the airbag system be triggered in an accident there is an even greater risk of injury.
- Never let a child travel on the front seat without an appropriate restraint system. If the airbag is triggered in an accident, the child could sustain serious or fatal injuries ⇒ page 267, *Child seats*.
- Child seats in which the child faces the rear of the car are located directly in the path of the front passenger's airbag if it inflates. In this case, the child could sustain serious or fatal injuries if the airbag were to be deployed.

- Applies to vehicles on which the front passenger's airbag cannot be deactivated: Do NOT use a rearward-facing child seat on the front passenger's seat.
- Applies to vehicles with key-operated switch for deactivating the front passenger's airbag: Do NOT use a rearward-facing child seat on the front passenger's seat while the front passenger's airbag is active. If you have no alternative but to use a rearward-facing child seat on the front passenger's seat, the front passenger's airbag must be deactivated beforehand via the key-operated switch\* ⇒ page 288. Make sure that the front passenger's airbag is reactivated by means of the key-operated switch\* as soon as the child seat is no longer needed on the front passenger's seat.
- Occupants sitting in the front of the car must never carry any objects or pets in the space between them and the airbags, or allow children or other passengers to travel in this position.
- Do not cover or stick anything on the steering wheel hub or the soft plastic surface of the airbag unit on the passenger's side of the dashboard, and do not obstruct or modify them in any way. These parts should only be cleaned with a dry cloth (or with a cloth moistened with plain water). It is also important not to attach any objects such as cup holders or telephone mountings to the surfaces covering the airbag units.
- Any work on the airbag system or removal and installation of the airbag components for other repairs (such as repairs to the steering wheel or removal of seats) must be performed by a qualified workshop.



## Side airbags

### Description of side airbags

The airbag system is not a substitute for the seat belts.



Fig. 232 Side airbags: Location in driver's seat (example)

The side airbags are located in the backrest padding of the front seats.

In conjunction with the three-point seat belts, the side airbags give the occupants additional protection for the whole upper part of the body (i.e. the chest, stomach and pelvis) in the event of a severe side collision ⇒ **⚠** in *Important safety notes on the side airbag system on page 285*.

In a side collision the side airbags reduce the risk of injury to the areas of the body facing the impact.

### How the side airbags work

When fully inflated, the side airbags reduce the risk of injuries to the upper part of the body.



Fig. 233 Side airbags in inflated condition

In certain types of side collision, the side airbag (front) is triggered on the impact side of the vehi-

cle ⇒ Fig. 233. Further airbag systems may also be triggered, depending on the circumstances.

When the system is triggered, the airbag is filled with propellant gas.

In order to provide the desired extra protection in an accident, the airbags have to inflate extremely rapidly (within fractions of a second).

The fully deployed airbags cushion the impact for the occupants and help to reduce the risk of injury to the upper part of the body on the side facing the door.

### Important safety notes on the side airbag system

There are a number of safety points concerning the airbag system which you should remember. This will help to reduce the risk of injury in an accident.

#### **⚠** WARNING

- If you do not wear a seat belt, if you lean forward, or are not seated correctly while the vehicle is in motion, you are at greater risk of injury should the side airbags be triggered in an accident. This applies particularly to children if they are not properly protected by a child restraint system.
- If children are not seated correctly, they are at greater risk of injury should the airbag system be triggered in an accident. This is particularly the case if the child is travelling on the front passenger's seat and the airbag system is triggered in an accident. This could result in serious or potentially fatal injury ⇒ page 267, *Child seats*.
- It is important not to attach any accessories (such as cup holders) to the doors. This would impair the protection offered by the front side airbags.
- The sensors for the airbags are located in the front doors. You must therefore not make any modifications to the doors or door trim (e.g. retrofitting loudspeakers), as this could impair the function of the side airbags. Any damage to the front doors could

lead to faults in the system. Repairs or any other work on the front doors must therefore always be carried out by a qualified workshop.

- The built-in coat hooks\* should only be used for lightweight clothing. Do not leave any heavy or sharp-edged objects in the pockets.
- Do not apply excessive force to the sides of the backrests (such as hard knocks or kicks), as this could damage parts of the system. The side airbags could then fail to operate when required.
- If you intend to fit protective covers over the seats, these must be of the specific type approved for use on Audi seats with side airbags. Conventional seat covers would obstruct the side airbag when it inflates out of the backrest, and seriously reduce the airbag's effectiveness.
- Any damage to the original seat upholstery or around the seams of the side airbag units must be repaired immediately by a qualified workshop.
- Any work involving the side airbag system or removal and installation of the airbag components for other repairs (such as repairs to the seats) must always be performed by a qualified workshop. Otherwise the airbag system may fail to work properly.

### **i** Note

All the other airbags in the car will remain functional if the front passenger's airbag has been deactivated.

## Head-protection airbags

### Description of head-protection airbags



**Fig. 234** Location of head-protection airbags above the doors (example)

The head-protection airbags are located above the doors on the left and right sides of the vehicle. The locations of the airbags are marked with the word "AIRBAG".

In conjunction with the three-point seat belts and side airbags, the head-protection airbags give the occupants additional protection against head and neck injuries in a severe side collision ⇒ **⚠** in *Important safety notes on the head-protection airbags on page 287*.

Together with other design features (including cross-braces in the seats and the overall strength of the body structure), the head-protection and side airbag system offers an effective further improvement to occupant protection in side impacts.

### How the head-protection airbags work

*When fully inflated, the airbags reduce the risk of head or chest injury in a side collision.*



**Fig. 235** Head-protection airbags in inflated condition (example)

The head-protection airbag system is triggered in certain types of side collision ⇒ *Fig. 235*. Further airbag systems may also be triggered, depending on the circumstances.

When the system is triggered, the airbag fills with a propellant gas and covers the entire area in front of the side windows, including the door pillars. The head-protection airbag inflates to soften the impact if an occupant strikes parts of the interior or objects outside the vehicle with their head. By reducing the head impact and restraining uncontrolled movement of the head, the airbag also reduces the forces acting on the neck.

In order to provide the desired extra protection in an accident, the airbags have to inflate extremely rapidly (within fractions of a second).

### Important safety notes on the head-protection airbags

*There are a number of safety points concerning the airbag system which you should remember. This will help to reduce the risk of injury in an accident.*

#### WARNING

- It is important to ensure that the area around the openings for the head-protection airbags remains unobstructed at all times, so that the airbags can inflate properly if needed.
- The built-in coat hooks should only be used for lightweight clothing. Do not leave any heavy or sharp-edged objects in the pockets. When using the coat hooks, do not hang the clothes on coat hangers.
- The space between the passengers and the head-protection airbags must never be occupied by children, other passengers or pets. Passengers should never lean out or put a hand or arm out of the window while the vehicle is in motion.
- Do not move the sun visors out to cover the side windows if there is anything attached to them (such as pens or a garage door

- opener). These objects could cause injury if the head-protection airbag is triggered.
- The sensors for the airbags are located in the front doors. You must therefore not make any modifications to the doors or door trim (e.g. retrofitting loudspeakers), as this could impair the function of the side airbags. Any damage to the front doors could lead to faults in the system. Repairs or any other work on the front doors must therefore always be carried out by a qualified workshop.
- Sun blinds fitted on the rear doors must not obstruct or impair the airbags in any way.
- If unsuitable accessories are installed near the head-protection airbag, the protection afforded by the airbag can be seriously impaired if the system is triggered. When the head-protection airbag opens, parts of these accessories could be thrown into the vehicle and injure passengers ⇒ *page 340*.
- Any work involving the head-protection airbags, or removal and installation of the airbag components for other repairs (such as repairs to the roof liner), must always be performed by a qualified workshop. Otherwise the airbag system may fail to work properly.

### Deactivating the front passenger's airbag

Applies to: vehicles with key-operated switch for front passenger's airbag

*If an airbag has been deactivated, it should be reactivated as soon as possible so that it can continue to give the required protection.*



**Fig. 236** Glove box: Key-operated switch for deactivating front passenger's airbag



**Fig. 237** Headliner: Warning lamp lights up when passenger's airbag is deactivated



If you have no alternative but to install a rearward-facing child seat on the front passenger's seat you must deactivate the front passenger's airbag beforehand.

We recommend that child seats should be fitted on the rear seat so that the front passenger's airbag can remain functional and provide protection in an accident ⇒ *page 267*.

- ▶ To deactivate the front passenger's airbag, use the key to turn the key-operated switch to OFF ⇒ *Fig. 236*.
- ▶ The front passenger's airbag can be reactivated by turning the key to position ON.

### Monitoring of airbag system

The indicator lamp  ⇒ *page 31* will light up for a few seconds every time the ignition is switched on.

If the front passenger's airbag has been deactivated, the indicator lamp "PASSENGER AIR BAG OFF " or " AIR BAG OFF " will light up constantly as a reminder ⇒ *Fig. 237*.

#### **WARNING**

- If you have no alternative but to install a rearward-facing child seat on the front passenger's seat, the front passenger's airbag must be deactivated beforehand. Potentially fatal injuries to the child can result if the front passenger's airbag is not deactivated ⇒ *page 267*!
- If you have deactivated the front passenger's airbag, reactivate it as soon as the child seat is no longer needed so that the airbag can continue to give the required protection.
- It is the driver's responsibility to ensure that the key-operated switch is set to the correct position.

## Checking and topping up fluids

### Fuel

#### Petrol grade

Applies to: vehicles with petrol engine

*The correct grade of petrol is listed inside the fuel tank flap.*

The vehicle is equipped with a catalytic converter and must only be run on **unleaded petrol**. Petrol must be **sulphur-free** and must comply with the EN 228 standard. You can fuel your vehicle with fuels containing a maximum of 10% ethanol (E10). The petrol grades have different **octane ratings** (RON).

The following headings relate to the sticker on the inside of your vehicle's tank flap:

#### Unleaded fuel only RON/ROZ 95 Super, Premium or min. RON/ROZ 91 Normal

The use of premium petrol (95 RON) is recommended. If that type of fuel is not available, regular petrol (RON 91) can be used with a slight loss of power.

#### Unleaded fuel only, min. RON/ROZ 95 Super, Premium

Premium petrol (at least 95 RON) must be used.

If premium petrol is not available, the engine can be run on regular petrol with 91 RON as an *emergency measure*. In this case only use moderate engine speeds and a light throttle. Fill up with premium or Super Plus petrol as soon as possible.

#### Unleaded fuel only RON/ROZ 98 Super Plus or min. RON/ROZ 95 Super, Premium

The use of Super Plus petrol (98 RON) is recommended. If that type of fuel is not available, premium petrol (RON 95) can be used with a slight loss of power.

If premium petrol is not available, the engine can be run on regular petrol with 91 RON as an *emergency measure*. In this case only use moderate engine speeds and a light throttle. Fill up with

premium or Super Plus petrol as soon as possible.



#### CAUTION

- Do **NOT** fuel your vehicle with high-ethanol fuel blends (e.g. E50 or E85). This will damage the fuel system.
- Just one tank of leaded fuel or fuel with metallic additives will permanently impair the efficiency of the catalytic converter.
- You should use only petrol additives which have been approved by Audi. Additives with so-called octane boosters or antiknock additives can contain metallic additives that cause significant damage to the engine and the catalytic converter. Do not use such additives.
- Metal-based fuels, which can be identified from the marking on the fuel dispenser, must not be used. LRP fuel (lead replacement petrol) also contains high concentrations of metallic additive. Risk of engine damage!
- High engine speed and full throttle can damage the engine when using petrol with an octane rating lower than the correct grade for the engine.



#### Note

- You can use higher octane fuel than your engine requires.
- In countries where sulphur-free fuel is not available, you may use low-sulphur fuel instead.

#### Diesel fuel

Applies to: vehicles with diesel engine

*Please note the information on the inside of the fuel tank flap.*

The use of **sulphur-free diesel** complying with the EN 590 standard is recommended.

Diesel can thicken at very low temperatures, which can result in problems starting the engine or prevent the engine from running smoothly. For this reason, filling stations in some countries offer winter-grade diesel fuel during the cold ▶

## Checking and topping up fluids

months so that you can continue to operate your vehicle reliably. Ask at your filling station whether the diesel fuel available there is suitable for the current conditions and for the temperatures which could potentially occur.

### CAUTION

- Never use FAME fuels (biodiesel), petrol, heating oil, thinners or any other fuels or additives, as these could cause serious damage to the fuel system and the engine.
- Never start the engine if you fill up with the wrong type of fuel, as this could damage the fuel system and the engine. Obtain professional assistance.

## Filling the tank

### Procedure for filling the tank



**Fig. 238** Vehicle as seen from the rear right: Opening the fuel tank flap



**Fig. 239** Fuel tank flap with tank cap attached

The fuel tank flap is unlocked and locked automatically by the central locking system.

### Unscrewing the tank cap

- ▶ Press the left side of the flap to open it -arrow- ⇒ *Fig. 238*.
- ▶ Unscrew the tank cap anti-clockwise.

- ▶ Hook the cap onto the open flap ⇒ *Fig. 239*.

### Closing the tank cap

- ▶ Screw on the tank cap clockwise until it clicks audibly.
- ▶ Close the tank flap. Make sure you hear it click into place.

When the automatic filler nozzle is operated correctly it will switch itself off as soon as the tank is full. Do not try to put in more fuel after the nozzle cuts out, as this will fill the expansion chamber in the fuel tank.

The correct fuel grade for your vehicle is given on a sticker on the inside of the tank flap. Further notes on fuel ⇒ *page 289*.

The tank capacity of your vehicle is given in the **Technical data** section ⇒ *page 343*.

### WARNING

Fuel is highly inflammable and can cause serious burns and other injuries.

- For safety reasons we do not recommend carrying a spare fuel canister in the vehicle. The canister could become damaged in an accident and leak.
- Observe all relevant statutory regulations on using, storing and transporting spare fuel canisters.
- When filling your tank or a spare fuel canister with fuel, do not smoke and keep away from naked flames – risk of explosion!
- If, in exceptional circumstances, you have to carry a spare fuel canister, please observe the following warnings:
  - Never fill fuel into the spare fuel canister with the canister placed in or on top of the vehicle. An electrostatic charge could build up during filling, causing the fuel vapour to ignite – risk of explosion! Always place the canister on the ground to fill it.
  - Insert the filler nozzle as far as possible into the spare fuel canister.
  - If the spare fuel canister is made of metal, the filler nozzle must be in contact with the canister during filling. This helps prevent an electrostatic charge building up.

- Make sure you never spill fuel in the vehicle or in the luggage compartment. Fuel vapour is explosive – danger to life!

**! CAUTION**

- If any fuel is spilt onto the vehicle, it should be removed immediately as it could otherwise damage the paintwork.
- Never run the tank completely dry. If there is an irregular fuel supply, misfiring can occur. As a result unburnt fuel can enter the exhaust system and cause damage to the catalytic converter(s).
- Applies to vehicles with diesel engine: When filling the fuel tank after having run it completely dry, the ignition must be switched on for at least 30 seconds before the engine is started. When you then start the engine it may take longer than normal (up to one minute) for the engine to start firing. This is because air needs to be bled from the fuel system while starting.

**🌿 For the sake of the environment**

Do not try to put in more fuel after the automatic filler nozzle has switched off; this may cause the fuel to overflow if it becomes warm.

**i Note**

Applies to: vehicles with diesel engine

Diesel vehicles are equipped with an incorrect fuelling protection system<sup>1)</sup>. This system ensures that the tank can only be fuelled from a diesel filler nozzle.

- If the filler nozzle is old, damaged or too small, it may not be able to open the protection mechanism on the fuel tank. In this case, try turning the filler nozzle before inserting it in the fuel filler neck, use a different filling pump or seek professional assistance.
- The protection mechanism will not open if you try to add fuel from a spare fuel canister. You can get round this simply by adding the diesel fuel slowly.

**i Note**

The tank flap is not locked when you lock the vehicle from the inside.

**Releasing the tank flap manually**

The tank flap can be released manually if the central locking system should fail to operate.

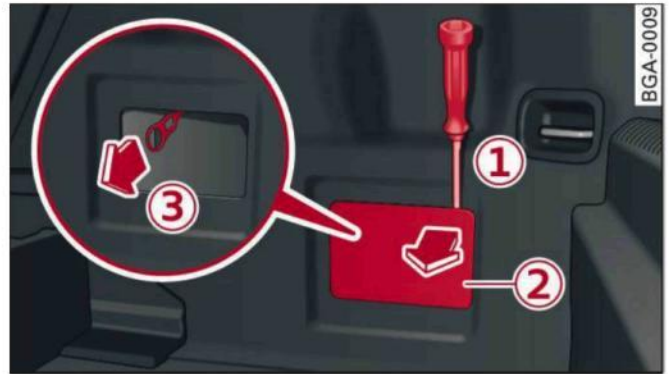

Fig. 240 Luggage compartment (rear right): Manual release under luggage compartment floor

The manual release mechanism is located under the floor panel in the side trim on the right of the luggage compartment.

- ▶ Lift up the floor panel until it is fixed in position behind the retaining tabs on the two side sections ⇒ page 319.
- ▶ Take the screwdriver out of the vehicle tool kit ⇒ page 319. Use the flat-blade side of the reversible insert.
- ▶ Use the screwdriver to prise off the cover ① and remove it ②.
- ▶ Release the ring from its holder and carefully pull the ring ③ -arrow- ⇒ !. The tank flap is then released.
- ▶ Press the left side of the tank flap to open it ⇒ page 290, Fig. 238.

**! CAUTION**

Stop pulling the ring when you feel resistance at the ring/cover (the release mechanism is not audible). Otherwise, you could damage the manual release mechanism.

1) May vary in different countries

# Selective catalytic reduction (AdBlue/DEF)

### General notes

Applies to: vehicles with selective catalytic reduction

On vehicles with selective catalytic reduction, a urea solution (AdBlue/DEF) is injected into the exhaust system upstream of a NOx catalytic converter in order to reduce nitrogen oxide emissions. The urea solution is known under the name of AdBlue or DEF (Diesel Exhaust Fluid). The term AdBlue is used below.

The AdBlue is held in a separate tank on the vehicle. AdBlue consumption is approximately 1.0 - 2.5% of diesel fuel consumption.

As soon as a message appears in the instrument cluster display reminding you to refill AdBlue, you must refill the AdBlue tank or have this done by a qualified workshop ⇒ *page 293*.

### Checking the remaining range

The remaining (estimated) range for the current AdBlue level can be displayed on the on-board computer:

- Vehicles with analogue instrument cluster ⇒ *page 20*.
- Vehicles with virtual cockpit\* ⇒ *page 19*.

### Note

- The instrument cluster display will tell you how far you can drive before the tank runs dry ⇒ *page 292*. If the AdBlue tank runs dry, the engine cannot be started again after you switch off the ignition.
- The use of AdBlue for the operation of this vehicle is required by law.

### Instrument cluster display

Applies to: vehicles with selective catalytic reduction

*The display informs you if the AdBlue level is too low or if a system malfunction occurs.*

### Low AdBlue level

You will be informed if the amount of AdBlue in the tank falls below a certain level. Add at least

the minimum (smaller) amount of AdBlue shown:

 **Refill x l - x l AdBlue. Range: x km**

This message tells you the maximum distance that you can drive with the remaining amount of AdBlue. Refill AdBlue.

 **Refill x l - x l AdBlue! No restart in x km! See owner's manual**

This message tells you the maximum distance that you can drive with the remaining amount of AdBlue. Refill AdBlue. Otherwise, after driving the maximum distance and switching off the engine, you will not be able to restart the car.

 **Refill x l - x l AdBlue! No restart. See owner's manual**

This message appears when there is no more AdBlue left in the tank. Refill AdBlue. Otherwise, you will not be able to restart the car after you switch off the engine.

When the AdBlue in the tank reaches the minimum level, you must add AdBlue ⇒ *page 293, Preparations*.

### Filling the wrong fluid / system fault

If you fill the AdBlue tank with a fluid other than AdBlue and the system detects that the wrong fluid has been added or there is a system fault, a driver message will appear.

 **AdBlue: system fault. No restart in x km! See owner's manual**

This message tells you the maximum distance that you can drive. Drive to a qualified workshop and have the fault rectified. Otherwise, after driving the maximum distance and switching off the engine, you will not be able to restart the car.

 **AdBlue: system fault. No restart! See owner's manual**

This message appears if the system detects that the tank has been filled with the wrong fluid or if there is a system fault. Drive to the nearest qualified workshop without delay and have the fault rectified. Otherwise, you will not be able to restart the car after you switch off the engine.



## Preparations

Applies to: vehicles with selective catalytic reduction



Fig. 241 Vehicle as seen from the rear right: Unscrewing the AdBlue cap

The AdBlue filler neck is located immediately beside the diesel filler neck. Add at least the amount of AdBlue displayed in the instrument cluster. If you do not refill this amount of fluid, the system may not detect that the tank has been refilled and it may not be possible to restart the engine. You can refill with a maximum of 12 litres.

**Important:** A message in the instrument cluster display informs you if you need to refill AdBlue.

- ▶ Park the vehicle on a level surface.
- ▶ Switch off the ignition.
- ▶ Open the tank flap ⇒ *page 290*.
- ▶ Unscrew the cap on the filler neck anti-clockwise ⇒ *Fig. 241*.
- ▶ Refill AdBlue from a filler nozzle ⇒ *page 293*, canister ⇒ *page 294* or bottle ⇒ *page 294*.

### WARNING

AdBlue can cause irritation to the skin, eyes, and respiratory organs. Wash thoroughly with clean water should you come into contact with this fluid. Seek medical assistance if needed.

### CAUTION

- Use only AdBlue that complies with the ISO 22241-1 standard. Do not mix AdBlue with additives and do not dilute it with water.
- AdBlue must not be added to the diesel tank, and diesel must not be added to the AdBlue tank. Never start the engine if you

fill up with the wrong type of fuel, as this could damage the tank system and the engine. Obtain professional assistance.

- AdBlue attacks surfaces such as paintwork, plastic veneer and carpets. Remove spilt fluid as soon as possible with a damp cloth and plenty of water. If the AdBlue has already solidified, use warm water and a sponge. Residues of AdBlue solidify after a while if they are not removed and can damage the affected surface.
- Do not keep refill bottles or canisters in the vehicle, as AdBlue can leak and damage the vehicle interior.
- Keep AdBlue away from clothing. Wash thoroughly with clean water should you come into contact with this fluid.

### Note



Please follow the AdBlue manufacturer's instructions for storage and use.

## Refilling AdBlue from a filler nozzle

Applies to: vehicles with selective catalytic reduction

- ▶ Open the tank flap ⇒ *page 290*.
- ▶ Unscrew the cap on the filler neck anti-clockwise ⇒ *page 293, Fig. 241*.
- ▶ Fill up with AdBlue until the first time the filler nozzle cuts off the supply ⇒ .
- ▶ Put the tank cap back on ⇒ *page 294, After refilling*.

### CAUTION

- The handle of the filler nozzle must point downwards when filling the tank. Otherwise the filler nozzle will not cut off the supply automatically ⇒  in *Preparations on page 293*.
- You should stop refilling the first time the filler nozzle automatically cuts off the supply. Otherwise the level of AdBlue in the tank may be too high and AdBlue could overflow ⇒  in *Preparations on page 293*.

### Refilling AdBlue from a canister

Applies to: vehicles with selective catalytic reduction

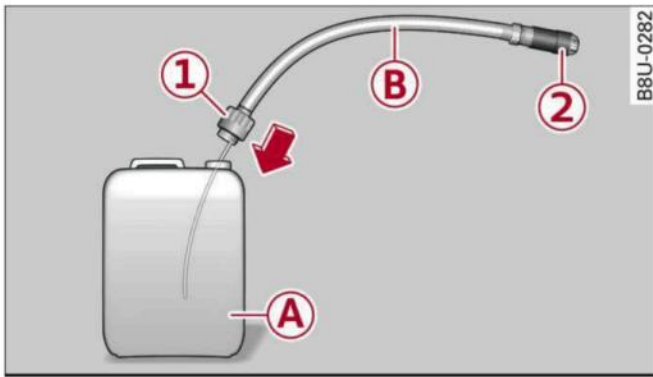

Fig. 242 Canister with screw-on hose

- ▶ Take the cap off the refill canister ⇒ ⚠ in Preparations on page 293, ⇒ ⚠ in Preparations on page 293.
- ▶ Screw the end of the hose ① clockwise onto the opening on the canister ①.
- ▶ Remove the cap ② from the other end of the hose ②.
- ▶ Fit the end of the hose ② onto the filler neck on the vehicle and turn clockwise as far as the stop to secure.
- ▶ Lift the canister and then tilt it. Keep it tilted until empty or until no more fluid runs into the tank.
- ▶ Remove the canister and screw the tank cap back on ⇒ page 294, After refilling.

#### ⚠ CAUTION

Use only refill canisters of the correct type approved for your vehicle. AdBlue may leak out if you use another system.

#### ⓘ Note

- Your qualified workshop can tell you which refill canisters are approved for your vehicle.
- Approved refill canisters contain about 5 litres of AdBlue.

### Refilling AdBlue from a bottle

Applies to: vehicles with selective catalytic reduction

- ▶ Take the cap off the refill bottle ⇒ ⚠ in Preparations on page 293, ⇒ ⚠ in Preparations on page 293.

- ▶ Screw the bottle clockwise onto the filler neck as far as it will go.
- ▶ To empty the bottle, lightly press the bottom of the bottle. Keep pressing the bottom of the bottle until the bottle is empty, or until no more fluid runs into the tank.
- ▶ Remove the bottle and screw the tank cap back on ⇒ page 294, After refilling.

#### ⚠ CAUTION

Use only refill bottles of the correct type approved for your vehicle. AdBlue may leak out if you use another system.

#### ⓘ Note

- Refill bottles are available from qualified workshops.
- Approved refill bottles contain about 1.9 litres of AdBlue.

### After refilling

Applies to: vehicles with selective catalytic reduction

#### Closing the filler neck

- ▶ Screw the AdBlue cap clockwise onto the filler neck until the AdBlue cap clicks audibly ⇒ ⚠ in Preparations on page 293, ⇒ ⚠ in Preparations on page 293.
- ▶ Press the left side of the flap to close it (you should hear it click into place).

#### After refilling

The vehicle must be driven so that the system can detect the AdBlue which has been added. This process can take several minutes.

- ▶ If the AdBlue tank had run dry and a range of 0 km was shown on the display, switch on the ignition for approx. 30 seconds before starting the engine.

#### ⓘ Note

AdBlue can freeze in the tank at very low temperatures. In this case, the system will not detect AdBlue when you refill and will continue to indicate a low AdBlue level. The message will disappear as soon as the tank has thawed.

## Emission control systems

### Catalytic converter

Applies to: vehicles with petrol engine

The vehicle must only be used with unleaded petrol, otherwise the catalytic converter will be irreparably damaged.

Never allow the fuel tank to run completely dry, as the irregular supply of fuel can cause misfiring. This allows unburnt fuel to enter the exhaust system, which can cause overheating and damage to the catalytic converter.

### Diesel particulate filter

Applies to: vehicles with diesel engine

The diesel particulate filter can filter out almost all soot particles contained in the exhaust gas. In normal driving conditions the filter is self-cleaning. Should the self-cleaning function of the filter not be able to operate, e.g. when the vehicle is continuously used only for short trips, the filter becomes obstructed with soot and the indicator lamp  for the diesel particulate filter lights up ⇒ page 34.

#### WARNING

The exhaust system is very hot when the vehicle is being driven and after the engine has been switched off.

- Never touch the tailpipes when they are hot
  - risk of burns!
- Because of the high temperatures which can occur in the emission control system, do not park the vehicle where the exhaust can come into contact with flammable materials under the car (e.g. on grass or at the forest edge) – risk of fire!
- Do not apply any underseal agents in the area around the exhaust system - risk of fire!

## Engine compartment

### Working on components in the engine compartment

*Extra caution is necessary when working on components in the engine compartment.*

**Always be aware of the danger of injury and scalding as well as the risk of accident or fire when working in the engine compartment (e.g. when checking and refilling fluids). Always observe the warnings listed below and follow all normal safety precautions. The engine compartment of any motor vehicle is a potentially hazardous area ⇒ .**

#### WARNING

- Switch off the engine.
- Switch off the ignition.
- Apply the parking brake.
- On vehicles with manual gearbox place the gear lever in neutral, on vehicles with automatic gearbox move the selector lever to position P.
- To avoid the risk of being scalded, never open the bonnet if you see steam or coolant escaping from the engine compartment. Wait until no steam or coolant can be seen before opening the bonnet.
- Wait for the engine to cool down.
- Keep children away from engine compartment.
- Never spill fluids on a hot engine. These fluids can cause a fire (e.g. radiator anti-freeze).
- Take care not to cause short circuits in the electrical system.
- When working in the engine compartment be aware that the radiator fan may start running suddenly, even if the ignition is switched off – risk of injury!
- Do not unscrew the cap on the expansion tank when the engine is hot. The cooling system is under pressure.
- Protect face, hands and arms by covering the cap with a large, thick rag to protect against escaping coolant and steam.

- Never remove the engine cover panel - risk of burns!
- If any tests have to be performed with the engine running, there is an extra safety risk from the rotating parts, such as the drive belts, alternator and radiator fan, etc., and from the high-voltage ignition system.
- Never touch the radiator fan. The electric additional fan is controlled by temperature and can start running without warning.
- Applies to vehicles with automatic gearbox: Never open the throttle inadvertently (for instance by hand from the engine compartment) if a gear is engaged while the vehicle is stationary with the engine running. The vehicle will otherwise start moving immediately and could cause an accident.
- Observe the following additional warnings if work on the fuel system or the electrical system is necessary:
  - Do not smoke.
  - Never work near naked flames.
  - Always keep an approved fire extinguisher immediately available.
- Any work on the batteries and electrical system in your vehicle entails a risk of injury and chemical burns in addition to danger of accident or fire. For this reason, you **must** have the work carried out by a qualified workshop.

### CAUTION

When topping up fluids make sure the correct fluid is put into the correct filler opening. This can otherwise cause serious malfunctions or engine damage.

### For the sake of the environment

Inspect the ground underneath your vehicle regularly so that any leaks are detected at an early stage. If you find spots of oil or other fluids, have your vehicle inspected in the workshop.

### Note

On right-hand drive vehicles\* some of the containers / reservoirs mentioned below are

located on the other side of the engine compartment.

## Opening/closing the bonnet

The bonnet is released from inside the vehicle.



Fig. 243 Detail of footwell on driver's side: Release lever

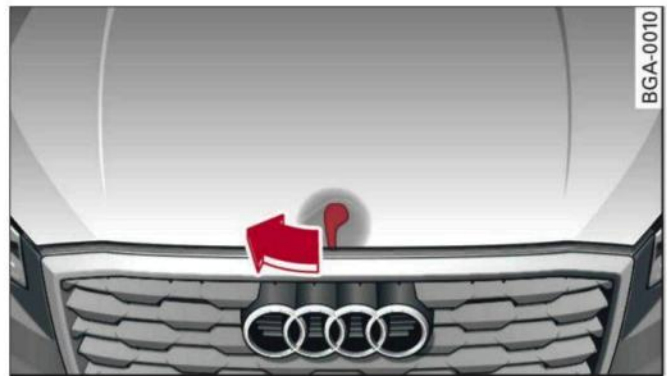



Fig. 244 Unlocked bonnet: Lever

The wiper arms should be resting on the windscreen: make sure they are not in a raised position. Otherwise the paint may get damaged.

### Opening the bonnet

- ▶ With the driver's door open, pull the lever under the dashboard in the direction indicated (arrow) ⇒ Fig. 243.
- ▶ Lift the bonnet slightly ⇒ .
- ▶ Press the lever under the bonnet in the direction indicated by the arrow ⇒ Fig. 244. This will release the arrester hooks.
- ▶ Open the bonnet.

### Closing the bonnet

- ▶ To close the bonnet, pull it down to overcome the spring pressure.
- ▶ Then let it drop into the catches; *do not press down* ⇒ .

**! WARNING**

- To avoid the risk of being scalded, never open the bonnet if you see steam or coolant escaping from the engine compartment. Wait until no steam or coolant can be seen before opening the bonnet.
- For safety reasons the bonnet must always be completely closed when the vehicle is

- moving. After closing it always check that it is properly secured. It should not be possible to lift the front edges of the bonnet.
- Should you notice that the bonnet is not safely secured when the vehicle is moving, stop the vehicle immediately and close the bonnet properly, otherwise it could cause an accident.

**Engine compartment layout**

*Main components for checking and refilling*

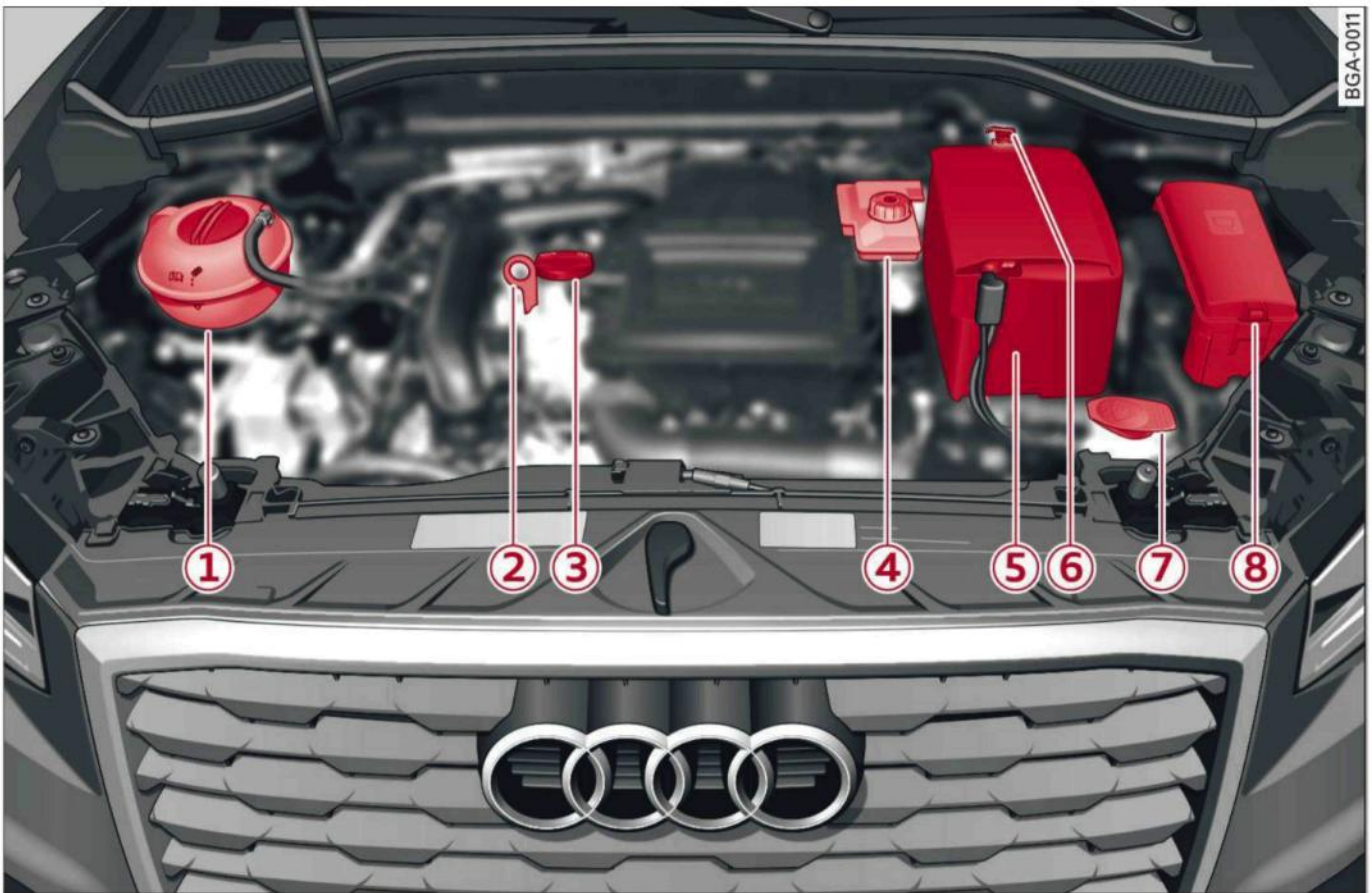

**Fig. 245** Typical locations of fluid containers, engine oil dipstick and engine oil filler cap

- ① Coolant expansion tank (☞) ⇒ page 300
- ② Engine oil dipstick ⇒ page 298
- ③ Engine oil filler cap (☞) ⇒ page 298
- ④ Brake fluid reservoir (☞) ⇒ page 301
- ⑤ Vehicle battery (+) beneath a cover ⇒ page 303, ⇒ page 326
- ⑥ Earth point on body (-) ⇒ page 303, ⇒ page 326
- ⑦ Windscreen washer container (☞) ⇒ page 303
- ⑧ Fuse box ⇒ page 332

The positions of the oil dipstick ② and the engine oil filler cap ③ ⇒ Fig. 245 may be different on some engine versions.

**Engine oil**

**Choosing the correct engine oil grade**

The service interval display in the instrument cluster of your vehicle will inform you when it is time for an oil change. We recommend having the oil changed by a qualified workshop.

## Checking and topping up fluids

If you have to top up the oil between oil changes, use the grades of oil specified in the table in accordance with VW standards.

You will need to know whether

- the vehicle is being serviced based on the flexible or fixed oil change service (see last service record).
- the vehicle has a petrol or diesel engine (see sticker on inside of fuel tank flap).

|                       | Oil Change Service |   |
|-----------------------|--------------------|---|
|                       | Flexible           | Fixed   |
| <b>Petrol engines</b> | VW 504 00          | VW 502 00   |
| <b>Diesel engines</b> | VW 507 00          | With diesel particulate filter:<br>VW 507 00<br><br>Without diesel particulate filter:<br>VW 505 00 |

### Audi recommends

 **EDGE** PROFESSIONAL

**Audi recommends LongLife high-performance engine oil from Audi Genuine Parts**

### Note

If the oil grades specified in the table are not available, you can use one of the following grades as a substitute. To prevent damage to the engine, this should not be done more than once between oil changes and no more than 0.5 litres should be used.

- Petrol engines: ACEA A3 or API SN (API SM) standard
- Diesel engines: ACEA C3 or API CJ-4 standard

### Note

The flexible oil change service is not available for all models in all countries.

## Checking and topping up the engine oil level

The oil dipstick differs depending on the type of engine.

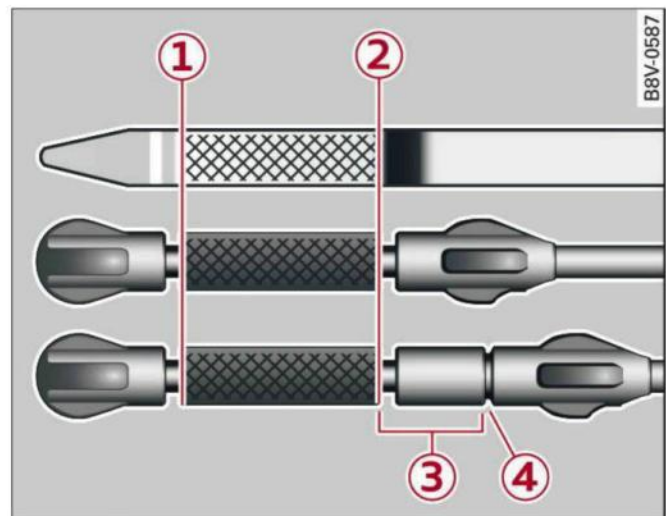

Fig. 246 Oil dipstick (examples): Checking engine oil level



Fig. 247 Engine compartment: Engine oil filler cap (example)



Please refer to the safety notes ⇒ *page 295, Working on components in the engine compartment.*

### Checking engine oil level

- Park the vehicle on a level surface.
- Switch off the warm engine. Wait for a few minutes for the oil to drain back into the sump.
- Open the bonnet ⇒ *page 296.*
- Pull out the oil dipstick ⇒ *page 297, Fig. 245*, wipe it with a clean cloth and insert it again, pushing it in as far as it will go.
- Then pull the dipstick out again and check the oil level ⇒ *table on page 299.*
- If the oil level is too low, add more engine oil. ▶

| Markings on oil dipstick ⇒ Fig. 246 |   |
|-------------------------------------|---|
| ①                                   | When the oil level is near the marking ① you must top up the engine oil. Please refer to ⇒ ⚠.           |
| ②                                   | Do NOT add engine oil.  |
| ③                                   | Do NOT add engine oil. Drive to a qualified workshop without delay and have the engine oil changed ⇒ ⚠. |

### Topping up the engine oil

- Unscrew the cap  ⇒ Fig. 247 from the oil filler opening ⇒ page 297, Fig. 245.
- Carefully add 0.5 litres of suitable engine oil ⇒ page 297.
- After two minutes check the oil level once again.
- If the oil level is too low, add a smaller quantity of engine oil. The level must always be below the marking ② ⇒ Fig. 246 ⇒ ⚠.
- Screw the oil filler cap  back on and push the dipstick all the way in.

### WARNING

- Ensure that no engine oil comes into contact with hot engine components when topping up: this could cause a fire.
- The oil filler cap must be properly closed to prevent oil from squirting onto the hot engine or exhaust system while the engine is running – risk of fire!
- Wash your skin thoroughly if it comes into contact with engine oil.

### CAUTION

- The engine oil must never drop below the marking ① ⇒ Fig. 246 - risk of engine damage!
- When topping up the engine oil, make sure that the oil level is not above the marking ② ⇒ Fig. 246, as this may result in damage to the catalytic converter or to the engine. Do NOT start the engine. Contact a qualified workshop to extract the engine oil if necessary.
- Applies to vehicles which have an oil dipstick with area ③ ⇒ Fig. 246: If you run your

vehicle on diesel fuel of poorer quality than EN 590 standard fuel, the fuel can get into the engine oil. In this case, the oil level gradually rises and the quality of the engine oil decreases. Once the oil level has reached the marking ④ or the indicator lamp  has come on, the engine oil level must not be corrected by extracting the surplus oil - risk of engine damage! The engine oil must be changed ⇒ page 34.

- No additives should be used with engine oil. Any damage caused by the use of such additives would not be covered by the factory warranty.

### For the sake of the environment

- Never pour engine oil down drains or into the ground.
- Always observe statutory requirements when disposing of empty oil canisters.

### Note

Depending on how you drive and the conditions in which the car is used, oil consumption can be up to 0.5 ltr./1000 km. Oil consumption is likely to be higher for the first 5,000 km. The engine oil level must be checked at regular intervals, preferably when refuelling and before setting off on a long trip.

## Cooling system

### Coolant

The engine cooling system is filled at the factory with a mixture of conditioned water and coolant additive. This coolant must not be changed.

The coolant level is monitored by a warning lamp  ⇒ page 30. However, we recommend that it should be checked occasionally.

If you do need to top up the coolant, use a mixture of water and coolant additive. We recommend mixing coolant additive with distilled water.

### Coolant additive

The coolant additive contains anti-freeze and corrosion protection agent. Only use one of the following coolant additives. It is possible to mix these additives.

| Coolant additive | Specification |
|------------------|---------------|
| G13              | TL 774 J      |
| G12++            | TL 774 G      |

The amount of coolant additive which needs to be mixed with the water depends on the temperatures to be expected in the winter season. If the anti-freeze concentration is too low, the coolant can freeze and cause engine damage.

|              | Coolant additive       | Frost protection |
|--------------|------------------------|------------------|
| Hot regions  | min. 40 %<br>max. 45 % | min. -25 °C      |
| Cold regions | min. 50 %<br>max. 55 % | max. -40 °C      |

### ! CAUTION

- Have your qualified workshop check the cooling system before the winter season to make sure that the anti-freeze concentration is adequate for the conditions to be expected. This applies particularly if you drive into a colder climate zone.
- To prevent damage to the engine, do not use a different type of anti-freeze additive if the approved type of additive is not available. In this case use only water and bring the coolant concentration back up to the correct level as soon as possible by putting in the specified additive.
- Always top up with fresh, unused coolant.
- Radiator sealants must not be added to the coolant.

### Topping up coolant



Fig. 248 Engine compartment: Markings on coolant expansion tank

Please refer to the safety notes ⇒ *page 295, Working on components in the engine compartment.*

### Checking coolant level

- ▶ Park the vehicle on a level surface.
- ▶ Switch off the ignition.
- ▶ Read off the coolant level on the coolant expansion tank ⇒ *Fig. 248*. When the engine is cold, the coolant level should be between the marks. When the engine is warm, it may be slightly above the top mark.

### Topping up coolant

Important: The coolant expansion tank must not be empty ⇒ !.

- ▶ Wait for the engine to cool down.
- ▶ Cover the cap on the expansion tank with a cloth, and carefully unscrew the cap anti-clockwise ⇒ ⚠.
- ▶ Add coolant in the correct concentration ⇒ *page 299* up to the top mark.
- ▶ You should make sure that the fluid level remains stable. If necessary, add more coolant.
- ▶ Screw the cap on again tightly.

Any loss of coolant normally indicates a leak in the cooling system. Drive to a qualified workshop without delay and have the cooling system checked. If there are no leaks in the system, a loss of coolant can only occur if the coolant boils and is forced out of the system as a result of overheating. ▶



**! WARNING**

- The cooling system is under pressure. Do not unscrew the cap on the expansion tank when the engine is hot: you could be scalded by escaping steam.
- The coolant and coolant additive can be a health hazard. Store the coolant additive in the original container in a safe place out of reach of children – risk of poisoning.
- When working in the engine compartment be aware that the radiator fan may start running suddenly, even if the ignition is switched off – risk of injury!

**! CAUTION**

- Do not add coolant if the expansion tank is empty. Air could have got into the cooling system - risk of engine damage! In this case, do NOT drive on. Obtain professional assistance.
- Have your qualified workshop check the cooling system before the winter season to make sure that the anti-freeze concentration is adequate for the conditions to be expected. This applies particularly if you drive into a colder climate zone.
  - To prevent damage to the engine, do not use a different type of anti-freeze additive if the approved type of additive is not available. In this case use only water and bring the coolant concentration back up to the correct level as soon as possible by putting in the specified additive.
  - Always top up with fresh, unused coolant.
  - Radiator sealants must not be added to the coolant.

## Brake fluid



Fig. 249 Engine compartment: Cap of brake fluid reservoir

Please refer to the safety notes ⇒ page 295, *Working on components in the engine compartment*.

### Checking brake fluid level

Read off the brake fluid level on the brake fluid reservoir ⇒ page 297, Fig. 245. The brake fluid level must be between the MIN and MAX marks ⇒ **! CAUTION**.

The brake fluid level is also automatically monitored.

In right-hand drive vehicles the brake fluid reservoir is on the other side of the engine compartment.

### Changing brake fluid

Have the brake fluid changed regularly by a qualified workshop.

**! WARNING**

- If the brake fluid level is under the MIN mark, the effectiveness of the brakes and therefore the safety of the vehicle may be impaired - risk of accident! Do not drive on. Obtain professional assistance.
- Heavy use of the brakes may cause a vapour lock if old brake fluid is left in the system. This would seriously impair the effectiveness of the brakes and the safety of the car – risk of accident!

**! CAUTION**

- If the brake fluid level is above the MAX mark, brake fluid may escape via the cap on ▶

the reservoir in certain circumstances and cause damage to the vehicle.

- Brake fluid must not be allowed to come in contact with the vehicle's body, otherwise it will attack the paintwork.





## Battery

### General warnings for batteries

Because of the complexity of the power supply, any battery work, such as disconnection, replacement, etc. **must** be carried out by a qualified workshop ⇒ .

The term "vehicle battery" refers to the 12 Volt battery in your vehicle.

### Explanation of warnings on vehicle battery:

|  |  |
|--|--|
|    | Wear safety glasses!   |
|   | Battery acid is extremely corrosive. Wear protective gloves and safety glasses.        |
|  | Keep open flames, sparks, uncovered lights and lit cigarettes away from the battery!   |
|  | A highly explosive mixture of gases may be given off when the battery is under charge! |
|  | Keep children away from batteries and battery acid.                                    |

### WARNING

Any work on the batteries and electrical system in your vehicle entails a risk of injury and chemical burns in addition to danger of accident or fire. For this reason, you **must** have the work carried out by a qualified workshop.

### CAUTION

If the car is left standing for long periods, protect the battery from frost. The battery will be damaged irreparably if it is allowed to freeze ⇒ *page 303, Charging the vehicle battery.*



### For the sake of the environment

- ♻ Batteries contain toxic substances including sulphuric acid and lead. Please contact a qualified workshop if you have any questions.

### Vehicle battery

The term "vehicle battery" refers to the 12 Volt battery in your vehicle.

### If the vehicle is not used for long periods

If you do not drive your vehicle for a period of several days or weeks, the power management will gradually shut off the on-board systems one by one, or reduce the amount of current they are using. This limits the amount of power consumed and helps to ensure reliable starting even after a long period ⇒ *page 149*. Certain convenience features, such as interior lighting or electric seat adjustment, may not be available. These functions will be restored when you switch on the ignition and start the engine.

Even though some systems are deactivated automatically, certain electrical equipment continues to draw current even when the ignition is off. If the vehicle is left standing for long periods, this can result in total battery discharge. If the vehicle battery is allowed to discharge completely, an internal chemical reaction damages the battery irreparably. To avoid this, the vehicle battery should be recharged at least once a month ⇒ *page 303*. Please contact a qualified workshop if you have any questions.

### Winter conditions

Cold weather is very hard on the vehicle battery. The starting capacity may be reduced as a result. For this reason, you should have the vehicle battery checked by a qualified workshop before the start of winter.

### Charging the vehicle battery

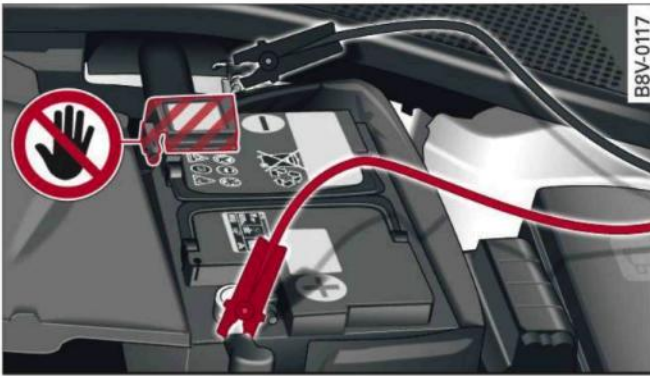

Fig. 250 Engine compartment: Terminals for jump leads and battery charger

Please refer to the safety notes ⇒ page 295, *Working on components in the engine compartment*.

Important: Only use chargers with a **maximum charge voltage of 14.8 V** (the battery cables do not have to be disconnected).

The battery is located in the engine compartment. The earth point ⊖ is always on the vehicle's body.

- ▶ Note the warnings ⇒ ⚠ in *General warnings for batteries on page 302* and ⇒ ⚠.
- ▶ Switch off all electrical equipment and the ignition.
- ▶ Open the bonnet ⇒ page 296.
- ▶ Open the battery cover ⇒ Fig. 250.
- ▶ Connect the charger cables to the **positive terminal (+)** and the **earth point on the body (-)** (not the negative terminal on the battery) as specified.
- ▶ Connect the battery charger to the mains and switch it on.
- ▶ After charging the battery: switch off the battery charger and disconnect the mains cable.
- ▶ Detach the charger cables from the terminals.
- ▶ Fold the cover back onto the battery in its correct position.
- ▶ Close the bonnet ⇒ page 296.

#### ⚠ WARNING

– A highly explosive mixture of gases may be given off when the battery is under charge. Only charge the vehicle battery in a well ventilated area.

- When it is discharged the vehicle battery can freeze at temperatures around 0°C. You must not use a vehicle battery which has frozen, even after it has thawed, because the ice may have cracked the battery casing and allowed the battery acid to escape - risk of explosion and chemical burns! Please contact a qualified workshop if you have any questions.
- Do not connect or disconnect the charging cables during the charging process - risk of explosion!

#### **i** Note

- Use only the terminals in the engine compartment to charge the vehicle battery.
- Before you charge the vehicle battery, always read and follow the manufacturer's instructions for using the battery charger.

## Windscreen washer



Fig. 251 Engine compartment: Cap of windscreen washer container

Please refer to the safety notes ⇒ page 295, *Working on components in the engine compartment*.

The container for the windscreen washer 🚿 contains the cleaning fluid for the windscreen, the rear window\* and the headlight washer system\* ⇒ page 297, Fig. 245. For the container capacity, please refer to ⇒ page 343.

Clean water should be used when topping up. If possible, use soft water to prevent scaling on the washer jets. Always add washer fluid to the water. In cold weather you should add anti-freeze to the water to prevent it from freezing. ▶

### CAUTION

- The anti-freeze concentration must be matched to the climate of the country in which you are driving. If the concentration is too high, damage to the car may result.
- Never put in radiator anti-freeze or other additives.
- Never use washer fluid which contains paint thinners or solvents as it can damage the paintwork.

## Service interval display

*The service interval display detects when the next service is due for your vehicle.*

There are two service interval display levels:

- **Inspection or oil change reminder:** After a certain mileage, a service reminder will appear in the instrument cluster display each time the ignition is switched on/off. The distance or time remaining will be shown briefly.
- **Inspection or oil change due:** When your vehicle is due for an inspection, oil change or both, the corresponding reminder **Inspection due!**, **Oil change due!** or **Oil change and inspection due!** will appear briefly after you switch the ignition on/off.

### Checking the service intervals

On the infotainment system, you can look up the distance and time remaining until the next oil change or next service inspection. Select the following on the infotainment system: **MENU** button > **Car** > left control button > **Servicing & checks** > **Service intervals**.

Applies to: vehicles with flexible oil change service

You cannot check the service interval on a new vehicle until it has been driven for about 500 km.

Qualified workshops reset the service interval after the oil is changed. The distance to the next oil change is initially displayed based on the driving profile prior to the oil change. Your own personal driving profile is used subsequently to calculate the remaining distance. Frequent cold starts or short trips place extra demands on the engine oil

with the result that the oil has to be changed more often.

### Resetting the display

Your qualified workshop resets the service interval display after each service.

It is very important that you reset the oil change display if you change the oil yourself. The next oil change will be due after a fixed service interval.

To reset the display, select the following on the infotainment system: **MENU** button > **Car** > left control button > **Servicing & checks** > **Service intervals** > **Reset oil change interval**.

### CAUTION

- Do not reset the oil change interval display unless you have changed the oil.
- Keeping to the correct service intervals is crucial for the operation, service life and residual value of the vehicle (and especially for the life of the engine). Services must always be carried out promptly, even if the mileage is low.

## Wheels

### Tyres and rims

#### General notes

- ▶ Inspect the tyres regularly for damage (cuts, cracks or blisters, etc.). Remove any foreign bodies embedded in the treads.
- ▶ If you have to drive over a kerb or similar obstacle, drive very slowly and as near as possible at a right angle to the kerb.
- ▶ Damaged rims or tyres must be replaced immediately.
- ▶ Keep grease, oil and fuel off the tyres.
- ▶ Mark the wheels before taking them off so that they rotate in the same direction when refitted.
- ▶ When removed, the wheels should be stored flat in a cool, dry and preferably dark place.



#### CAUTION

- Please note that summer and winter tyres are optimised for the prevailing road conditions at different times of year. We recommend that you use winter tyres during the winter months. At low temperatures, summer tyres lose their elasticity and grip, and braking performance also suffers as a result. Cracks can form in the tread block on summer tyres if they are used at very cold temperatures, and this can cause permanent damage to the tyres. An increase in rolling noise and tyre imbalance may result from this damage.
- Machined, polished or chrome-plated rims must not be used in winter conditions. The process used to manufacture these types of wheel rim does not provide adequate surface protection against corrosion, and the rims can be permanently damaged by road salt or similar.

#### New wheels or tyres

It is best to have all servicing of wheels and tyres performed by a qualified workshop, since they

have the necessary special tools and replacement parts in addition to trained personnel.

- ▶ New tyres do not yet give maximum grip. When driving with new tyres, drive at moderate speeds and be especially careful during the first 500 km.
- ▶ All four wheels must be fitted with tyres of the same type, size (rolling circumference) and preferably the same tread pattern.
- ▶ Tyres should be replaced in pairs and not individually (i.e. both front tyres or both rear tyres together).
- ▶ We recommend the use of Audi Genuine Tyres. If you wish to use other tyres, please note that the actual size can differ from the nominal size marked on the tyre ⇒ .
- ▶ If you wish to purchase a different combination of rims and tyres than the ones fitted on the vehicle during production, it is advisable to consult a qualified workshop beforehand ⇒ .

The sizes of the rims and tyres approved for your vehicle are listed in the vehicle's documents (e.g. EC Certificate of Conformity or COC document <sup>1)</sup>). The vehicle documents vary depending on the country in which the vehicle is registered.

If the spare wheel\* is not the same type as the tyres fitted on the car (for example if the car has winter tyres or wide-section tyres) you should only use the spare wheel\* if a puncture occurs, and then only for a short period of time. In this case, please drive with extra care. Refit a normal road wheel as soon as possible.

Applies to vehicles with four-wheel drive: All four wheels must always be fitted with tyres of the same type, make and tread pattern, as the drive-line could otherwise be damaged by variations in the wheel speeds. For the same reason, only use a spare wheel\* which has the same rolling circumference as the normal road wheels.

#### Manufacturing date

The manufacturing date is indicated on the tyre sidewall (possibly only on the inner side of the wheel):

<sup>1)</sup> COC = Certificate of conformity

### DOT ... 2216 ...

means, for example, that the tyre was produced in the 22nd week of 2016.

### Audi Genuine Tyres

Audi Genuine Tyres with the marking “AO” are specially matched to your Audi. When used properly, these tyres meet the highest standards in safety and handling. Your specialist retailer will be glad to provide more information.

#### **WARNING**

- Use only tyre/rim combinations and matching wheel bolts approved by Audi. Otherwise damage to the vehicle and an accident could result.
- For technical reasons, it is not possible to use wheels from other vehicles. In certain cases, it is not even possible to use wheels from another vehicle of the same model.
- It is very important to ensure that the tyres you have chosen have adequate clearance. When selecting replacement tyres, do not rely entirely on the nominal tyre size marked on the tyre; with some makes of tyre the effective tyre size can differ significantly from the nominal dimensions, even though the tyres have the same size designation. Inadequate tyre clearance can result in damage to the tyres or the vehicle, causing a serious safety risk.
- Avoid running the car on tyres that are more than 6 years old. If you have no alternative, you should drive slowly and with extra care at all times.
- The use of run-flat tyres on your vehicle is NOT authorised! Unauthorised use can cause an accident or damage your vehicle.
- If wheel trims are fitted after the car is purchased, ensure that there is an adequate flow of air for cooling the brakes – risk of accident!

1) Please observe the applicable regulations in the country in which you are travelling.

### Tyre wear / damage



Fig. 252 Tyre tread: Tread wear indicators

### Tyre wear

Inspect the tyres regularly for damage.

- The wear on under or over-inflated tyres is significantly higher.
- Fast cornering, heavy acceleration and hard braking all increase tyre wear.
- If you notice excessive tyre wear, have the wheel alignment checked by a qualified workshop.
- Have your tyres rebalanced if steering wheel vibrations indicate an imbalance. Otherwise, the tyres and other parts of the vehicle may wear faster.

### Tread wear indicators

The original tyres on your vehicle have 1.6 mm high tread wear indicators ⇒ Fig. 252 running across the tread at regular intervals. The letters “TWI” or triangles on the sidewall indicate the positions of the tread wear indicators.

The minimum tread depth<sup>1)</sup> is reached at the latest when the tread is worn down to the tread wear indicators. Replace the tyres with new ones ⇒ .

### Changing wheels round

Wheels should be changed round regularly to ensure that the wear is equal on all tyres. Fit the wheels from the rear axle on the front axle and vice-versa. All the tyres will then last for about the same time. ►

On tyres with a directional tread pattern, note the direction of rotation indicated on the sidewall ⇒ *page 324*.

### Concealed damage

Damage to tyres and rims is often not readily visible. If you notice unusual vibrations or the car pulling to one side, this may indicate that one of the tyres is damaged. Reduce your speed immediately. Inspect the tyres for damage. If no external damage is visible, drive slowly and carefully to the nearest qualified workshop and have the car inspected.

#### WARNING

Insufficient tread depth or different tread depths on different wheels reduce safety. This is particularly evident in vehicle handling, when there is a risk of aquaplaning in deep puddles of water and when driving through corners. Braking is also adversely affected – risk of accident!

### Tyre pressure

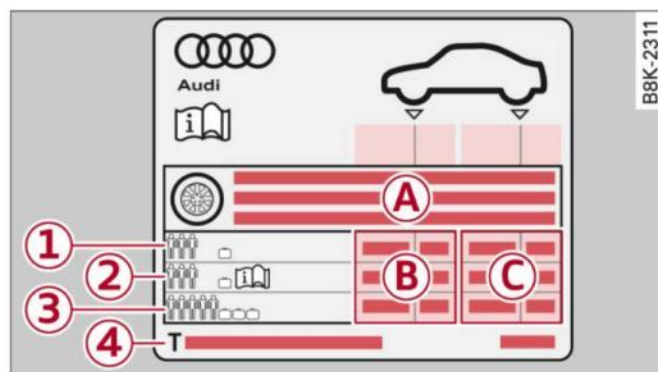

**Fig. 253** End face of driver's door: Sticker listing the tyre pressures

The correct inflation pressures for tyres fitted at the factory and for the compact temporary spare wheel\* are specified on a sticker. The sticker ⇒ *Fig. 253* is on the end face of the driver's door.

- Ⓐ Tyre size
- Ⓑ Tyre pressure for the front wheels
- Ⓒ Tyre pressure for the rear wheels
- ① Tyre pressure if vehicle is partially loaded

② Tyre pressure (comfort setting)\* if vehicle is partially loaded (not available on all vehicles) If a maximum speed is given, it must not be exceeded.

③ Tyre pressure if vehicle is fully loaded

④ Tyre pressure for the compact temporary spare wheel\*

If you intend to drive the vehicle with a partial load (no more than three people travelling in the vehicle), select the specified tyre pressure ①. However, if you prefer an extra-smooth ride you can select the comfort setting\* ②. Should you wish to drive with a full load, you must increase the tyre pressure to the specified maximum ③ ⇒ .

### Checking / adjusting the tyre pressures

- ▶ Check the tyre pressures at least once a month and, in addition, before starting a long journey.
- ▶ The tyre pressures should only be checked when the tyres are *cold*. The slightly raised pressures of warm tyres must not be reduced.
- ▶ Refer to the sticker ⇒ *Fig. 253* for the correct tyre pressures according to the load the vehicle is carrying.
- ▶ If necessary, adjust the tyre pressure.
- ▶ Applies to vehicles with tyre pressure loss indicator : Store the new tyre pressures ⇒ *page 311*.
- ▶ Check the pressure of the spare wheel\*/compact temporary spare wheel\*. Keep the spare tyre inflated to the highest pressure approved for the tyre.

#### WARNING

Always adjust the tyre pressures to match your driving style and the load the vehicle is carrying.

- Excessive loads can cause you to lose control of the vehicle – risk of accident!
- Under-inflated tyres flex more and can over-heat at high speeds or when the vehicle is carrying a heavy load. This could cause a tyre blow-out and you could lose control of the vehicle – risk of accident!

- Incorrect tyre pressures increase tyre wear and adversely affect vehicle braking and handling – risk of accident!

### CAUTION

Replace any lost valve caps to prevent damage to the tyre valves.

### For the sake of the environment

- Under-inflated tyres will increase the fuel consumption.
- Driving with the tyre pressures adjusted to the comfort setting\* may also result in increased fuel consumption.

### Note

We recommend always using the tyre pressure setting ① for partial loads and the setting ③ for full loads.

## Wheel bolts and rims

### Wheel bolts

The wheel bolts should be clean and turn easily. A special adapter is required to turn the anti-theft wheel bolts\* ⇒ page 321.

### Rims

Rims with a bolted rim flange\* or bolted trim parts\* consist of several components. A special technique is applied to bolt these components together. Never attempt to repair or dismantle them ⇒ .

### WARNING

If the wheel bolts have not been tightened or serviced correctly, they can come loose, and you could lose control of the vehicle – risk of accident! For the correct tightening torque, refer to ⇒ page 324, *After changing a wheel*.

- Make sure that the wheel bolts and threads in the wheel hubs are always clean and free from grease.
- Only use wheel bolts that are designed to match the rims on your car.

- Always have damaged rims repaired by a qualified workshop. Never attempt to repair or dismantle rims yourself - risk of accident!

## Winter tyres

In winter road conditions winter tyres will considerably improve the car's handling. Due to their type of construction (width, rubber compound, tread pattern), summer tyres give less grip on ice and snow.

- ▶ Winter tyres must be fitted on all four wheels.
- ▶ Only use winter tyres of the correct type approved for your vehicle.
- ▶ Please note that the maximum permissible speed for winter tyres may be lower than for summer tyres ⇒ . Your specialist retailer can advise you of the maximum speed for your tyres.
- ▶ After fitting the wheels you must always check the tyre pressures ⇒ page 307.

Winter tyres lose their effectiveness when the tread is worn down to a depth of 4 mm. The performance of winter tyres is also severely impaired by ageing, even if the tread is still much deeper than 4 mm.

### WARNING

- Never exceed the maximum approved speed for your tyres. This causes the tyres to overheat and can even result in a blow-out – risk of accident!
- Always adapt your driving style to the prevailing road and traffic conditions. Drive carefully and reduce your speed on icy or slippery roads. Even winter tyres lose their grip on black ice.

### For the sake of the environment

Summer tyres should be fitted again as soon as possible; they give better handling on roads which are free of snow and ice. They are quieter, do not wear so quickly and reduce fuel consumption. ▶



**Note**

All-weather tyres can also be used instead of winter tyres. Please note that winter tyres with the  symbol are required by law during the winter season in some countries.

**Snow chains**

Snow chains will improve braking ability as well as traction in winter conditions.

- ▶ Snow chains can be used on the front wheels only. This also applies to vehicles with four-wheel drive\*.
- ▶ Check that the snow chains are correctly seated after driving for a few yards; follow the instructions given by the manufacturer.
- ▶ Keep your speed below 50 km/h. Please observe the applicable local regulations.

Only use snow chains with **fine-pitch links**. The links must not protrude more than 13.5 mm from the tyres (including tensioner).

You must remove the snow chains on roads which are free of snow; otherwise the vehicle handling may be impaired and the tyres may be damaged.

For technical reasons snow chains may only be used on tyres with certain wheel rim/tyre combinations.

| Rim size        | Rim offset | Tyre size  |
|-----------------|------------|------------|
| 6.0Jx16 (steel) | 43 mm      | 205/60 R16 |

**WARNING**

Unsuitable or incorrectly mounted snow chains can cause you to lose control of the vehicle – risk of accident!

**CAUTION**

Snow chains can damage the rim/hubcap\* if they make direct contact with it. Remove the hubcaps\* beforehand. Use snow chains which have a protective coating.

**Note**

When driving with snow chains, it may help to switch on off-road mode ⇒ *page 146*.

**Low-profile tyres**

Applies to: vehicles with low-profile tyres

Your vehicle is fitted with low-profile tyres\* as standard equipment. Low-profile tyres have a lower sidewall and provide a wider tread surface and rim diameter than other wheel/tyre combinations. This makes the car's handling more agile. However, the ride may be less comfortable on poor-quality roads and tracks, and rolling noise may be louder.

Low-profile tyres can be damaged more quickly than standard tyres, for example by heavy jolts, potholes, manhole covers, speed humps and kerbs. It is therefore particularly important to ensure that they are inflated to the correct pressure ⇒ *page 307*.

Drive with particular care on poor-quality roads to ensure that you do not damage the rims and tyres.

Make sure to check your wheels regularly (every 3,000 km) for damage such as blisters/tears on the tyre sidewalls or deformations/cracks on the rims.

After a heavy jolt, or if any damage occurs, you should have the rims and tyres checked and if necessary replaced by a qualified workshop.

Tyre wear occurs more quickly on low-profile tyres than on standard tyres.

Summer tyres are not suitable for cold conditions, snow or ice. Use winter or all-season tyres when driving in these conditions ⇒ *page 308*.

**Tyre pressure loss indicator****Tyre pressure loss indicator lamp**

Applies to: vehicles with tyre pressure loss indicator

*The tyre pressure loss indicator in the instrument cluster informs the driver if the tyre pressure is too low or a system malfunction has occurred.*

The tyre pressure loss indicator makes use of the ABS sensors to compare the rolling circumference and the vibration of the tyres. If changes in the inflation pressure are detected on one or



more tyres, the driver is alerted by an indicator lamp  and a message in the instrument cluster display. If only one tyre is affected, the display will indicate its position.

Each time you change a tyre, change the wheels round or change the tyre pressures on your vehicle (e.g. when switching from partial load to full load and vice-versa), you must store the new tyre pressures in the menu display ⇒ *page 311*. Monitoring of the tyre pressures is based on the tyre pressures you have stored. The inflation pressures recommended for your vehicle are given on the tyre pressure sticker ⇒ *page 307, Fig. 253*.

The rolling circumference and vibration can change and cause a tyre pressure warning if:

- The inflation pressure in one or more tyres is too low.
- The tyre has suffered structural damage.
- The wheels were changed or the tyre pressures were changed and the new tyre pressures were not stored ⇒ *page 311*.
- The vehicle load is not balanced (more load on one side).
- There is more load on the wheels of one of the axles (e.g. when towing a trailer or driving up or down a gradient).
- You are driving with snow chains.
- You are driving with the temporary spare wheel\*.
- Only one wheel of an axle has been changed.

### Indicator lamps

 - Loss of pressure on one or more tyres ⇒ . Check and change or repair the tyre(s). Check and adjust the tyre pressures again on all four wheels. Then store the tyre pressures in the menu display ⇒ *page 311*.

**TPMS** (Tyre pressure loss indicator) **Tyre pressure: System fault!** If **TPMS** appears and the indicator lamp  in the instrument cluster display flashes for approx. one minute and then remains lit after you have switched on the ignition or while you are driving, there is a fault in the system. Check and adjust the tyre pressures for all four tyres and store the new tyre pressures ⇒ *page 311*. If the indicator lamp does not go out or if it comes

on again after a short time, drive to a qualified workshop without delay and have the fault rectified.

### WARNING

- If the tyre pressure loss indicator appears in the instrument cluster display, slow down immediately and avoid any severe braking or steering manoeuvres. As soon as you can do so safely, stop and check the tyres and the tyre pressures.
- It is the driver's responsibility to ensure that the tyre pressures are correct. For this reason you must check the tyre pressures regularly.
- Under certain conditions (e.g. driving at high speeds, on ice and snow or on poor road surfaces) the tyre pressure loss indicator may not appear immediately.
- The use of run-flat tyres on your vehicle is NOT authorised! Unauthorised use can cause an accident or damage your vehicle.

### Note

- If a malfunction occurs in the ESC/ABS system, the tyre pressure loss indicator may also be out of action.
- When driving with snow chains, a system malfunction can occur.
- The tyre pressure loss indicator on your Audi is specially matched to "Audi Genuine Tyres" ⇒ *page 305*. We recommend that you use these tyres.
- The tyre pressure loss indicator can only monitor the pressures of the tyres fitted on the car. For this reason please regularly check the tyre pressure of the spare wheel in the luggage compartment so it can be used if required.

### Storing tyre pressure settings

Applies to: vehicles with tyre pressure loss indicator

*When you change a tyre or the tyre pressure on your vehicle, you must confirm the change on the system.*

Before storing the new tyre pressures, check that the current pressures on all four wheels correspond to the specified values and adapt the pressures to the current load ⇒ *page 306*.

- ▶ Select the following on the infotainment system: **MENU** button > **Car** > left control button **Servicing & checks** > **Tyre pressure loss indicator** > **Store tyre pressures** > **Yes, store now**.

#### Note

Do not store the tyre pressures if you are driving with snow chains.

## Care of vehicle and cleaning

### General notes

Regular and careful care helps to maintain the value of the vehicle. This may also be one of the requirements for upholding any warranty claims in the event of corrosion or paint defects.

Qualified workshops carry stocks of suitable car care products. Please follow the instructions for use on the packaging.

#### WARNING

- Cleaning products and other materials used for car care can damage health if misused.
- Car care products can contain toxic substances and must always be kept in a safe place out of reach of children.

#### For the sake of the environment

- Please choose care products that are not harmful to the environment.
- Surplus cleaning materials should not be disposed of together with ordinary household waste.

### Washing the vehicle

The longer residues like insects, bird droppings, resinous tree sap or road salt are allowed to remain on the vehicle, the more damage they can do to the paintwork. High temperatures (for instance in direct sunlight) further intensify the damage.

Before washing, soak heavy dirt with plenty of water.

Stubborn dirt, such as bird droppings or resinous tree sap, is best removed with plenty of water and a micro-fibre cloth.

After the period when salt is put on the roads, have the underside of the vehicle washed thoroughly.

### High-pressure cleaners

When cleaning the vehicle with a high-pressure cleaner, always follow the operating instructions for the equipment. This applies particularly to the operating pressure and the spraying distance. Do not point the spray jet directly at the seals on the windows, doors, boot lid, bonnet or panorama sun roof\*, or at the tyres, rubber hoses, insulating material, sensors\* or camera lenses\*. Maintain a distance of at least 40 cm.

Do not use a high-pressure cleaner to remove snow and ice.

Never use high-pressure cleaners with a round-jet nozzle or "dirt blasters".

The water must not be hotter than 60 °C.

### Automatic car washes

Spray the vehicle with water before washing.

Ensure that the windows and panorama sun roof\* are closed and that the windscreen wipers are switched off. Follow the car wash operator's rules and recommendations, especially if any accessories are attached to your vehicle.

If possible use a brushless car wash.

### Washing by hand

Clean the car with a soft sponge or brush, starting on the roof and working down. Use solvent-free cleaning agents.

### Washing matt-painted vehicles by hand

To avoid damaging the paintwork when washing the car, first remove any dust, sand and grit. Insects, grease stains and fingerprints are best removed using a special cleaning agent for matt-painted surfaces.

Apply the product with a micro-fibre cloth. Do not apply too much pressure to avoid damaging the paintwork.

Rinse the car thoroughly with water. Then clean the car with a neutral shampoo and a soft micro-fibre cloth.

Rinse the car with lots of water again and then let it dry in the air. Remove any water stains with a chamois. ►

**! WARNING**

- Follow the rules and recommendations of the car wash operator and do not wash the vehicle with the ignition switched on – risk of accident!
- To avoid cutting yourself on sharp metal parts, always wear suitable protection when cleaning the underside of the car or inside the wheel arches.
- After the car has been washed, the full braking effect can be delayed by moisture (or in winter by ice) on the discs and brake pads – risk of accident! The brakes should be dried by pressing the pedal to restore full braking effect.

**! CAUTION**

- Before washing the vehicle in an automatic car wash, please make sure to retract the exterior mirrors to prevent damage. Always use the electrical power control to fold the mirrors in/out on vehicles with electrically retractable exterior mirrors\*.

- Do not wash the vehicle in direct sunlight – otherwise the paint can be damaged.
- Do not use insect sponges or abrasive household sponges, etc. – they can damage the surfaces.
- Matt-painted vehicle parts:
  - Do not use polish or wax – otherwise the paintwork can be damaged.
  - Never use car-wash programmes that include wax coatings. This could spoil the matt finish.
  - Do not attach any stickers or magnet labels to matt-painted parts as these could damage the paintwork when they are removed.



**For the sake of the environment**

The car should only be washed in special wash bays. This prevents oily water from getting into the public drains.

## Notes on cleaning and care

For cleaning and care of individual components on the vehicle, please refer to the tables below. These are recommendations only. If you have

special questions or certain components are not listed, please ask your qualified workshop. Please also refer to the notes ⇨ .

### Cleaning the exterior

| Component(s)                          | Situation     | Remedy   |
|---------------------------------------|---------------|--|
| <b>Wiper blades</b>                   | Dirt/deposits | ⇨ <i>page 56, Cleaning the wiper blades</i>  |
| <b>Headlights/<br/>rear lights</b>    | Dirt/deposits | Soft sponge with mild detergent <sup>a)</sup>  |
| <b>Sensors/<br/>camera lenses</b>     | Dirt/deposits | Sensors: soft cloth with solvent-free cleaning agent<br>Camera lenses: soft cloth with alcohol-free cleaning agent |
|                                       | Snow/ice      | Small brush/solvent-free de-icer spray   |
| <b>Wheels</b>                         | Road salt     | Water  |
|                                       | Brake dust    | Acid-free cleaning agent   |
| <b>Tailpipes</b>                      | Road salt     | Water; suitable stainless steel cleaning product if necessary  |
| <b>Ornamental trim/<br/>mouldings</b> | Dirt/deposits | Mild detergent <sup>a)</sup> ; suitable stainless steel cleaning product if necessary                              |

| Component(s)        | Situation  | Remedy   |
|---------------------|--|--|
| <b>Paintwork</b>    | Paint damage   | Refer to the vehicle data sticker for the paint no. and touch up using a paint pen ⇒ <i>page 342</i> |
|                     | Fuel overflow  | Rinse with water without delay   |
|                     | Surface rust   | Surface rust remover, apply wax afterwards; contact your qualified workshop with any questions       |
|                     | Corrosion  | Have it removed by your qualified workshop   |
|                     | Water no longer pearls off clean paintwork                           | Apply wax (at least twice a year)  |
|                     | Paint has lost its shine, gloss cannot be restored by waxing         | Treat with a suitable polish; finish with wax coating if polish does not contain wax compounds       |
|                     | Residues, e.g. insects, bird droppings, resinous tree sap, road salt | Remove immediately using water and a micro-fibre cloth   |
|                     | Fat-based stains, e.g. cosmetics or sun lotion                       | Remove immediately using mild detergent <sup>a)</sup> and a soft cloth                               |
| <b>Carbon parts</b> | Dirt/deposits  | Same treatment as painted parts ⇒ <i>page 312</i>  |
| <b>Decals</b>       | Dirt/deposits  | Soft sponge with mild detergent <sup>a)</sup>  |

a) Mild detergent: not more than two tablespoons of pH-neutral detergent to one litre of water

### Cleaning the interior

| Component(s)                       | Situation             | Remedy  |
|------------------------------------|-----------------------|---|
| <b>Windows</b>                     | Dirt/deposits         | Glass cleaning agent, then wipe dry   |
| <b>Ornamental trim/mouldings</b>   | Dirt/deposits         | Mild detergent <sup>a)</sup>  |
| <b>Plastic parts</b>               | Dirt/deposits         | Damp cloth  |
|                                    | Heavier dirt/deposits | Mild detergent <sup>a)</sup> ; solvent-free plastic cleaning agent if necessary |
| <b>Displays/instrument cluster</b> | Dirt/deposits         | Soft cloth with LCD cleaner   |
| <b>Controls and displays</b>       | Dirt/deposits         | Soft brush, then soft sponge with mild detergent <sup>a)</sup>                  |
| <b>Seat belts</b>                  | Dirt/deposits         | Mild detergent <sup>a)</sup> (allow to dry before retracting) ▶                 |

| Component(s)                           | Situation   | Remedy   |
|--|---|--|
| <b>Fabrics, leatherette, Alcantara</b> | Surface dirt  | Vacuum cleaner   |
|  | Water-based stains, e.g. coffee, tea, blood, etc.   | Absorbent cloth and mild detergent <sup>a)</sup>   |
|  | Fat-based stains, e.g. oil, make-up, etc.   | Apply mild detergent <sup>a)</sup> , dab off dissolved grease or colour particles with absorbent cloth; if necessary treat with water    |
|  | Special dirt/stains, e.g. ballpoint pen, nail varnish, dispersion paint, shoe cream, etc. | Special stain remover (dab off with absorbent fabric); if necessary treat with mild detergent <sup>a)</sup>                              |
| <b>Natural leather</b>                 | Fresh dirt/stains   | Cotton cloth with mild detergent <sup>a)</sup>   |
|  | Water-based stains, e.g. coffee, tea, blood, etc.   | Fresh stains: absorbent cloth<br>Dried stains: stain remover suitable for leather  |
|  | Fat-based stains, e.g. oil, make-up, etc.   | Fresh stains: absorbent cloth and suitable stain remover for leather<br>Dried stains: grease removal spray                               |
|  | Special dirt/stains, e.g. ballpoint pen, nail varnish, dispersion paint, shoe cream, etc. | Stain remover suitable for leather   |
|  | Care of vehicle   | Regularly apply leather-care cream with ultra-violet protection and impregnating compound; if necessary use special colour leather cream |
| <b>Carbon parts</b>                    | Dirt/deposits   | Same treatment as plastic parts  |

<sup>a)</sup> Mild detergent: not more than two tablespoons of pH-neutral detergent to one litre of water

 **WARNING**

Do not use water-repellent coatings on the windscreen. In bad visibility conditions such as light rain, low sun or when driving at night these coatings can cause increased dazzle, which is a serious safety hazard. Such coatings can also cause the wiper blades to judder.

 **CAUTION**

- **Headlights/rear lights**
- Never clean the headlights/rear lights with a dry cloth or sponge.

- Do not use cleaning agents containing alcohol. This could cause the glass to crack!
- **Wheels**
- Do not use paint polish or other abrasive agents.
- If the protective paint coating on the wheel rim is scratched or damaged by stone chips etc., the damaged area should be touched up without delay.
- **Sensors/camera lenses**
- Never remove snow and ice from the camera lens using warm or hot water - danger of cracks appearing on the lens.

- Never clean the camera lens with cleaning agents which are abrasive or contain alcohol – danger of scratches and cracks appearing.
- **Windows and windscreen**
  - Remove snow and ice from windows and exterior mirrors with a plastic scraper only. To avoid scratches, the scraper should only be pushed in one direction and not moved to and fro.
  - Never use warm or hot water to remove snow and ice from windows and mirrors. This could cause the glass to crack!
  - To avoid damaging the heating element, do not put stickers on the inner side of the rear window.
- **Ornamental trim/mouldings**
  - Do not use chrome cleaning agents.
- **Paintwork**
  - The vehicle must be free of dirt and dust before applying polish/wax – otherwise the paintwork may be damaged.
  - Do not polish/wax the vehicle in direct sunlight – this can damage the paint!
  - Do not attempt to polish out surface rust deposits – this can damage the paint!
  - Remove cosmetics and sun lotion immediately – otherwise the paintwork may be damaged.
- **Displays/instrument cluster**
  - The displays/instrument cluster and the surrounding trim must not be cleaned with a dry cloth – this can scratch the surfaces!
  - Before cleaning, ensure that the instrument cluster is switched off and cool.
  - Do not let any liquid get between the instrument cluster and the trim – risk of damage!
  - Do not exert heavy pressure on the head-up display\* when cleaning it. This could push the display out of its guide rails - risk of damage!
- **Control consoles**
  - Do not let any liquid get inside the control consoles – risk of damage!
- **Seat belts**

- Do not remove the seat belts to clean them.
- Do not use chemical cleaning agents, corrosive liquids, solvents or sharp instruments to clean the seat belts or their components – this can damage the belt webbing!
- If you find any damage to the belt webbing, the belt fittings, the belt retractor or the buckle, have the belt in question replaced by a qualified workshop.
- **Fabrics/leatherette/Alcantara**
  - Do not use leather care products, solvents, wax polish, shoe cream, stain removers, or any similar products on leatherette/Alcantara fabrics.
  - To avoid damage, stubborn stains should be removed by a qualified workshop.
  - Never use steam cleaners, brushes, hard sponges or similar utensils.
  - Do not use the seat heating\* to dry the seats.
  - Sharp-edged objects on clothing, such as zip fasteners, rivets or belts, can also damage the surface of the fabric.
  - Please make sure you close any velcro fasteners, e.g. on your clothing, as these could otherwise damage the upholstery.
- **Natural leather**
  - Do not use solvents, wax polish, shoe cream, stain removers, or any similar products on leather fabrics.
  - Sharp-edged objects on clothing, such as zip fasteners, rivets or belts, can also damage the surface of the fabric.
  - Never use steam cleaners, brushes, hard sponges or similar utensils.
  - Do not use the seat heating\* to dry the seats.
  - Avoid exposing leather to direct sunlight for long periods, otherwise it may tend to lose some of its colour. If the car is left for a prolonged period in the bright sun, it is best to cover the leather.



**i Note**

- It is much easier to remove dead insects if the car has been waxed recently.
- Regular waxing can help protect against surface rust.

## Taking the vehicle out of service

If you wish to take your vehicle out of service for a long period of time, contact a qualified workshop. Here you will receive advice on necessary measures, for example regarding corrosion protection, servicing and storage. In addition, please observe the general notes on the vehicle battery ⇒ *page 302*.

## Mobility

### General notes

- ▶ If your vehicle experiences technical problems, stop the car well away from moving traffic. If you have a flat tyre, you should park the car on a level surface. Be particularly careful if you are on a slope.
- ▶ Apply the parking brake.
- ▶ Switch the hazard warning lights on.
- ▶ Put on a high-visibility vest if one is available.
- ▶ Place the warning triangle in a visible location ⇒ *page 318*.
- ▶ Instruct all passengers to leave the car when it is safe to do so. They should wait in a safe place (for instance behind the roadside crash barrier).

**! WARNING**

You should note the procedure described above for your own safety and that of other road users.

## Equipment

### Warning triangle

Applies to: vehicles with warning triangle

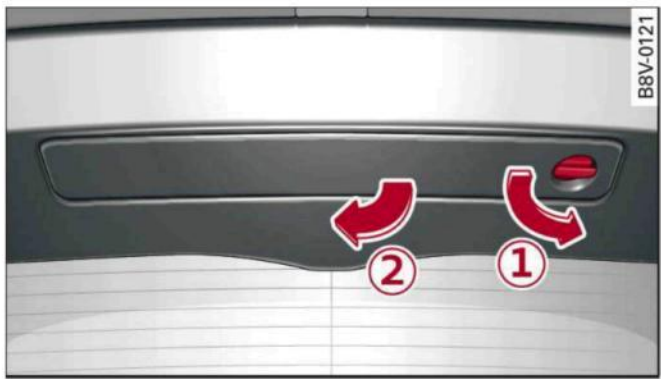

Fig. 254 Open boot lid: Warning triangle

The factory-supplied warning triangle is attached to the inside of the boot lid.

- ▶ To open the cover, turn the catch ① and swivel the cover downwards ②.
- ▶ Pull the warning triangle out of the retainer.

The retainer on the boot lid is specifically designed to hold the warning triangle supplied as an Audi Genuine Accessory.

### First-aid kit

Applies to: vehicles with first-aid kit



Fig. 255 Right rear door: Stowing the first-aid kit (example)

Make sure that you know where the first-aid kit is stowed before beginning your journey.

### Fire extinguisher

Applies to: vehicles with fire extinguisher

The factory-fitted fire extinguisher is located in the footwell on the driver's or front passenger's side (secured in a holder).

- ▶ Open the straps to remove the fire extinguisher.
- ▶ To secure the fire extinguisher, put it in the holder and fasten the straps.

Check how the fire extinguisher works before you need to use it. The instructions for use are shown on the fire extinguisher.

### ! WARNING

If the fire extinguisher is not secured properly it could be catapulted through the vehicle during driving and braking manoeuvres or in the event of an accident. This poses a risk of injury to occupants.

### i Note

- The fire extinguisher must be replaced with a new one after use or once it has reached its expiry date.
- The fire extinguisher must comply with legal requirements.

### Tool kit/tyre repair kit/compressor

Applies to: vehicles with tool kit/tyre repair kit/compressor



Fig. 256 Luggage compartment (example): Floor panel folded up

The tools, tyre repair kit\* and compressor\* are stored under the floor in the luggage compartment.

- ▶ Lift up the floor panel until it is fixed in position behind the retaining tabs ① on the two side sections.
- ▶ Replace the floor panel before closing the boot lid.

#### **i** Note

The jack\* in your vehicle is maintenance-free.

## Tyre repair kit

### Preparations

Applies to: vehicles with tyre repair kit

- ▶ Please refer to the important safety notes on ⇒ *page 318*.
- ▶ Apply the parking brake.
- ▶ Manual gearbox: Engage first gear.
- ▶ Automatic gearbox: Move the selector lever to position P.
- ▶ Check whether a repair is possible using the tyre repair kit ⇒ *page 319*.

### Using the tyre repair kit

Applies to: vehicles with tyre repair kit



Fig. 257 Tyres: Irreparable tyre damage

Repaired tyres are only suitable for temporary use. Replace the damaged tyre as quickly as possible ⇒ ⚠.

If the tyre was damaged by an object, such as a nail, do not remove it from the tyre.

The tyre repair kit can be used at outside temperatures down to - 20 °C.

#### The tyre repair kit must NOT be used:

- On cuts and punctures larger than 4 mm ① ⇒ *Fig. 257*.
- If the wheel rim has been damaged ②.
- If you have been driving with very low pressure or a completely flat tyre ③.

In these cases, you should seek professional assistance.

#### **⚠** WARNING

- Please note that the tyre repair kit is not suitable for use in every situation and should only be used as a temporary measure.
- Do not allow the sealant to come into contact with your eyes, skin or clothing.
- If you do come into contact with the sealant immediately rinse the eyes or skin affected with clean water.
- Make sure you do not breathe in the fumes.
- If you accidentally swallow tyre sealant, immediately rinse your mouth thoroughly and drink a large amount of water. Do not induce vomiting. Immediately contact a doctor.

- Change clothing immediately if it becomes soiled with the tyre sealant.
- If any allergic reactions should occur get medical help immediately.
- Keep the sealant away from children.

### **i** Note

- If sealant should leak out, leave it to dry. When it has dried, you can pull it off like a piece of foil.
- Observe the expiry date stated on the sealing compound can. Have the sealing compound exchanged by a qualified workshop.
- Interference to the radio reception may occur when using the compressor\*.
- Please observe the relevant regulations.

## Tyre repairs

Applies to: vehicles with tyre repair kit



Fig. 258 Tyres: Filling the tyre

Important: The tyre repair kit must be at hand and ready for use ⇒ *page 319*.

### Filling the tyre

- ▶ Shake the tyre sealant can well.
- ▶ Screw the enclosed filling hose onto the sealant can as far as it will go. This will automatically pierce the foil sealing the can.
- ▶ Take the valve cap off the tyre valve and use the enclosed valve insert tool to unscrew the valve insert ⇒ *Fig. 258*.
- ▶ Place the valve insert onto a clean surface.
- ▶ Remove the sealing plug from the filling hose and insert the hose into the tyre valve.
- ▶ Hold the tyre sealant can upside down and fill the complete contents into the tyre.

- ▶ Then disconnect the filling hose and screw the valve insert firmly back into the tyre valve.

### Inflating the tyre

- ▶ Screw the compressor hose (from the tyre repair kit) onto the tyre valve and plug the connector into an electrical socket in the vehicle.
- ▶ Pump the tyre up to 2.0 to 2.5 bar and monitor the pressure shown on the pressure gauge.
- ▶ If the tyre pressure remains lower than the value specified above, remove the hose and drive 10 metres forwards or backwards at a low speed so that the sealant can spread evenly in the tyre. Now pump the tyre up again ⇒ .

### WARNING

- Please observe the manufacturers' safety notes on the compressor and the instructions supplied with the tyre sealant can.
- If it was not possible to build up a tyre pressure of 2.0 bar within six minutes this means that the tyre is too badly damaged. Do not drive on.
- Seek professional assistance if the repair of a tyre puncture is not possible with the sealing compound.

### **i** Note

Do not use the compressor for longer than 6 minutes at a time, as it could overheat. When the compressor has cooled down, you can use it again.

## After repairing a tyre

Applies to: vehicles with tyre repair kit

- ▶ Affix the sticker “max. 80 km/h”, which is included in the tyre repair kit, to the dashboard where the driver will see it.
- ▶ After about 10 minutes, stop to check the tyre pressure.
- ▶ If tyre pressure is less than 1.3 bar, the tyre is too badly damaged. Do not drive on.

### WARNING

After repairing a tyre please note the following points: ▶

- Do not drive faster than 80 km/h.
- Avoid heavy acceleration, hard braking and fast cornering.
- Vehicle handling could be impaired.
- If the tyre is too badly damaged, you should seek professional assistance.

 **For the sake of the environment**  
A used can of sealing compound can be returned to your qualified workshop for disposal.

 **Note**  
After repairing a tyre, remember to buy a new tyre sealant can at a qualified workshop.

## Changing a wheel

### Preparations

*Certain preparations must be made before you change the wheel.*

- ▶ Please refer to the important safety notes on ⇒ *page 318*.
- ▶ Apply the parking brake.
- ▶ Manual gearbox: Engage first gear.
- ▶ Automatic gearbox: Move the selector lever to position P.
- ▶ If you are towing a trailer, unhitch it from your vehicle.
- ▶ Take out the tools ⇒ *page 319* and spare wheel\* ⇒ *page 324*.

 **WARNING**  
If you have to use the jack\* on a gradient or off-road track, block the wheel diagonally opposite the wheel being changed by placing suitable objects underneath both the front and rear of the wheel to prevent the vehicle from rolling away.

### Removing the hubcap/wheel bolt caps

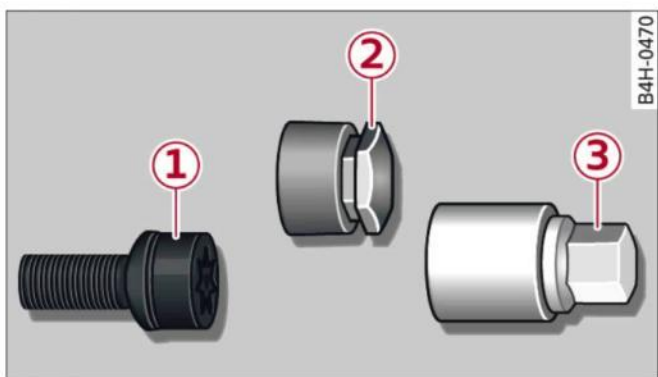

**Fig. 259** Wheel: Wheel bolts with caps

- Applies to: vehicles with wheel bolt caps
- ▶ Slide the plastic clip (provided in the vehicle's tool kit) onto the wheel bolt cap until it engages ⇒ *Fig. 259*.
  - ▶ Pull off the cap using the plastic clip.

- Applies to: vehicles with wheel covers
- ▶ Pull off the wheel cover by hand.

### Anti-theft wheel bolts



**Fig. 260** Anti-theft wheel bolt with wheel bolt cap and adapter

To release the anti-theft wheel bolts, you need a special adapter (provided in the vehicle's tool kit).

- ▶ Pull off the hubcap\* or wheel bolt cap\* ② ⇒ *Fig. 260*.
- ▶ Slide the adapter ③ all the way onto the anti-theft wheel bolt ①.
- ▶ Fit the box spanner (provided in the vehicle's tool kit) as far as it will go over the adapter ③.
- ▶ Loosen the wheel bolt ⇒ *page 322*.

**i Note**

Note the code number of the anti-theft wheel bolt and keep it in a safe place – not in your vehicle. If you need a replacement adapter, give the code number to your Audi dealer.

**Loosening the wheel bolts**



Fig. 261 Wheel: Loosening the wheel bolts

- ▶ Fit the box spanner (provided in the vehicle's tool kit) as far as it will go over the wheel bolt<sup>1)</sup>.
- ▶ Turn the wheel bolt approx. one turn anti-clockwise -arrow-. To apply the necessary torque, hold the box spanner near the end. If the wheel bolt is very tight, you may be able to loosen it by pushing down the end of the spanner carefully with your foot. Hold on to the car for support and take care not to slip.

**! WARNING**

To avoid accidents, the wheel bolts should only be loosened slightly (one turn) before raising the vehicle with the jack\*.

**Raising the vehicle**

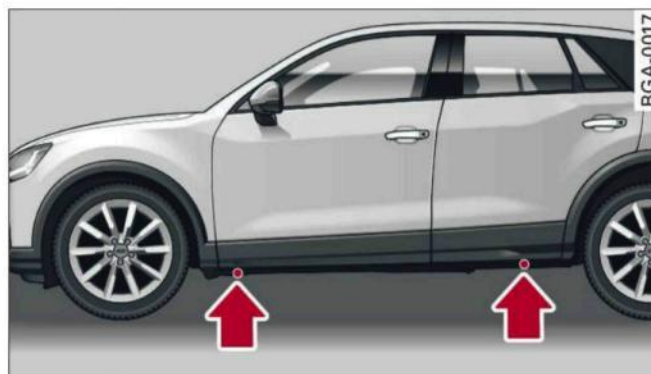

Fig. 262 Sills: markings (example)

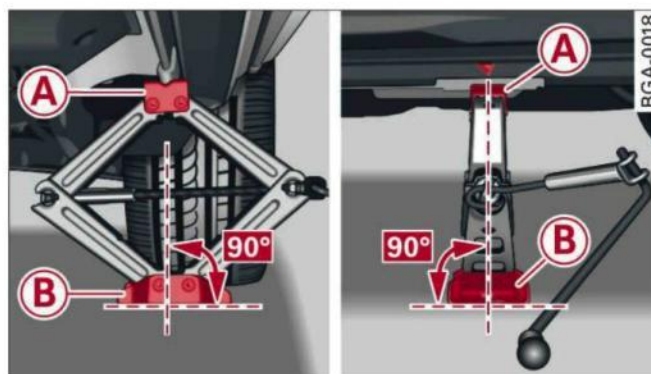

Fig. 263 Door sill: Applying the jack under the door sill

- ▶ Always provide a firm base for the jack\* on the ground. (The jack can be found in the vehicle's tool kit). If necessary use a large, strong board or similar support. On a hard, slippery surface (such as tiles) use a rubber mat or similar to prevent the jack from slipping ⇒ **!.**
- ▶ Locate the marking (recess or rib) on the door sill closest to the wheel being changed ⇒ Fig. 262. The jacking point is located behind the marking under the door sill.
- ▶ Wind up the jack\* under the jacking point until the claw **(A)** ⇒ Fig. 263 of the jack is directly below the jacking point.
- ▶ Align the jack\* so that the claw **(A)** grips the jacking point under the door sill and the movable base plate of the jack **(B)** is flat on the ground. The base plate **(B)** must be positioned vertically underneath the jacking point **(A)**.
- ▶ Raise the vehicle until the defective wheel is clear of the ground. ▶

<sup>1)</sup> An adapter is required to unscrew or tighten the anti-theft wheel bolts ⇒ page 321.

**! WARNING**

- Make sure the jack\* is stable. If the ground underneath the jack\* is slippery or soft, the jack can slip or sink in - risk of injury!
- Use only the jack\* supplied with your vehicle to raise the vehicle. If you use a jack from a different vehicle, your vehicle may slip off the jack - risk of injury!
- Apply the jack\* only at the jacking points located behind the markings on the door sill and align it properly. Otherwise there is a risk of injury since the jack\* can slip off suddenly if it is not properly engaged.
- The height of the parked vehicle can change as a result of variations in loading.
- Never start the engine when the vehicle is on the jack - risk of accident!
- If work has to be done under the vehicle, ensure that it is safely supported on suitable stands - risk of injury!

**! CAUTION**

The vehicle must not be lifted up on its sills. Only apply the jack\* at the jacking points located behind the markings on the door sill. Otherwise your vehicle could be damaged.

**Taking off / putting on the wheel**



Fig. 264 Wheel: Hexagonal socket for turning wheel bolts

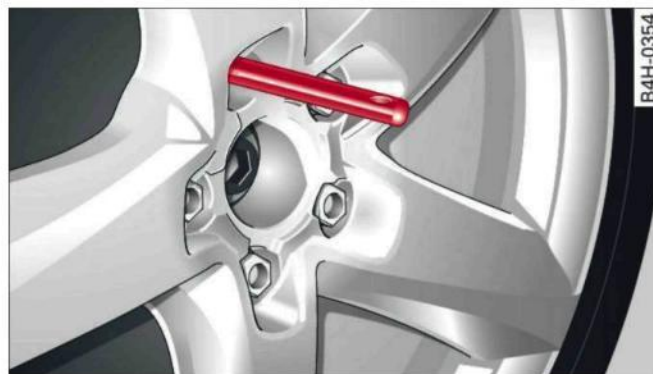

Fig. 265 Wheel: Mounting pin in wheel bolt hole nearest to the top

**Taking off the wheel**

- ▶ Using the hexagonal socket in the screwdriver handle (provided in the vehicle's tool kit), unscrew the top wheel bolt and place it on a clean surface ⇒ Fig. 264.
- ▶ Screw in the mounting pin (provided in the vehicle's tool kit) by hand in place of the wheel bolt ⇒ Fig. 265.
- ▶ Then unscrew the other wheel bolts.
- ▶ Take off the wheel ⇒ !. The mounting pin stays where it is.

**Putting on the wheel**

When putting on a tyre with directional tread pattern, refer to ⇒ page 324.

- ▶ Put on the wheel, using the mounting pin to guide it into place ⇒ !.
- ▶ Screw in the wheel bolts and tighten them lightly using the hexagonal socket.
- ▶ Then unscrew the mounting pin and tighten the remaining wheel bolt lightly.
- ▶ Carefully lower the car with the jack\*.
- ▶ Tighten the wheel bolts in diagonal sequence with the box spanner.

The wheel bolts should be clean and turn easily. Before putting on the wheel, inspect the condition of the wheel and hub mounting surfaces. These surfaces must be clean before mounting the wheel.

**! WARNING**

Do not use the hexagonal socket in the screwdriver handle to tighten the wheel bolts. It is

not possible to tighten the bolts to the required torque using the hexagonal socket - risk of accident!

### CAUTION

When removing/fitting the wheel the rim may hit and damage the brake disc. For this reason, please take care and get a second person to assist you.

### Note

The wheel bolts are easier to remove from the wheel rim if you use the hexagonal socket in the screwdriver handle. The reversible screwdriver blade should be removed as a precautionary measure when the tool is used for this purpose.

### Tyres with directional tread pattern

A directional tread pattern can be identified by arrows on the sidewall that point in the direction of rotation. Always note the direction of rotation indicated when mounting the wheel. This is important so that these tyres can give maximum grip and avoid excessive noise, tread wear and aquaplaning.

If you ever have a puncture and need to fit the spare wheel\* in the wrong direction, please drive with extra care because the tyre will not give optimum performance in this situation. Bear this in mind particularly when driving on wet roads.

To benefit from the advantages of tyres with this type of tread pattern, the defective tyre should be replaced and refitted as soon as possible so that all tyres again rotate in the correct direction.

### After changing a wheel

- ▶ Fit the hubcap or wheel bolt caps back on, as required.
- ▶ Put the tools and jack back in the luggage compartment.
- ▶ If the replaced wheel will not fit into the spare wheel well, stow it safely in the luggage compartment ⇒ *page 272*.

- ▶ Check the tyre pressure of the fitted wheel as soon as possible.
- ▶ On vehicles with tyre pressure loss indicator, adjust the tyre pressures and store them via the infotainment system ⇒ *page 311*.
- ▶ The wheel bolts should be tightened to 140 Nm. Have this checked as soon as possible with a torque wrench. Until then, drive with caution.
- ▶ Have the flat tyre replaced as quickly as possible.

## Spare wheel

### General notes

Applies to: vehicles with compact temporary spare wheel



Fig. 266 Luggage compartment: Floor panel folded up



Fig. 267 Compact temporary spare wheel (example)

The compact temporary spare wheel ⇒ *Fig. 267* is only intended for temporary use over short distances. Have the damaged wheel checked as soon as possible by a qualified workshop and, if necessary, replaced.

Please note the following restrictions when using the compact temporary spare wheel. The compact temporary spare wheel is designed specifically for this model. For this reason, do not use a spare wheel from a different type of vehicle. ▶



## Removing the spare wheel

- ▶ Lift the floor panel up by the plastic handle until the panel is fixed in position behind the retaining tabs on the two side sections ① ⇒ Fig. 266.
- ▶ Applies to vehicles with bass box in spare wheel well: Remove the bass box\*. Please first check the connector to establish which bass box is fitted in your vehicle: version 1) ⇒ page 325 or version 2) ⇒ page 326.
- ▶ Turn the plastic knob anti-clockwise.
- ▶ Take out the spare wheel.

## Snow chains

For technical reasons, snow chains must not be used on the compact temporary spare wheel.

Should you have a puncture on one of the front wheels when using snow chains, fit the compact temporary spare wheel in place of one of the rear wheels. You can then attach the snow chains to the wheel taken from the rear and use this wheel to replace the punctured front wheel.

### WARNING

- The tyre pressure must be checked as soon as possible after fitting the spare wheel – an incorrectly inflated tyre can increase the risk of accident. You can find the tyre pressures here ⇒ page 307, Fig. 253.
- Do not drive faster than 80 km/h when the compact temporary spare wheel is fitted – higher speeds can cause an accident.
- Avoid heavy acceleration, hard braking and fast cornering when the compact temporary spare wheel is fitted – risk of accident!
- Never use two or more compact spare tyres at the same time – risk of accident!
- No other type of tyre (normal summer or winter tyres) may be fitted on the compact temporary spare wheel.

## Removing the bass box (version 1)

Applies to: vehicles with bass box in spare wheel well

You must remove the bass box before you can take out the spare wheel\*.

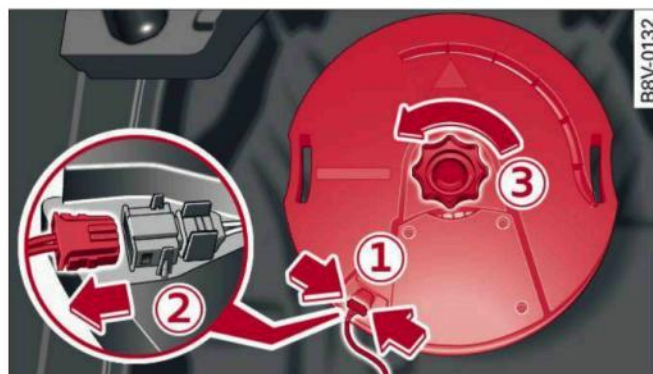

Fig. 268 Spare wheel well: Bass box

## Removing the bass box

- ▶ Lift the floor panel ⇒ page 324, Fig. 266.
- ▶ Compress the retaining tabs ① ⇒ Fig. 268 on the connector.
- ▶ Unplug the connector ② and move the disconnected cable clear to one side.
- ▶ Unscrew bolt ③.
- ▶ Carefully take out the bass box.

## Installing the bass box

- ▶ Carefully place the bass box in the well of the rim. Make sure that the inscription “FRONT” on the bass box points to the front of the vehicle.
- ▶ Plug the connector back in again.
- ▶ Secure the bass box with the screw.
- ▶ Fold the floor panel back down.

### Note

The bass box can be fitted even if there is no wheel in the spare wheel well.

### Removing the bass box (version 2)

Applies to: vehicles with bass box in spare wheel well

*You must remove the bass box before you can take out the spare wheel\*.*

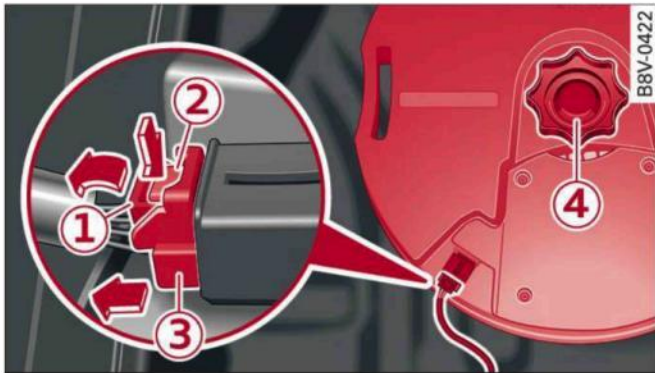

Fig. 269 Spare wheel well: Bass box

### Removing the bass box

- ▶ Lift the floor panel ⇒ page 324, Fig. 266.
- ▶ Pull the catch ① ⇒ Fig. 269 towards the cable.
- ▶ Press the retaining tab ② down.
- ▶ Unplug the connector ③ and move the disconnected cable clear to one side.
- ▶ Unscrew bolt ④.
- ▶ Carefully take out the bass box.

### Installing the bass box

- ▶ Carefully place the bass box in the well of the rim. Make sure that the inscription “FRONT” on the bass box points to the front of the vehicle.
- ▶ Plug the connector back in again.
- ▶ Push the catch ① back towards the bass box.
- ▶ Secure the bass box with the screw.
- ▶ Fold the floor panel back down.

#### **i** Note

The bass box can be fitted even if there is no wheel in the spare wheel well.

## Jump-starting

### Before starting the engine

*If necessary, the engine can be started by connecting it to the battery of another vehicle.*

If the engine fails to start because of a discharged battery, the vehicle battery can be connected to the battery of another vehicle to start the engine. Suitable jump leads are required.

Both vehicle batteries must be rated at 12 V. The capacity (Ah) of the booster battery should not be significantly lower than that of the discharged battery.

### Jump leads

The jump leads must be heavy enough to carry the starter current. Refer to the details given by the manufacturer.

Only use jump leads with insulated battery clamps.

Positive cable – usually red.

Negative cable – usually black.

#### **!** WARNING

- When it is discharged the vehicle battery can freeze at temperatures around 0°C. A frozen vehicle battery must first be thawed out before connecting the jump leads - risk of explosion and chemical burns! After jump-starting the vehicle, drive to a qualified workshop without delay and have the vehicle battery checked.
- The engine compartment is a potentially hazardous area and working here can lead to serious injuries. Before carrying out any work in the engine compartment please read and observe the warnings ⇒ page 295.
- Incorrect handling of the jump leads may result in the vehicle battery exploding (risk of serious injury). Please observe the following rules to minimise the risk of injury:
  - The non-insulated parts of the battery clamps must not be allowed to touch. The jump lead attached to the positive terminal must not touch metal parts of the vehicle: this can cause short circuiting.
  - Position the jump leads in such a way that they cannot come into contact with any moving parts in the engine compartment.
  - Do not lean over the vehicle battery - risk of chemical burns!
  - The screw plugs on the battery cells must be screwed in firmly.

- Keep sparks, flame and lit cigarettes away from vehicle batteries: the gases given off can cause an explosion.
- Do not attach the negative cable to parts of the fuel system or to the brake pipes.

**! CAUTION**

- The vehicles must not touch each other, otherwise electricity could flow as soon as the positive terminals are connected and the boosting battery could be discharged.
- If the jump leads are not connected correctly this can result in serious damage to the electrical system of the vehicle.
- The discharged vehicle battery must be properly connected to the vehicle's electrical system.
- Please note that the method described below for connecting the leads is intended for jump-starting your vehicle. If jump-starting another vehicle, you should not connect the negative lead (-) to the negative terminal of the discharged battery, but directly to the engine block or a solid metal part bolted to the engine block. If the battery of the other vehicle does not have a gas vent, there is a risk that a mixture of oxygen and hydrogen gas can accumulate and cause an explosion.

**i Note**

Switch off the car telephone if necessary. Details will be given in the manufacturer's instructions for the car telephone.

**Starting the engine**

The two jump leads must be connected in the correct sequence.

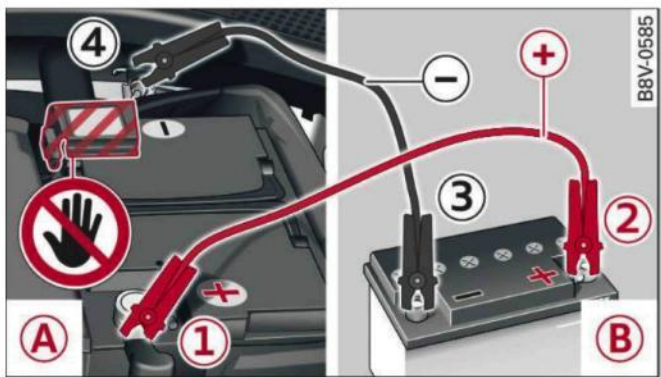

Fig. 270 Jump-starting with the vehicle battery of another vehicle: (A) - Discharged battery, (B) - Boosting battery

The vehicle battery is located at the front left of the engine compartment. Open the cover to access the positive terminal of the vehicle battery. Please note that the described method of connecting the leads is meant for jump-starting your vehicle.

Please observe the general notes on the vehicle battery ⇒ page 302.

**Preparations**

1. Please read ⇒ page 326, *Before starting the engine* carefully before proceeding.
2. Apply the parking brake and move the gear lever to neutral (on vehicles with manual gearbox) or move the selector lever to P (on vehicles with automatic gearbox).
3. Switch off all electrical equipment and the ignition on both vehicles.

**Connecting and disconnecting the jump leads**

4. Open the battery cover.
5. Connect one end of the red jump lead to the positive terminal ① ⇒ Fig. 270 of the discharged battery (A) ⇒ ! in *Before starting the engine* on page 327.
6. Connect the other end of the red jump lead to the positive terminal ② of the boosting battery (B).

7. Connect one end of the black lead **preferably to the earth point** or alternatively to the negative battery terminal ③ on the vehicle providing assistance ②.
8. Connect the other end of the black jump lead **only to the earth point** ④ of the jump-start connection on **your vehicle** ① ⇒ ⚠.
9. Position the jump leads in such a way that they cannot come into contact with any moving parts in the engine compartment.

### Starting the engine

10. Start the engine of the vehicle with the boosting battery and let it run at idling speed.
11. Start the engine of the car with the discharged battery and wait two or three minutes until the engine is running smoothly.
12. If the engine fails to start: do not operate the starter for longer than 10 seconds. Wait for about 30 seconds and try again.
13. Switch on the blower and the rear window heating on the vehicle which has been jump-started in order to offset excessive voltage which may occur when disconnecting the leads. The headlights must be switched off!
14. Disconnect the leads in exactly the *opposite* sequence to that described in ⇒ *page 327* with the engines running. Make sure that the leads cannot come into contact with any moving parts in the engine compartment.
15. Fold the cover back onto the battery in its correct position.
16. Switch off the blower and the rear window heating again.

Please refer to ⇒ ⚠ in *Before starting the engine on page 326* and ⇒ ⚠ in *Before starting the engine on page 327*.

### ⚠ CAUTION

Do not use the negative battery terminal when jump-starting (this could cause a malfunction in the on-board electrical system).

### ⓘ Note

- Connect the battery clamps so they have good metal-to-metal contact with the battery terminals.
- The vehicle battery is vented to the outside to prevent gases entering the vehicle's interior.

## Tow-starting / towing away

### General notes

Some experience is required to tow or tow-start a vehicle, especially when using a tow-rope. Both drivers should be familiar with the technique required for towing. Inexperienced drivers should not attempt to tow-start or tow away another vehicle.

Do not pull too hard with the towing vehicle and take care to avoid jerking the tow-rope. When towing off-road, there is always a risk that the anchorage points may be overloaded.

### Tow-bar / tow-rope

It is easier and safer to tow the vehicle with a tow-bar. You should only use a tow-rope if you do not have a tow-bar. It is advisable to use a tow-rope made of elastic synthetic fibre or similarly elastic material.

### Notes on towing vehicles

The vehicle can be towed with a tow-bar or tow-rope. When the engine is not running, the gearbox will not be adequately lubricated if the following speed/distance restrictions are not observed:

- The vehicle must not be towed faster than 50 km/h.
- The vehicle must not be towed further than 50 km.

### Additional notes on towing by breakdown truck

If one of the axles has to be raised in order to tow the vehicle, please refer to the following table to determine the appropriate axle for your gearbox/drive combination:

|                          | Front-wheel drive  | Four-wheel drive   |
|--------------------------|--------------------|--------------------|
| <b>Manual gearbox</b>    | Front or rear axle | Front or rear axle |
| <b>Automatic gearbox</b> | Front axle         | Front axle         |

Applies to vehicles with four-wheel drive: If the vehicle is to be towed with one of the axles raised, the ignition must be switched off; otherwise the drive train can be damaged.

#### Notes on tow-starting

Applies to vehicles with automatic gearbox: For technical reasons, your vehicle must not be tow-started.

Applies to vehicles with manual gearbox: As a general rule, tow-starting is not recommended. If the engine will not start, it is best to try starting it using the battery of another vehicle ⇒ *page 326* before attempting to tow start. If this is not possible, you can try to push-start or tow-start the vehicle ⇒ *page 330, Tow-starting*.

#### WARNING

There is a high risk of accidents when towing/tow-starting, as the towed vehicle can easily be driven into the towing vehicle.

#### CAUTION

- If it is not possible to tow the vehicle as described above (e.g. due to a gearbox failure or if the vehicle has to be towed further than 50 km), it must be transported on a special car transporter or trailer.
- Towing a vehicle with the wrong axle raised can cause serious damage to the gearbox.

#### Note

- Applies to vehicles with automatic gearbox: It is not possible to move the selector lever out of position P if the electrical power supply fails. Before the vehicle can be recovered/manoeuvred you must manually release the selector lever; left-hand drive vehicles ⇒ *page 93*, right-hand drive vehicles ⇒ *page 94*.
- Please observe the relevant regulations when towing or tow-starting.

### Towing away

Please observe the important safety warnings on ⇒ *page 328*.

#### Preparations

- ▶ Attach the tow-rope or the tow-bar only to the towing anchorages provided for this purpose ⇒ *page 330*, ⇒ *page 331*.
- ▶ Please ensure that the tow-rope is not twisted as it could otherwise unscrew the towline anchorage while the vehicle is being towed.
- ▶ The hazard warning lights of both vehicles must normally be switched on ⇒ *page 52*. However, observe any regulations to the contrary.

#### Towing vehicle (front)

- ▶ Ensure that the tow-rope is taut before you drive off.
- ▶ Manual gearbox: Engage the clutch very gently when starting to move and accelerate with particular care.
- ▶ Automatic gearbox: Accelerate slowly and gradually.
- ▶ Avoid unnecessary braking and manoeuvres.

#### Vehicle being towed (rear)

- ▶ Ensure that the ignition is switched on, the steering wheel is not locked, and that you can operate the turn signals, horn or windscreen wipers if necessary ⇒ .
- ▶ The brake servo only works when the engine is running. The power steering only works when ▶

the ignition is on and the vehicle is moving<sup>1)</sup>. Otherwise you will need to press the brake pedal significantly harder and apply more force to move the steering wheel.

- ▶ Please ensure that the steering wheel is unlocked and that it moves freely.
- ▶ Release the parking brake ⇒ *page 82*.
- ▶ Applies to vehicles with manual gearbox: Put the gear lever in neutral.
- ▶ Applies to vehicles with automatic gearbox: Move the selector lever to position N.
- ▶ Ensure that the tow-rope remains taut at all times when towing.

### WARNING

If the vehicle has no electrical power, do NOT use a tow-bar or tow-rope to tow the vehicle

### Note

You can use the turn signals to indicate a change of direction (or lane) even when the hazard warning lights are on. The hazard warning lights will be interrupted temporarily.

## Tow-starting

Please observe the important safety warnings on ⇒ *page 328*.

Important: Your vehicle must be fitted with a manual gearbox. If your vehicle has a petrol engine, it must not be towed further than 50 metres ⇒ .

- ▶ Attach the tow-rope or the tow-bar only to the towing anchorages provided for this purpose ⇒ *page 330*, ⇒ *page 331*.
- ▶ Engage second or third gear before moving off.
- ▶ Press the clutch and hold the pedal down.
- ▶ Switch on the ignition.
- ▶ Once both vehicles are moving, release the clutch.
- ▶ As soon as the engine starts, press the clutch pedal and put the gear lever in neutral.

### CAUTION

When tow-starting the vehicle, do not tow it further than 50 metres; otherwise the catalytic converter could be damaged.

## Front towline anchorage



Fig. 271 Front bumper (right side): Removing cover cap



Fig. 272 Front bumper (right side): Towline anchorage screwed in

The screw connection for the towline anchorage is located behind a cover cap on the right side of the front bumper.

- ▶ Take the towline anchorage out of the vehicle's tool kit ⇒ *page 319*.
- ▶ Press the cover cap briefly but firmly inwards -arrow-, detach it from the bumper and take it out ⇒ *Fig. 271*.
- ▶ Screw the towline anchorage into the screw connection as far as it will go ⇒ *Fig. 272* and tighten it with the box spanner.
- ▶ Put the towline anchorage back in the tool kit after use. ▶

<sup>1)</sup> Important: The vehicle battery must be adequately charged.

**! WARNING**

If the towline anchorage is not screwed in as far as the stop, there is a risk of the screw connection shearing off during towing - risk of accident!

**Rear towline anchorage**

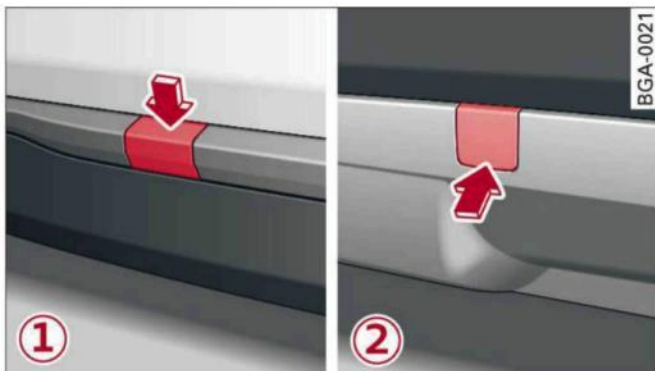

**Fig. 273** Rear bumper (right side): Removing cover cap (versions 1 and 2)



**Fig. 274** Rear bumper (right side): Towline anchorage screwed in

**Vehicles with towline anchorage**

On vehicles which do not have a factory-fitted towing bracket\*, a screw connection is located behind a cover cap on the right side of the rear bumper.

- ▶ Take the towline anchorage out of the vehicle tool kit ⇒ *page 319*.
- ▶ Press the cover cap briefly but firmly downwards ①/inwards ② -arrow-, detach it from the bumper and take it out ⇒ *Fig. 273*.
- ▶ Screw the towline anchorage into the screw connection as far as it will go ⇒ *Fig. 274* and tighten it with the box spanner.
- ▶ Put the towline anchorage back in the tool kit after use.

**Vehicles with towing bracket\***

The removable ball joint must be attached before you can use the towing bracket:

- ▶ Insert the ball joint ⇒ *page 99*.
- ▶ Attach the tow-bar or the tow-rope to the ball joint.

On some models, the shape of the cap can vary.

Vehicles which have a factory-fitted towing bracket\* do **not** have a screw connection at the rear for the towline anchorage.

**! WARNING**

If the towline anchorage is not screwed in as far as the stop, there is a risk of the screw connection shearing off during towing - risk of accident!

**! CAUTION**

To avoid damaging the towing bracket\*, only use tow-bars with suitable attachments. If a tow-bar is not available, a tow-rope may be used.

## Fuses and bulbs

### Fuses

#### Changing fuses

To see whether a fuse has blown, check whether the metal strip has melted.



Fig. 275 ① Steering column area (LHD vehicles): cover, ② Glove box (RHD vehicles): cover

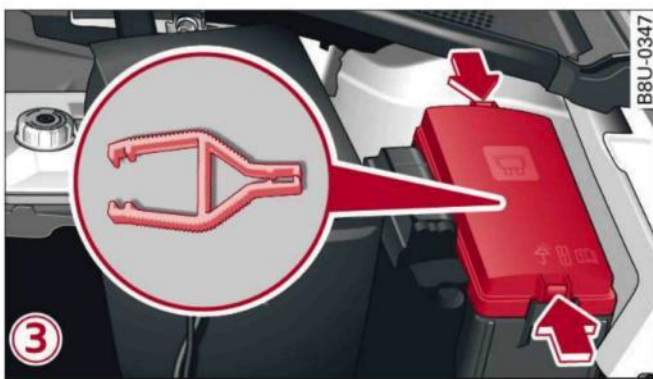

Fig. 276 ③ Engine compartment (left side): Fuse cover

The fuses are located behind a cover in the steering column area (on LHD vehicles) ① ⇒ Fig. 275 or behind a cover in the glove box (on RHD vehicles) ②. Further fuses are located beneath a cover in the engine compartment (left side) ③ ⇒ Fig. 276.

- ▶ Switch off the ignition and all electrical equipment.

- ▶ Refer to the following tables to identify the fuse for the failed component ⇒ page 333.
- ▶ Remove the appropriate cover.
- ▶ Take the plastic clip from inside the fuse cover in the engine compartment ⇒ Fig. 276.
- ▶ Use the plastic clip to pull out the fuse.
- ▶ Blown fuses should always be replaced with a fuse of the same rating.
- ▶ Replace the cover again.

#### Colour coding for fuses

| Colour               | Rating in amperes |
|----------------------|-------------------|
| black                | 1                 |
| purple               | 3                 |
| light brown          | 5                 |
| brown                | 7.5               |
| red                  | 10                |
| blue                 | 15                |
| yellow               | 20                |
| white or transparent | 25                |
| green                | 30                |
| orange               | 40                |

#### ⚠ WARNING

Never attempt to repair a fuse or replace a blown fuse by fitting a fuse with a higher amperage rating. This could damage the electrical system - risk of fire!

#### ⚠ CAUTION

If a newly replaced fuse blows again after a short time, the electrical system must be checked by a qualified workshop as soon as possible.

#### i Note

- Unassigned fuse locations are not shown in the tables below.
- Some of the items of equipment listed in the tables below are only fitted on certain models or are optional extras.



Fuses in vehicle interior

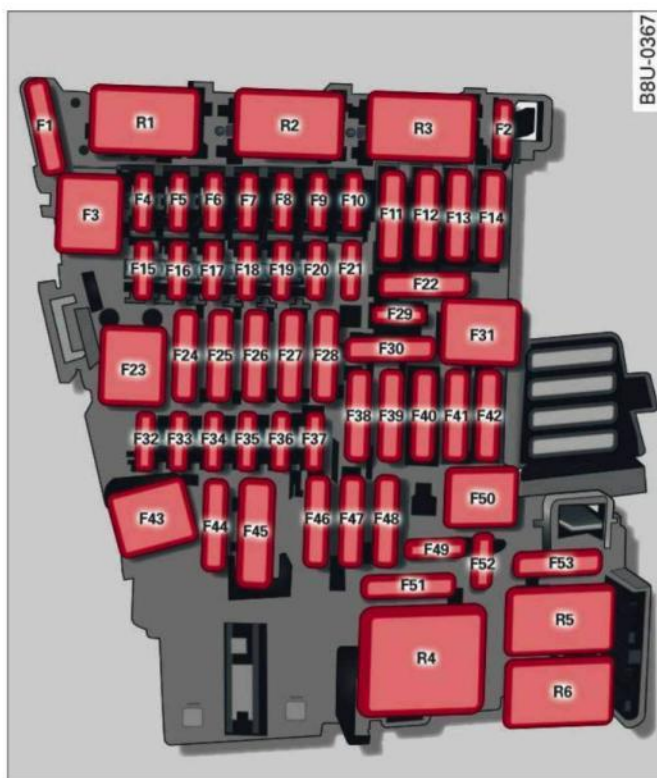

Fig. 277 Interior: Fuse layout

| No. | Electrical equipment  |
|-----|---|
| F1  | AdBlue engine components  |
| F2  | Seat adjuster   |
| F4  | Infotainment control console  |
| F5  | Gateway   |
| F6  | Selector lever (for automatic gearbox)  |
| F7  | Air conditioner/heater console, relay coil for rear window heating  |
| F8  | Switch for electro-mechanical parking brake, light switch, rain/light sensor, interior lighting, anti-theft alarm system, diagnostic connector, emergency call system |
| F9  | Steering column switch module   |
| F10 | Infotainment/head-up display  |
| F11 | Belt tensioners (driver's side)   |
| F12 | Infotainment components   |
| F13 | Control unit for suspension control   |
| F14 | Blower (heating system/air conditioner)   |
| F15 | Electric steering column lock   |
| F16 | Infotainment components   |
| F17 | Instrument cluster  |
| F18 | Reversing camera  |

| No. | Electrical equipment   |
|-----|--|
| F19 | Control unit for convenience access, park assist   |
| F20 | AdBlue engine components   |
| F22 | Power-operated boot lid  |
| F23 | Control unit for vehicle electrical system (right side)  |
| F24 | Panorama sun roof  |
| F25 | Front/rear door control unit, front/rear window switches   |
| F26 | Seat heating   |
| F27 | Sound amplifier  |
| F29 | Interior lights  |
| F31 | Control unit for vehicle electrical system (left side)   |
| F32 | Control unit for camera, radar sensor, park assist   |
| F33 | Airbag   |
| F34 | Button lighting for hold assist, interior sound, reversing light switch, temperature sensor, coil for electrical socket relay, button for hold assist      |
| F35 | Function lighting (halogen), headlight range control, air quality sensor, automatic anti-dazzle mirrors, diagnostic connector, centre console power supply |
| F36 | Right headlight (LED)  |
| F37 | Left headlight (LED)   |
| F39 | Front/rear door control unit, front/rear window switches   |
| F40 | Cigarette lighter, electrical sockets  |
| F41 | Belt tensioners (front passenger's side)   |
| F42 | Central locking system, windscreen washer  |
| F43 | Interior lights  |
| F44 | Four-wheel drive   |
| F47 | Rear window wiper  |
| F49 | Clutch sensor (relays 1+2)   |
| F53 | Rear window heating  |

The seats with electric adjustment\* are protected by **circuit breakers**. These reset automatically after a few seconds when the overload has been corrected.

**Fuses in engine compartment**



Fig. 278 Engine compartment: Fuse layout

| No. | Electrical equipment                          |
|-----|---|
| F18 | Battery monitoring, gateway                   |
| F19 | Windscreen wipers                             |
| F20 | Anti-theft alarm system                       |
| F22 | Terminal 50, diagnostics, engine control unit |
| F23 | Starter                                       |
| F24 | Supplementary heater heating rod 1            |
| F31 | Vacuum pump                                   |
| F33 | Automatic gearbox, gearbox oil pump           |

**Bulbs**

**General notes**

*Changing bulbs requires a certain degree of practical skill.*

LED\* lights are maintenance-free and cannot be changed. For repairs, please contact a qualified workshop.

If you decide to change bulbs in the engine compartment yourself, be aware of the safety risks involved ⇒ ⚠ *in Working on components in the engine compartment on page 295.*

**⚠ WARNING**

- Take particular care when working on components in the engine compartment if the engine is warm - risk of burns!
- Bulbs are sensitive to pressure. The glass can break when you touch the bulb, causing injury.
- When changing bulbs, please take care not to injure yourself on sharp edges, in particular on the headlight housing.

**⚠ CAUTION**

- Always switch off the ignition before carrying out any work on the electrical system - danger of short circuiting!
- Switch off the lights or parking lights before you change a bulb.
- Take good care to avoid damaging any components.

| No. | Electrical equipment  |
|-----|---|
| F1  | Electronic stabilisation control (ESC)  |
| F2  | Electronic stabilisation control (ESC)  |
| F3  | Engine control unit   |
| F4  | Engine components, engine cooling, supplementary heater relay coils (1+4+7), secondary air pump relay |
| F5  | Engine components, tank system (diesel)   |
| F6  | Brake light sensor  |
| F7  | Engine components, coolant pumps, tank system (petrol)  |
| F8  | Lambda probe  |
| F9  | Engine components, exhaust flap, control unit for automatic glow period (relay 6)                     |
| F10 | Fuel control unit, fuel pump  |
| F11 | Supplementary heater heating rod 2  |
| F12 | Supplementary heater heating rod 3  |
| F13 | Automatic gearbox   |
| F15 | Horn  |
| F16 | Ignition coil (relay 8)   |
| F17 | Electronic stabilisation control (ESC), engine control unit (relay 5)                                 |

- Make sure that the covers are correctly seated on the headlights and the rear lights. This will ensure that water cannot enter the housings and cause the lights to malfunction.
- Do not touch the glass part of the bulb with your bare hands; use a cloth or paper towel instead. Otherwise, the fingerprints left on the glass will vaporise as a result of the heat generated by the bulb, be deposited on the reflector and impair its surface.

**! CAUTION**

When removing or installing the rear light, take care not to cause any damage.

- Removing the rear light in particular can lead to the paintwork or rear light becoming damaged. This is another reason why we recommend having the bulbs changed by a qualified workshop.
- Never use metal tools (e.g. a screwdriver) or sharp or pointed plastic tools to lever out the rear light – risk of damaging the paint.
- Make sure you have a soft cloth ready to place under the glass on the rear light, to avoid any scratches.

**🌱 For the sake of the environment**

A qualified workshop can advise you how to dispose of used bulbs in the proper manner.

**i Note**

- Please check at regular intervals that all lighting (especially the exterior lighting) on your vehicle is functioning properly. This is not only in the interest of your own safety, but also in that of all other road users.
- Before changing a bulb, make sure you have the correct new bulb.

**Bulbs at front of vehicle**

Applies to: vehicles with halogen headlights



Fig. 279 Halogen headlights: Overview of left side of vehicle

You must only replace a bulb with a bulb of the same type. Information regarding e.g. the wattage can be found on the base of the bulb.

The description for changing the bulb refers to the left headlight; the procedure for the right headlight is similar.

**Halogen headlights**

The following bulbs can be changed:

| Bulb (12 V)             | Version      |
|-------------------------|--------------|
| ① Main beam headlight   | H7 LL (55 W) |
| ② Dipped headlight      | H7 LL (55 W) |
| ③ Daytime running light | PW24W        |
| ④ Turn signal           | PWY24W       |

**Bulbs at rear of vehicle**

Applies to: vehicles with bulbs



Fig. 280 Rear of vehicle: Bulbs on left side of vehicle

## Fuses and bulbs

You must only replace a bulb with a bulb of the same type. Information regarding e.g. the wattage can be found on the glass or base of the bulb.

The description for changing the bulb refers to the left rear light unit; the procedure for the right rear light unit is similar.

You can change the following bulbs yourself:

| Bulb (12 V)                    | Version |
|--------------------------------|---------|
| ① Tail light                   | W16W    |
| ② Brake light                  | P21W    |
| ③ Reversing light              | W16W    |
| ④ Turn signal                  | PY21W   |
| ⑤ Rear fog light <sup>a)</sup> | W16W    |

a) The bulb for the rear fog light is fitted on one side only. It is located on the left side on LHD vehicles and on the right side on RHD vehicles.

## Changing headlight bulbs

### Removing cover (engine compartment)

Applies to: vehicles with halogen headlights



Fig. 281 Headlight: Cover for turn signal and main beam headlight

- ▶ Switch off the ignition and the lights.
- ▶ Open the bonnet.
- ▶ Turn the headlight cover anti-clockwise ⇒ Fig. 281 and remove it ⇒ ⚠ in General notes on page 334.
- ▶ Change the bulb for the turn signal ⇒ page 336 or the main beam headlight ⇒ page 337.

### Changing bulb for turn signals

Applies to: vehicles with halogen headlights

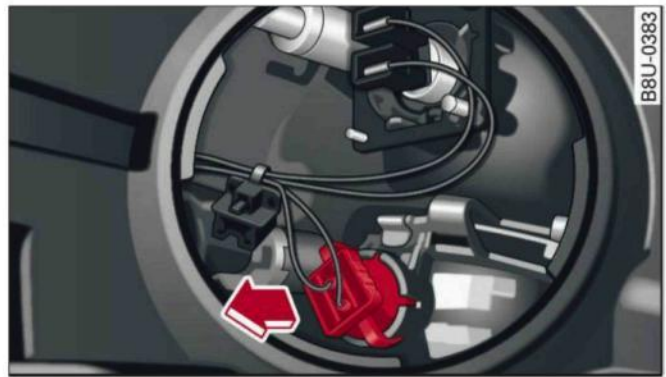

Fig. 282 Headlight: Plastic connector for turn signal

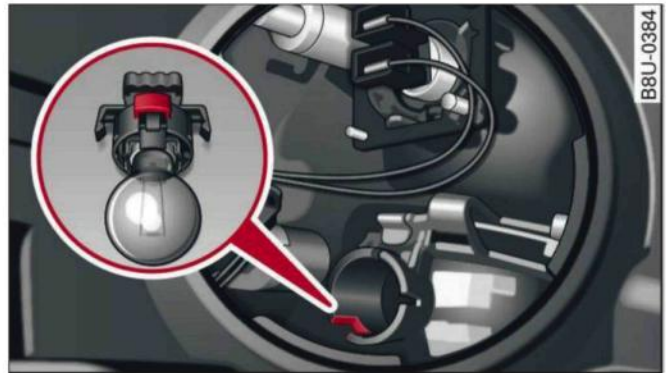

Fig. 283 Headlight: Fitting plastic connector for turn signal

### Removing

- ▶ Pull the plastic connector together with the bulb out of the headlight housing ⇒ Fig. 282.
- ▶ Disconnect the plastic connector from the base of the bulb ⇒ ⚠ in General notes on page 334.

### Installing

- ▶ Push the new bulb into the plastic connector so that it is securely seated ⇒ ⚠ in General notes on page 334.
- ▶ Insert the bulb into the headlight housing.
- ▶ Fit the plastic connector ⇒ Fig. 283 into the housing and press it in until the side catches engage.
- ▶ Put the cover back on.
- ▶ Check whether the new bulb is working.

**Changing bulb for main beam headlight**

Applies to: vehicles with halogen headlights



**Fig. 284** Headlight: Plastic connector for main beam headlight

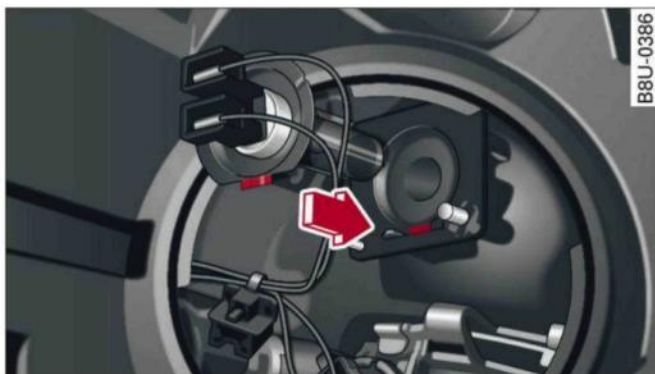

**Fig. 285** Headlight: Fitting plastic connector for main beam headlight

**Removing**

- ▶ Pull the plastic connector together with the bulb out of the headlight housing ⇒ *Fig. 284*.
- ▶ Disconnect the plastic connector from the base of the bulb ⇒ ⚠ in *General notes on page 334*.

**Installing**

- ▶ Push the new bulb into the plastic connector so that it is securely seated ⇒ ⚠ in *General notes on page 334*.
- ▶ Insert the bulb into the headlight housing.
- ▶ Press the plastic connector ⇒ *Fig. 285* into the housing until it engages.
- ▶ Check that the bulb is seated correctly by looking through the headlight itself.
- ▶ Put the cover back on.
- ▶ Check whether the new bulb is working.

**Removing cover (wheel housing liner)**

Applies to: vehicles with halogen headlights



**Fig. 286** Wheel housing liner: Access to daytime running light and dipped headlight bulbs

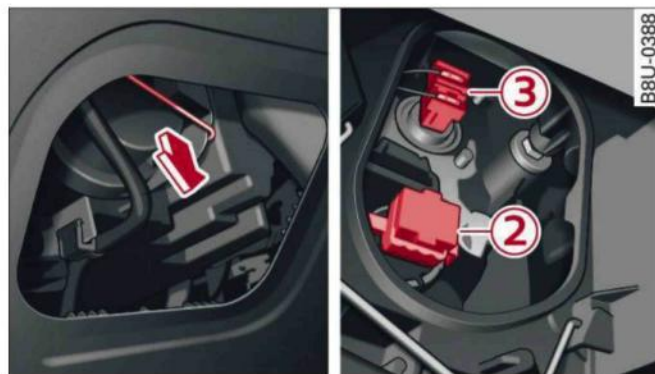

**Fig. 287** Headlight: Cover for daytime running light and dipped headlight

- ▶ Turn the steering all the way to the right.
- ▶ Switch off the ignition and the lights.
- ▶ Reach into the opening ① ⇒ *Fig. 286* and pull in the direction of the arrow to open the cover in the wheel housing liner.
- ▶ Move the metal bar downwards -arrow- ⇒ *Fig. 287* and remove the plastic cover ⇒ ⚠ in *General notes on page 334*.
- ▶ Change the bulb for the daytime running light ② ⇒ *page 338* or the dipped headlight ③ ⇒ *page 338*.

### Changing bulb for daytime running light

Applies to: vehicles with halogen headlights

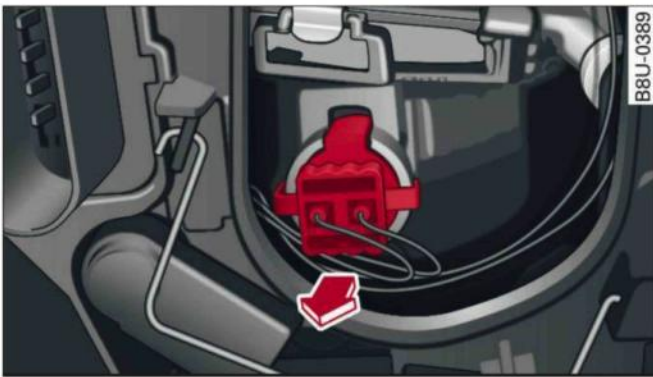

Fig. 288 Wheel housing liner: Plastic connector for daytime running light

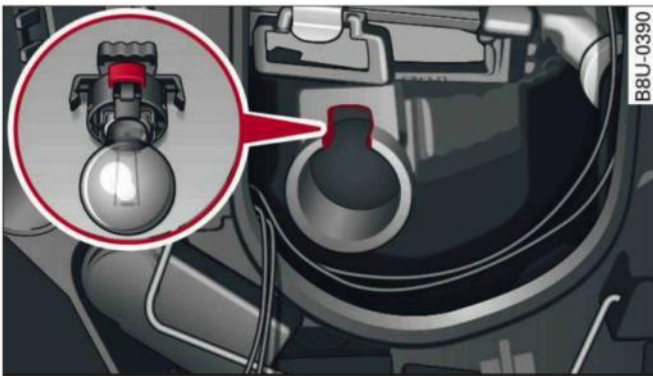

Fig. 289 Wheel housing liner: Fitting plastic connector for daytime running light

### Removing

- ▶ Pull the plastic connector together with the bulb out of the headlight housing ⇒ Fig. 288.
- ▶ Disconnect the plastic connector from the base of the bulb ⇒ ⚠ in General notes on page 334.

### Installing

- ▶ Push the new bulb into the plastic connector so that it is securely seated ⇒ ⚠ in General notes on page 334.
- ▶ Insert the bulb into the headlight housing.
- ▶ Press the plastic connector ⇒ Fig. 289 into the housing until it engages.
- ▶ Put the covers back on the headlight and the wheel housing liner.
- ▶ Check whether the new bulb is working.

### Changing bulb for dipped headlight

Applies to: vehicles with halogen headlights

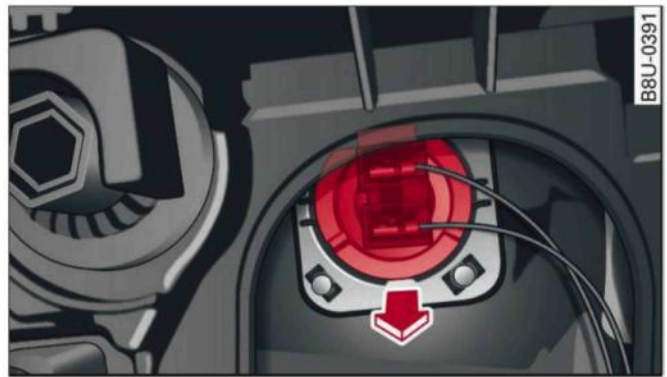

Fig. 290 Wheel housing liner: Plastic connector for dipped headlight

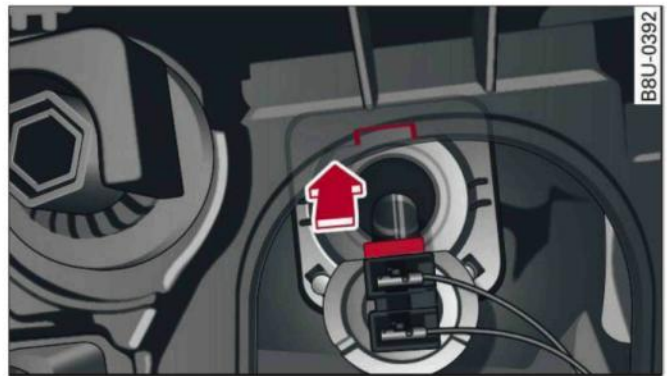

Fig. 291 Wheel housing liner: Fitting plastic connector for dipped headlight

### Removing

- ▶ Pull the plastic connector together with the bulb out of the headlight housing ⇒ Fig. 290.
- ▶ Disconnect the plastic connector from the base of the bulb ⇒ ⚠ in General notes on page 334.

### Installing

- ▶ Push the new bulb into the plastic connector so that it is securely seated ⇒ ⚠ in General notes on page 334.
- ▶ Insert the bulb into the headlight housing.
- ▶ Press the plastic connector ⇒ Fig. 291 into the housing until it engages.
- ▶ Check that the bulb is seated correctly by looking through the headlight itself.
- ▶ Put the covers back on the headlight and the wheel housing liner.
- ▶ Check whether the new bulb is working.

## Changing bulbs for rear lights

### Preparations

Applies to: vehicles with bulbs

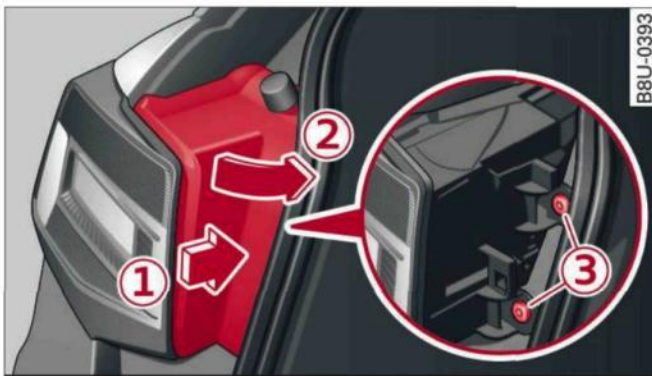

Fig. 292 Side panel: Removing cover



Fig. 293 Removing rear light from body panel

- ▶ Check which of the bulbs is defective.
- ▶ Switch off the ignition and the lights.
- ▶ Open the boot lid.
- ▶ Take the screwdriver, the interchangeable Torx bit and the removal wedge out of the vehicle tool kit ⇒ *page 319*.
- ▶ To remove the cover, press it in the direction of the arrow ① ⇒ *Fig. 292* and then swivel it away to the side with your hand ②.
- ▶ Remove the securing screws ③ using the Torx screwdriver.
- ▶ Carefully slide the removal wedge ④ into the gap between the body and the rear light ⇒ *Fig. 293*, ⇒ ⚠ in *General notes on page 335*.
- ▶ Gradually ease out the rear light by pulling alternately in direction of arrows ⑤ and ⑥.
- ▶ Unplug the electrical connector.
- ▶ Change the defective bulb ⇒ *page 339*.

### Changing a bulb

Applies to: vehicles with bulbs

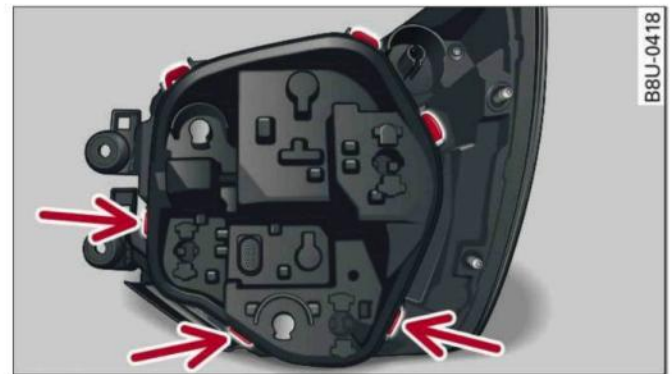

Fig. 294 Rear light: Release points on bulb carrier

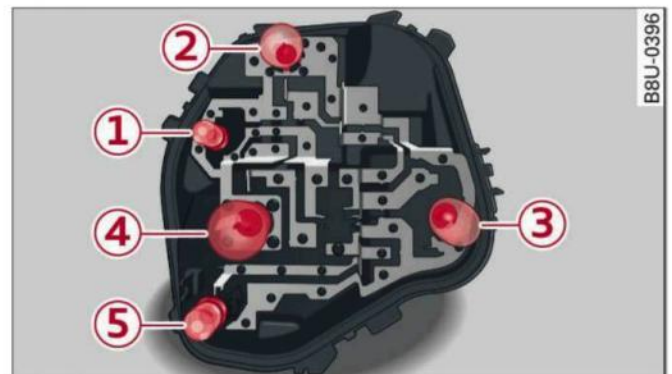

Fig. 295 Bulb carrier: Position of the bulbs

- ▶ Remove the clips securing the bulb carrier ⇒ *Fig. 294*. Start with the three clips at the bottom -arrows-.
- ▶ Detach the bulb carrier ⇒ *Fig. 295*.
- ▶ Renew the defective bulb (pull to remove from plug-in holder or turn to remove from bayonet holder).
- ▶ Attach the bulb carrier.
- ▶ Re-install all the parts in the reverse sequence.
- ▶ Check whether the new bulb is working.

### Position of bulbs

| Position<br>⇒ <i>Fig. 295</i> | Bulb function   |
|-------------------------------|-----------------|
| ①                             | Tail light      |
| ②                             | Brake light     |
| ③                             | Reversing light |
| ④                             | Turn signal     |
| ⑤                             | Rear fog light  |

## Accessories and modifications to the vehicle

### Accessories, replacement parts and repairs

*Always ask your dealer or specialist retailer for advice before purchasing accessories and replacement parts.*

Your car is designed to offer a high standard of active and passive safety. For this reason, we recommend that you ask your Audi dealer for advice before fitting accessories or replacement parts. Audi dealers have the latest information from the manufacturer and can recommend accessories and replacement parts which are suitable for your requirements. They can also answer any questions you might have regarding official regulations.

We recommend you to use only **Audi accessories** and **Audi Genuine Parts**. Audi has tested these products for suitability, reliability and safety. Audi dealers have the necessary experience and facilities to ensure that the parts are installed properly.

Although the market is constantly scrutinised, Audi cannot judge or assume responsibility for the reliability, safety and suitability of non-genuine products - even though in some instances, these parts may have been approved by an officially recognised technical testing authority or accompanied by an official approval certificate.

Any **retro-fitted equipment** which has a direct effect on the vehicle and/or the way it is driven (e.g. cruise control system or electronically-controlled suspension) must be approved for use in your vehicle and bear the **e** mark (the European Union's approval symbol).

If any **additional electrical components** are fitted which do not serve to control the vehicle itself (for instance a refrigerator box, laptop or ventilator fan, etc.), these must bear the **CE** mark (manufacturer conformity declaration in the European Union).

#### WARNING

Never attach accessories (such as cup holders or telephone brackets) to the surfaces covering the airbag units or the areas around the airbags: this could cause injury if the airbag is triggered.

### Modifications

*Modifications must always be carried out according to our specifications.*

Unauthorised modifications to the electronic components, software, wiring or data transfer in the vehicle may cause malfunctioning. Due to the way the electronic components are linked together in networks, other systems may be affected by the faults. This can seriously impair safety, lead to excessive wear of components, and also invalidate the type approval for your vehicle.

You will appreciate that your Audi dealer cannot be held liable for any damage caused by modifications and/or work performed incorrectly.

We recommend that all work should be performed by an Audi workshop using **Audi Genuine Parts**.

#### WARNING

- Incorrectly performed modifications or other work on your vehicle can lead to malfunctions and cause accidents.
- Do not use an additional or replacement number plate holder other than the original one fitted at the front of the vehicle.

### Radio transmitters and business equipment

#### Transmitters

An external aerial is required in order to operate radio equipment inside the vehicle. The maximum range of the equipment can only be achieved with an external aerial.

Retrofit installations of radio transmitters in the vehicle are subject to official approval and can affect the type approval for your vehicle. In



extreme cases this could mean that you lose the type approval for your vehicle.

Qualified workshops will be able to inform you about options for installing and operating radio transmitters.

### Business equipment

Retrofit installation of business or other equipment in the vehicle is permitted, provided the equipment cannot interfere with the driver's immediate control of the vehicle. Any such equipment must carry the **CE** mark. Any retrofit equipment that could influence the driver's control of the vehicle must have a type approval for road vehicles and must carry the **e** mark.



#### WARNING

- Loose or incorrectly secured radio equipment could be catapulted through the vehicle during sudden driving/braking manoeuvres or in the event of an accident. This poses a risk of injury to occupants.
- Always ensure that radio equipment is properly secured outside the deployment area of the airbags or stowed safely while the vehicle is moving.
- Mobile telephones or radio equipment which are operated inside the vehicle without a correctly installed external aerial can create excessive magnetic fields that could cause a health hazard.



#### CAUTION

- If you use radio equipment in the car without an external aerial, the electromagnetic radiation in the vehicle could exceed the recommended limits. This also applies to external aerials which have not been correctly installed.
- Do not operate radio equipment in the vehicle unless an external aerial is properly connected.



#### Note

Please observe the relevant regulations and follow the instructions in the operating manual for the radio equipment.

## Technical data

### Vehicle identification data

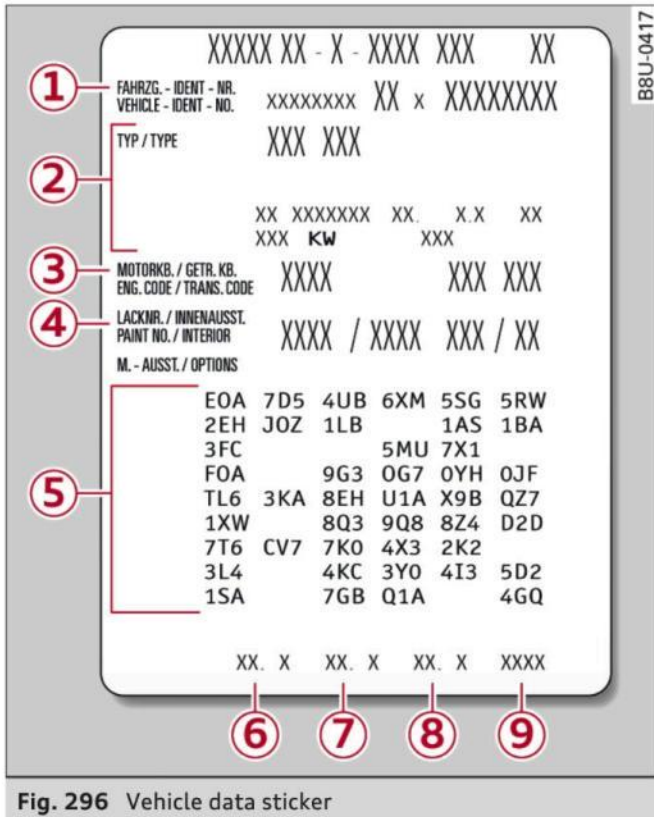

Fig. 296 Vehicle data sticker

#### Chassis number

The chassis number can be found at the following locations:

- Select the following on the infotainment system\*: **MENU** button > **Car** > left control button > **Servicing & checks** > **Car information**.
- On the vehicle data sticker
- Under the windscreen on the driver's side\*
- On the right side of the engine compartment

#### Type plate

The type plate is located on the right door pillar. Vehicles for certain export countries have no type plate.

#### Vehicle data sticker

The vehicle data sticker ⇒ Fig. 296 is under the carpet trim in the luggage compartment in the

spare wheel well. One section of the vehicle data sticker is attached to the inside cover of the Service Schedule before the vehicle is handed over.

The sticker lists the following data:

- ① Vehicle identification number (chassis number)
- ② Vehicle type / engine power / gearbox type
- ③ Engine and gearbox code letters
- ④ Paint No. / Interior equipment No.
- ⑤ Optional equipment codes

#### Fuel consumption and emissions<sup>1)</sup>

Information on the vehicle's fuel consumption and emissions is given at the bottom of the vehicle data sticker:

- ⑥ Urban cycle consumption (ltr./100 km)
- ⑦ Extra-urban cycle consumption (ltr./100 km)
- ⑧ Combined cycle consumption (ltr./100 km)
- ⑨ Combined CO<sub>2</sub> emissions (g/km)

The specified values were determined in accordance with the required test procedures. The figures do **not** refer to a particular individual vehicle, but are intended solely as a basis for comparison between different types of vehicle. The actual consumption may be different and depends, in particular, on special equipment, vehicle loading, driving style, road and traffic conditions, environmental conditions and the state of the vehicle.

### Explanation of technical data

The figures for some markets may vary due to special equipment as well as different export versions and test methods.

Please note that the details listed in the vehicle's registration documents can be taken as correct. ►

<sup>1)</sup> All the figures are not available for all export versions. In this case, the fields contain place holders, for example 99.9.

**i Note**

In cases where technical data are not listed, the figures were not available at time of publication.

## Dimensions

The dimensions can vary depending on the model version, equipment variant and measurement standards used in specific countries.

|    | Length (mm) | Width (mm) | Width across mirrors (mm) | Height, unladen (mm) |
|----|-------------|------------|---------------------------|----------------------|
| Q2 | 4191        | 1794       | 2009                      | 1538                 |

## Capacities

|   | Approximate capacities |
|---|------------------------|
| Fuel tank on vehicles without AdBlue    | 50 ltr.                |
| Fuel tank on vehicles with AdBlue       | 55 ltr.                |
| Windscreen washer                       | 3.1 ltr.               |
| Windscreen and headlight washer system* | 5.2 ltr.               |

## Weights

### Roof load

The maximum permissible roof load is 60 kg.

### Kerb weight, gross vehicle weight, axle loads

The vehicle's kerb weight including the driver (75 kg) was calculated in accordance with EU reg-

ulation 1230/2012. Optional equipment may increase the kerb weight, in which case the permitted loading capacity is reduced accordingly.

The values in the tables below are given in kg.

### Q2

|                                      | Kerb weight (unladen weight) | Gross vehicle weight      | Maximum front axle weight | Maximum rear axle weight |
|--------------------------------------|------------------------------|---------------------------|---------------------------|--------------------------|
| 1.4 TFSI, 110 kW, cylinder on demand | 1340 / 1355 <sup>a)</sup>    | 1825 / 1840 <sup>a)</sup> | 970 / 995 <sup>a)</sup>   | 905 / 935 <sup>a)</sup>  |
| 1.6 TDI, 85 kW                       | 1385                         | 1870                      | 1045                      | 925                      |
| 2.0 TDI, 140 kW, quattro             | 1555                         | 2040                      | 1125                      | 1015                     |

<sup>a)</sup> The value before the stroke applies to the manual gearbox; the value after the stroke applies to the automatic gearbox.

### Trailer weights

The figures for some markets can vary due to different export versions and testing methods.

Please note that the details listed in the vehicle's registration documents can be taken as correct. ►

## Technical data

The vertical load exerted by the trailer drawbar on the ball joint of the towing bracket must not exceed 75 kg.

The values in the tables below are given in kg.

### Q2

|                                      | Maximum rear axle weight when towing | Trailer        |                                   |                                    |
|--------------------------------------|--------------------------------------|----------------|-----------------------------------|------------------------------------|
|                                      |                                      | Without brakes | With brakes on gradients up to 8% | With brakes on gradients up to 12% |
| 1.4 TFSI, 110 kW, cylinder on demand | 980 / 1010 <sup>a)</sup>             | 670            | 1700                              | 1500                               |
| 1.6 TDI, 85 kW                       | 1000                                 | 690            | 1700                              | 1500                               |
| 2.0 TDI, 140 kW, quattro             | 1090                                 | 750            | 1800                              | 1800                               |

<sup>a)</sup> The value before the stroke applies to the manual gearbox; the value after the stroke applies to the automatic gearbox.

## Engine data

### Q2

|                                      | Max. power output (kW at rpm) | Max. torque (Nm at rpm) | Maximum speed (in km/h) |
|--------------------------------------|-------------------------------|-------------------------|-------------------------|
| 1.4 TFSI, 110 kW, cylinder on demand | 110 / 5000 - 6000             | 250 / 1500 - 3500       | 212                     |
| 1.6 TDI, 85 kW                       | 85 / 3250 - 4000              | 250 / 1500 - 3200       | 197                     |
| 2.0 TDI, 140 kW, quattro             | 140 / 3500 - 4000             | 400 / 1900 - 3300       | 218                     |

- A**
- A/C (automatic air conditioner) ..... 69
  - A/C (manual air conditioner) ..... 67
  - ABS
    - see Anti-lock brake system (ABS) ..... 145
  - Accelerator pedal ..... 272
  - Accessories ..... 60
  - Active lane assist
    - see Audi active lane assist ..... 123
  - Adaptive cruise control
    - see Audi adaptive cruise control ..... 111
  - Adaptive light
    - see Audi adaptive light ..... 49
  - AdBlue ..... 292
    - Driver messages ..... 292
    - Refilling ..... 293
    - Remaining range ..... 292
  - Additional phone ..... 175, 257
  - Advanced key
    - see Convenience key ..... 76
  - Airbag
    - Deactivating front passenger's airbag ... 288
  - Air conditioner (automatic) ..... 66
    - Adjusting air outlets ..... 71
    - AUTO (automatic mode) ..... 69
    - Controls ..... 69
    - Default settings ..... 66
    - Description ..... 66
    - Drive select ..... 131
    - Key-coded settings ..... 66
    - Supplementary heater ..... 66
    - Synchronisation ..... 69
  - Air conditioner (manual) ..... 66
    - Adjusting air outlets ..... 71
    - Controls ..... 67
    - Default settings ..... 66
    - Description ..... 66
    - Key-coded settings ..... 66
    - Supplementary heater ..... 66
  - Air distribution, adjusting
    - Automatic air conditioner ..... 70
    - Heating/ventilation system and manual air conditioner ..... 67
  - Air outlets, adjusting ..... 71
    - Automatic air conditioner ..... 70
    - Heating/ventilation system and manual air conditioner ..... 67
  - Air recirculation mode
    - Automatic air conditioner ..... 70
    - Heating/ventilation system and manual air conditioner ..... 68
  - Alarm system
    - see Anti-theft alarm system ..... 42
  - All-season tyres
    - see All-weather tyres ..... 308
  - All-weather lights ..... 49
  - All-weather tyres ..... 308
  - Alterations to the vehicle ..... 340
  - AMI
    - see Audi music interface ..... 240, 241
  - Android Auto
    - see Audi smartphone interface ..... 253
  - Announcements (traffic programme)
    - Volume ..... 261
  - Anti-dazzle interior mirror ..... 54
  - Anti-freeze
    - Coolant ..... 299
    - Windscreen washer system ..... 303
  - Anti-lock brake system (ABS) ..... 145
  - Anti-theft alarm system ..... 42
  - Anti-theft wheel bolts ..... 321
  - Apple CarPlay
    - see Audi smartphone interface ..... 253
  - Armrest (front centre) ..... 58
  - Ashtray ..... 59
  - ASR
    - see Traction control system (ASR) ..... 145
  - Audi active lane assist ..... 123
    - Cleaning area around camera ..... 313
    - Driver messages ..... 125
  - Audi adaptive cruise control ..... 111
    - Cleaning sensor ..... 313
    - Distance indicator, distance warning .... 118
    - Driver messages ..... 119
    - Traffic jam assist ..... 117
  - Audi adaptive light ..... 49, 131
  - Audi connect (infotainment) ..... 191, 203
    - Data protection ..... 205
    - Overview of services ..... 197

|   |          |   |          |
|---|----------|---|----------|
| Personal hotspot .....                                    | 195      | Selector lever lock .....                                   | 86       |
| Setting up .....  | 196      | Selector lever positions .....                              | 86       |
| Setup .....   | 191      | AUX input .....   | 241, 242 |
| Topping up data plan .....                                | 197      | Average fuel consumption .....                              | 19, 20   |
| Audi drive select .....                                   | 131      | Average speed .....   | 19, 20   |
| Audi magnetic ride  |          | Axle loads .....  | 343      |
| see Suspension control .....                              | 131      |   |          |
| Audi music interface .....                                | 240      | <b>B</b>  |          |
| Audi music stream   |          | BACK button .....   | 152      |
| see Wi-Fi .....   | 238      | Background lighting .....                                   | 53       |
| Audio files .....   | 243      | Balance (sound) .....                                       | 260      |
| Audio players   |          | Bandages  |          |
| Bluetooth audio players .....                             | 237      | see First-aid kit .....                                     | 318      |
| Wi-Fi audio players .....                                 | 238      | Bass box .....  | 325, 326 |
| Audio track .....   | 246      | Bass (sound) .....  | 260      |
| Audi phone box .....                                      | 177      | Battery .....   | 302      |
| Audi pre sense .....                                      | 120      | Charge .....  | 149      |
| Driver messages .....                                     | 119, 122 | Charging .....  | 303      |
| Settings .....  | 122      | In key .....  | 38       |
| Audi side assist .....                                    | 127      | Winter conditions .....                                     | 302      |
| Cleaning sensors .....                                    | 313      | Battery, charging (mobile devices) .....                    | 177      |
| Driver messages .....                                     | 131      | Belts   |          |
| Rear cross-traffic assist .....                           | 130      | see Seat belts .....  | 275      |
| Audi smartphone interface .....                           | 253, 258 | Bicycle racks (rear carrier systems) .....                  | 99       |
| Audi virtual cockpit                                      |          | Biodiesel .....   | 289      |
| see Instrument cluster .....                              | 12       | Bioethanol (fuel) .....                                     | 289      |
| AUTO  |          | Blower  |          |
| Automatic air conditioner .....                           | 69       | Automatic air conditioner .....                             | 70       |
| Automatic headlights .....                                | 49       | Heating/ventilation system and manual air conditioner ..... | 67       |
| Auto Lock (central locking system) .....                  | 37       | Bluetooth   |          |
| Automatic air conditioner                                 |          | Audio players .....   | 237      |
| see Air conditioner (automatic) .....                     | 66, 69   | Connecting a mobile phone .....                             | 173      |
| Automatic gearbox .....                                   | 85       | Remote SIM Access Profile .....                             | 193      |
| Back-up programme .....                                   | 92       | Settings .....  | 258      |
| Downhill speed control .....                              | 89       | Boot  |          |
| Driving tips .....  | 88       | see Luggage compartment .....                               | 272      |
| Kick-down .....   | 90       | Boot lid  |          |
| Launch control programme .....                            | 91       | Close button .....  | 44       |
| Malfunction .....   | 86       | Opening/closing electrically .....                          | 44       |
| Manual gear selection (tiptronic mode) ...                | 90       | Brakes .....  | 147      |
| Manual release of selector lever (left-hand drive) .....  | 93       | Brake assist system .....                                   | 145      |
| Manual release of selector lever (right-hand drive) ..... | 94       | Brake fluid .....   | 301      |
| Paddle levers .....                                       | 90       | Brake pedal .....   | 272      |
| Selector lever .....                                      | 88       | Electro-mechanical parking brake .....                      | 82       |

- Emergency braking function ..... 82  
 New brake pads ..... 147
- Browser  
 see Media centre ..... 244
- Bulb failure  
 Changing bulbs ..... 334
- Bulbs, changing ..... 334
- Buttons  
 Assigning functions (multi-function steering wheel) ..... 17  
 Multi-function steering wheel ..... 15, 18  
 Operating unit (MMI) ..... 152
- C**
- Cables (USB adapter/AUX adapter) ..... 240
- Calling up media ..... 243
- Call list ..... 179
- Call options ..... 187
- Capacities  
 AdBlue ..... 292  
 Fuel tank ..... 343  
 Washer fluid reservoir ..... 343
- Caps for wheel bolts, removing ..... 321
- Car care  
 Washing/cleaning ..... 312
- Care  
 see Cleaning ..... 312
- Car phone ..... 172, 188
- Catalytic converter ..... 295
- CD drive ..... 236
- Central locking system ..... 37
- Cetane number (diesel) ..... 289
- Changing settings for additional display .... 19
- Charging  
 see Power sources ..... 60
- Charging battery ..... 242
- Charging battery (mobile devices) ..... 241
- Chassis number ..... 342
- Child lock ..... 46  
 DVD ..... 246
- Child seats ..... 267  
 Fitting ..... 270
- Cigarette lighter ..... 60
- Classic view ..... 17
- Cleaning ..... 312  
 Cleaning/de-icing windows ..... 314  
 Cleaning/treating leather ..... 315  
 Cleaning Alcantara ..... 315  
 Cleaning carbon parts ..... 314, 315  
 Cleaning controls and displays ..... 314  
 Cleaning fabrics ..... 315  
 Cleaning leatherette ..... 315  
 Cleaning plastic parts ..... 314
- Closing  
 Panorama sun roof ..... 48  
 Windows ..... 46  
 see also Unlocking/locking ..... 39, 40
- Closing/opening  
 see Unlocking/locking ..... 39, 40
- Coasting mode ..... 91
- Coat hooks ..... 61
- Colour code ..... 342
- Coming home/leaving home  
 see Entry/exit lights ..... 51
- Commands (speech dialogue system) ..... 164
- Compact temporary spare wheel ..... 324
- Compartments ..... 61
- Conference calls ..... 180
- Connection manager ..... 257
- Connections  
 see Media ..... 234, 243
- Consumption (fuel) ..... 19, 20, 342
- Contacts ..... 185  
 From another directory ..... 258  
 Importing/exporting ..... 187  
 Memory capacity ..... 189  
 Storing as a destination ..... 216
- Control buttons (MMI operation) ..... 154
- Controls and displays (overview) ..... 10
- Control units ..... 150
- Convenience key  
 Manual operation ..... 79  
 Starting/stopping the engine ..... 76  
 Unlocking/locking ..... 39
- Convenience open/close ..... 47
- Cooling mode  
 Automatic air conditioner ..... 69  
 Manual air conditioner ..... 67
- Cooling system  
 Anti-freeze ..... 299  
 Checking coolant level ..... 300

Coolant temperature gauge ..... 13  
 Topping up coolant ..... 300  
 Cornering light ..... 49  
 Crosshairs ..... 209, 210  
 Cruise control system ..... 104  
 Cup holders ..... 61  
 Current fuel consumption ..... 19, 20

**D**

Data connection ..... 203  
 Data protection ..... 205  
 Date ..... 255  
 Daytime running lights ..... 49  
 Deactivating front passenger's airbag ..... 288  
 DEF  
     see AdBlue ..... 292  
 Defrosting (windows)  
     Automatic air conditioner ..... 70  
     Heating/ventilation system and manual air  
     conditioner ..... 67  
 DEF (instrument cluster) ..... 14  
 Deluxe automatic air conditioner  
     see Air conditioner (automatic) ..... 66, 69  
 Demo mode  
     see Presentation mode ..... 217  
 Destination from map  
     Via MMI touch ..... 210  
     Via rotary pushbutton ..... 209  
 Diagnostic connection ..... 150  
 Dictating  
     E-mail ..... 183  
     Text messages ..... 182  
 Diesel  
     Diesel particulate filter ..... 295  
     Fuel ..... 289  
     Preheating (glow plugs) ..... 74, 76  
 Diesel engine  
     Engine oil ..... 297  
 Diesel Exhaust Fluid (DEF)  
     see AdBlue ..... 292  
 Digital rights management ..... 234  
 Dimensions  
     Vehicle dimensions ..... 343  
 Dipped headlights ..... 49  
 Directional tread (tyres) ..... 324

Directory  
     see Contacts ..... 185  
 Display ..... 15  
     Cleaning ..... 314  
     Infotainment display ..... 153, 256  
     Instrument cluster ..... 18  
     Multi-function steering wheel ..... 15  
     Variants (MMI) ..... 153  
 Distance covered ..... 19, 20  
 Doors  
     Child lock ..... 46  
     Courtesy lighting ..... 52  
     Locking doors manually ..... 41  
     see also Unlocking/locking ..... 39, 40  
 Downhill speed control ..... 89  
 Driver information system ..... 19  
     Economy tips (analogue instrument cluster) ..... 21  
     Economy tips (Audi virtual cockpit) ..... 20  
     Efficiency program ..... 21  
     Energy consumers (Audi virtual cockpit) .. 20  
     Gear-change indicator ..... 14  
     On-board computer (analogue instrument  
     cluster) ..... 20  
     On-board computer (Audi virtual cockpit) . 19  
     Outside temperature display ..... 15  
     Service interval display ..... 304  
     Switching between displays ..... 15  
     View ..... 17  
 Drives  
     see Media ..... 234, 243  
 Drive select  
     see Audi drive select ..... 131  
 Driving on right/left ..... 52  
 Driving through water ..... 72, 85  
 Driving time ..... 19, 20  
 Dust filter  
     see Pollution filter ..... 66  
 DVD drive (media drives) ..... 235  
 Dynamic volume control  
     see System volume ..... 261

**E**

E-mail ..... 183  
 E10  
     see Ethanol (fuel) ..... 289  
 eco mode (automatic air conditioner) ..... 69



- Economical driving ..... 72
- Economical route ..... 216
- EDL  
 see Electronic differential lock (EDL) .... 145
- Efficiency program ..... 21
- Electrical socket  
 see Power sources ..... 60
- Electric windows ..... 46  
 Child lock ..... 46  
 Malfunction ..... 47
- Electro-mechanical parking brake ..... 82
- Electro-mechanical power steering ..... 148
- Electronic differential lock (EDL) ..... 145
- Electronic immobiliser ..... 38
- Electronic stabilisation control (ESC) ..... 145
- Embedded SIM card ..... 191
- Emergency assist ..... 126
- Emergency braking function ..... 82
- Emergency call, making ..... 181
- Emission control systems  
 Catalytic converter ..... 295  
 Diesel particulate filter ..... 295
- Emissions ..... 342
- Energy consumers ..... 20
- Engine  
 Coolant ..... 299  
 Driver messages ..... 77  
 Jump-starting ..... 326  
 Power output ..... 344  
 Preheating (with the button) ..... 76  
 Preheating (with the key) ..... 74  
 Start/stop system ..... 79  
 Starting/stopping (with the button) ..... 76  
 Starting/stopping (with the key) ..... 74
- Engine compartment  
 Layout ..... 297  
 Opening/closing bonnet ..... 296  
 Safety notes ..... 295
- Engine oil ..... 297  
 Checking oil level ..... 298  
 Consumption ..... 298  
 Dipstick ..... 297, 298  
 Oil change intervals ..... 304  
 Oil change service ..... 297  
 Service intervals ..... 297  
 Topping up ..... 298
- Entering information  
 Using MMI touch ..... 155  
 Using the speller ..... 159
- Entertainment drawer ..... 157
- Entry  
 Using MMI touch ..... 155
- Entry/exit lights ..... 51
- Environmental tips  
 Leaks ..... 296  
 Minimising pollution ..... 72  
 Roof carrier ..... 65
- ESC  
 see Electronic stabilisation control (ESC) . 145
- Ethanol (fuel) ..... 289
- Event data recorder ..... 150
- Extended view ..... 17
- Exterior lighting ..... 49
- Exterior mirrors ..... 53  
 Folding in ..... 53  
 Setting for automatic retraction ..... 41
- External speech dialogue system ..... 170
- F**
- Factory settings  
 Multi Media Interface ..... 256
- Fader (sound) ..... 260
- Fastening rings ..... 62, 273
- Fast forward/rewind (audio/video file) .... 243
- Fast route ..... 216
- Favourites  
 Media ..... 246  
 Navigation ..... 210  
 Telephone ..... 181
- File formats (media drives) ..... 249
- Filling the tank ..... 290  
 Fuel gauge ..... 14  
 Opening fuel tank flap ..... 290  
 Releasing tank flap manually ..... 291  
 Tank capacity ..... 343
- Finding entries  
 see Search function ..... 160, 245
- Fire extinguisher ..... 318
- First-aid kit ..... 318
- Floor mats ..... 272
- Floor panel, lowering ..... 62
- Fog light(s) ..... 49

Folding down rear seats ..... 63, 64

Four-wheel drive  
 see quattro (four-wheel drive) ..... 148

Frequency band  
 see Waveband ..... 228

Front seats ..... 58

Fuel ..... 289  
 Consumption ..... 342  
 Current fuel consumption ..... 19, 20  
 Ethanol ..... 289  
 Fuel gauge ..... 12, 14  
 Saving fuel ..... 131  
 Tank capacity ..... 343

Fuel economy  
 Coasting mode ..... 91  
 Driving style ..... 72  
 Recuperation ..... 19

Fuel range ..... 19, 20

Fuses ..... 332

**G**

GALA  
 see Speed-dependent volume control ... 260

Gearbox malfunction ..... 92

Glove box ..... 61

Ground clearance ..... 85

**H**

Halogen headlights  
 Changing bulbs ..... 334

Handbrake  
 see Electro-mechanical parking brake .... 82

Handsfree ..... 172

Hazard warning lights ..... 52

Head-protection airbag ..... 286

Head-up display ..... 25  
 Adjusting brightness ..... 53

Headlight range control ..... 49

Headlights ..... 49  
 Headlight range control ..... 49  
 Washer system ..... 55  
 Washing ..... 313

Headlights (changing bulbs) ..... 334

Head restraints  
 Adjusting ..... 58, 59  
 Removing/installing ..... 59

Head restraints, adjusting ..... 266

Heated  
 Exterior mirrors ..... 53  
 Rear window (automatic air conditioner) .. 70  
 Rear window (heating/ventilation system  
 and manual air conditioner) ..... 68  
 Seats (automatic air conditioner) ..... 70  
 Seats (heating/ventilation system and man-  
 ual air conditioner) ..... 68  
 Washer jets ..... 55

Heater (supplementary heater for diesel en-  
 gine) ..... 66

Heating/ventilation system ..... 66  
 Adjusting air outlets ..... 71  
 Controls ..... 67  
 Default settings ..... 66  
 Description ..... 66  
 Key-coded settings ..... 66  
 Supplementary heater ..... 66

Hill hold assist ..... 83

Hill starting  
 see Hill hold assist ..... 83

Hold assist ..... 84

Hold assist (hill hold) ..... 83

Home address ..... 210, 215

Horn ..... 10

Hubcaps, removing ..... 321

**I**

i-Size (securing child seats) ..... 270

Ignition  
 Switching on/off (with button) ..... 76  
 Switching on/off (with the key) ..... 74

Immobiliser  
 see Electronic immobiliser ..... 38

Importing/exporting contacts ..... 187

Inflation pressure (tyres) ..... 309

Input level (media) ..... 246

Inspection intervals ..... 304

Instrument cluster ..... 12  
 Cleaning ..... 314  
 Driver messages ..... 26

- Instruments  
  Adjusting brightness ..... 53  
Interior lights ..... 52  
Interior mirror ..... 54  
Interior monitor ..... 42  
Intermittent wipe (windscreen wipers) ..... 55  
Internet  
  see Audi connect (infotainment) ..... 191  
Internet radio ..... 239  
iPod  
  see Audi music interface ..... 240, 241  
ISOFIX (securing child seats) ..... 270  
iTunes tagging ..... 228
- J**  
Jack ..... 319, 322  
  Jacking points ..... 322  
Jack plug (3.5 mm)  
  see AUX input ..... 241, 242  
Jukebox ..... 236  
Jump-starting ..... 326
- K**  
Key-operated switch for front passenger's air-  
bag ..... 288  
Keys ..... 38  
  Driver messages ..... 77  
  Key-coded settings ..... 66  
  Key not recognised ..... 79  
Kick-down (automatic gearbox) ..... 90
- L**  
Lane assist  
  see Audi active lane assist ..... 123  
Lane change assist feature  
  see Audi side assist ..... 127  
Language, setting ..... 255  
Launch control programme ..... 91  
Left-hand traffic ..... 52  
Left control button ..... 16  
Letters, entering (using the speller) ..... 159  
Licence conditions (MMI) ..... 262  
Lights ..... 49  
  Changing bulbs ..... 334  
  Exterior ..... 49  
  Interior ..... 52  
  Interior/reading lights ..... 52  
  Right-hand traffic ..... 52  
Light sensor/rain sensor  
  Automatic headlights ..... 49  
  Switching rain sensor on/off ..... 55  
Load-through hatch ..... 64  
Locking/unlocking  
  see Unlocking/locking ..... 39, 40  
Low-profile tyres ..... 309  
Luggage compartment ..... 62  
  Boot lid ..... 43  
  Power sources ..... 60  
  Stowing luggage safely ..... 272  
Lumbar support ..... 58
- M**  
Magnetic ride  
  see Suspension control ..... 131  
Mailbox ..... 185  
Main beam headlights ..... 50  
  Main beam assist ..... 50  
Maintenance intervals ..... 304  
Make-up mirrors ..... 54  
Map  
  Display ..... 225  
  How to use ..... 219  
  Settings ..... 221  
  Update ..... 207  
Map scale, changing ..... 16  
Map update ..... 223  
Matt paintwork, washing ..... 312  
Maximum speed ..... 344  
Media ..... 234  
  Drives ..... 235  
  Media centre ..... 244  
  Media drives  
    Formats supported ..... 249  
Memory capacity  
  Directory ..... 187  
  Jukebox ..... 236  
Memory card  
  Navigation ..... 207  
  SD card readers (MMI) ..... 235  
  Types/formats supported ..... 249

Memory list  
 see Favourites ..... 231

MENU button ..... 152

Menus/symbols ..... 161

Messages ..... 182

Mileage recorder ..... 14

Mirrors ..... 53  
 Anti-dazzle setting ..... 54

MMI  
 see Multi Media Interface ..... 152

MMI search  
 see Search function ..... 160, 245

MMI touch ..... 155

Mobile hotspot  
 see Personal hotspot ..... 201

Mobile phone  
 see Telephone ..... 172

Mobile phone tray  
 see Audi phone box ..... 177

MODE button ..... 18

Modifications ..... 340

Motorway light ..... 49

Mounting pin (for changing wheels) ..... 319

MP3  
 see Jukebox ..... 236

Multi-function steering wheel  
 Operation ..... 15, 18  
 Speech dialogue system ..... 17  
 Switching between displays ..... 15  
 Switching between tabs ..... 15, 18

Multi Media Interface ..... 152

Music  
 see Media ..... 234, 243

Music collection  
 see Jukebox ..... 236

Mute ..... 261

myAudi ..... 196, 212  
 Importing contacts ..... 187  
 Logging on in the vehicle ..... 196  
 PIN ..... 196  
 Update ..... 224

**N**

Natural commands (speech dialogue system) ..... 170

NAV/MAP button ..... 207

Navigation ..... 207  
 Voice guidance ..... 218  
 see also Map ..... 219

Navigation (instrument cluster) ..... 24, 25

Network connection (Wi-Fi) ..... 201

Network selection (telephone mode) ..... 188

NOx catalytic converter  
 see AdBlue ..... 292

Numbers/characters, entering (using the speller) ..... 159

**O**

Occupant protection ..... 120

Octane rating (petrol) ..... 289

Off-road driving ..... 84

Oil  
 see Engine oil ..... 297, 298

On-board computer (analogue instrument cluster) ..... 20

On-board computer (Audi virtual cockpit) ... 19

On-board Handbook ..... 260

ON/OFF button (MMI) ..... 152

Online destinations  
 see Point of interest search ..... 212

Online map update ..... 223

Online media ..... 239

Online services  
 see Audi connect (infotainment) ..... 191

Opening ..... 37  
 Boot lid ..... 43  
 Doors ..... 39  
 Fuel tank flap ..... 290  
 Panorama sun roof ..... 48  
 Power-operated boot lid ..... 44  
 Windows ..... 46

Opening/closing  
 see Unlocking/locking ..... 39, 40

Operation  
 Multi-function steering wheel ..... 15, 18  
 Multi Media Interface ..... 153  
 Speech dialogue system ..... 164

Options menu ..... 16, 154, 158

Outside temperature display ..... 12

Overrun fuel cut-off ..... 72

Overview (controls and displays) ..... 10

**P**

|   |        |
|---|--------|
| Paddle levers (automatic gearbox) .....           | 90     |
| Paint damage .....                                | 314    |
| Paint number .....                                | 342    |
| Panorama sun roof .....                           | 48     |
| <i>see also</i> Convenience open/close .....      | 47     |
| Park assist .....                                 | 139    |
| Parking aids .....                                | 134    |
| Cleaning sensors/camera .....                     | 313    |
| Malfunction .....                                 | 144    |
| Park assist .....                                 | 139    |
| Reversing camera .....                            | 137    |
| Settings .....                                    | 143    |
| Parking brake                                     |        |
| <i>see</i> Electro-mechanical parking brake ..... | 82     |
| Parking lights .....                              | 50     |
| Parking (automatic gearbox) .....                 | 88     |
| Particulate filter (diesel) .....                 | 295    |
| Passenger's door, locking manually .....          | 41     |
| Path descriptions in Owner's Manual .....         | 154    |
| Pause (audio/video file) .....                    | 243    |
| Pedals .....                                      | 272    |
| Performance (engine) .....                        | 344    |
| Personal hotspot .....                            | 201    |
| Personal route assist .....                       | 214    |
| Personal Wi-Fi hotspot .....                      | 195    |
| Petrol .....                                      | 289    |
| Petrol engine                                     |        |
| Engine oil .....                                  | 297    |
| Phone book  |        |
| <i>see</i> Contacts .....                         | 185    |
| Picture format (video) .....                      | 246    |
| Playback (media) .....                            | 243    |
| Playlist .....                                    | 246    |
| Point of interest search .....                    | 212    |
| <i>see also</i> Special destination .....         | 211    |
| Polishing .....                                   | 314    |
| Pollen filter                                     |        |
| <i>see</i> Pollution filter .....                 | 66     |
| Pollution filter .....                            | 66     |
| Power management .....                            | 149    |
| Power sources .....                               | 60     |
| Preheating (glow plugs) .....                     | 74, 76 |
| Presentation mode .....                           | 217    |
| Pressures (tyres) .....                           | 307    |

|                 |     |
|-----------------|-----|
| Privacy .....   | 234 |
| Programme guide |     |
| Radio .....     | 229 |

**Q**

|                                      |     |
|--------------------------------------|-----|
| quattro (four-wheel drive) .....     | 148 |
| Selective wheel torque control ..... | 145 |

**R**

|  |        |
|--|--------|
| Radio .....  | 228    |
| Detailed station information .....                             | 230    |
| Radio text .....   | 229    |
| Station list .....   | 228    |
| Radio equipment .....  | 340    |
| Radio frequency  |        |
| <i>see</i> Waveband .....                                      | 228    |
| Radio transmitters .....                                       | 340    |
| Rain sensor/light sensor                                       |        |
| Automatic headlights .....                                     | 49     |
| Switching rain sensor on/off .....                             | 55     |
| Random playback .....  | 246    |
| Reading lights .....   | 52     |
| Rear armrest   |        |
| <i>see</i> Cup holders .....                                   | 61     |
| Rear carrier systems .....                                     | 99     |
| Rear lights (changing bulbs) .....                             | 334    |
| Rear of vehicle  |        |
| Boot lid .....   | 43     |
| Washing rear window .....                                      | 55     |
| Rear window heating  |        |
| Automatic air conditioner .....                                | 70     |
| Heating/ventilation system and manual air<br>conditioner ..... | 68     |
| Recommended gear .....   | 14     |
| Recuperation .....   | 19     |
| Reminder signal .....  | 255    |
| Remote control keys .....                                      | 38     |
| Repairs .....  | 340    |
| Replacement parts .....  | 340    |
| Reset  |        |
| <i>see</i> Restart (MMI) .....                                 | 262    |
| Reset button (trip recorder) .....                             | 14     |
| Restart (MMI) .....  | 262    |
| Rest recommendation .....                                      | 110    |
| Retaining hooks .....  | 61, 63 |



- Navigation ..... 217
  - Radio ..... 231
  - Speech dialogue system ..... 256
  - System (MMI) ..... 255
  - Telephone ..... 187
  - Shuffle
    - see Random playback ..... 246
  - Side airbag ..... 285
  - Side assist
    - see Audi side assist ..... 127
  - Side lights ..... 49
  - SIM card
    - see Embedded SIM card ..... 191
  - SIM card reader ..... 176, 191, 192
  - Smartphone
    - see Telephone ..... 172
  - SMS
    - see Text messages ..... 182
  - Snow chains ..... 309
  - Software update
    - see Map update ..... 200
    - see System update (MMI) ..... 259
  - Software (MMI)
    - Licence conditions ..... 262
    - Update ..... 259
    - Version ..... 259
  - Sound settings ..... 260
  - Source overview ..... 243
  - Spanner ..... 319
  - Spare key ..... 38
  - Spare wheel ..... 324
  - Special destination ..... 211
  - Speech dialogue system ..... 164
    - Commands ..... 165
    - External ..... 170
    - Multi-function steering wheel ..... 17
    - Operation ..... 164
    - Settings ..... 256
    - Volume ..... 262
  - Speed-dependent volume control ..... 261
  - Speed limit display
    - see Traffic sign recognition ..... 108
  - Speed limiter ..... 106
  - Speed limits
    - see Traffic sign recognition ..... 108
  - Speedometer ..... 12
  - Speed warning ..... 104
  - Speller ..... 159
  - Start/stop system ..... 79
  - START ENGINE STOP (convenience key) . 76, 77
  - Starting with jump leads ..... 326
  - Station memory
    - see Favourites ..... 231
  - Station search (radio)
    - see Updating station list (radio) ..... 231
  - Steering ..... 148
    - Locking (button) ..... 77
    - Locking (ignition lock) ..... 75
  - Steering wheel
    - Adjusting ..... 74
    - Paddle levers (automatic gearbox) ..... 90
    - see also Multi-function steering wheel ..... 15, 17, 18
  - Stopover (navigation) ..... 213
  - Storage compartments ..... 61
  - Streaming
    - see Online media ..... 239
  - S tronic (automatic gearbox) ..... 85
  - Subtitles (DVD) ..... 246
  - Subwoofer ..... 261
  - Sun roof
    - see Panorama sun roof ..... 48
  - Sun visors ..... 54
  - Supplementary heater (vehicles with diesel engine) ..... 66
  - Surround sound ..... 261
  - Suspension control ..... 131
  - Switching between calls ..... 180
  - Switching between tabs
    - see Multi-function steering wheel . 15, 17, 18
  - Switching character sets (MMI touch) ..... 155
  - Symbols ..... 161
    - Navigation ..... 219
    - Traffic ..... 225
  - System settings (MMI) ..... 255
  - System update (MMI) ..... 259
  - System volume ..... 261
- ## T
- TDI clean diesel
    - see AdBlue ..... 292

|  |          |  |          |
|--|----------|--|----------|
| Technical data .....   | 342      | Traffic information .....                    | 225, 226 |
| Telephone .....  | 172      | Traffic jam assist .....                     | 117      |
| Audi phone box .....   | 177      | Traffic programme (TP) .....                 | 229      |
| Connecting .....   | 173      | Traffic sign recognition .....               | 108      |
| Dialling a number .....  | 179      | Trailer mode (navigation) .....              | 217      |
| Options during a call .....                                    | 180      | Trailer stabilisation .....                  | 97       |
| Playing music .....  | 237      | Travel guide .....                           | 200      |
| Settings .....   | 187      | Treble (sound) .....                         | 260      |
| SIM card .....   | 176      | Trip recorder, resetting .....               | 14       |
| Telephone mode .....   | 188      | Turning light .....                          | 49       |
| Temperature display  |          | Turn signals .....                           | 50       |
| Coolant .....  | 12       | Type plate .....                             | 342      |
| Outside temperature .....                                      | 15       | Tyre Mobility System (tyre repair kit) ..... | 319      |
| Temperature selection  |          | Tyres .....                                  | 305      |
| Automatic air conditioner .....                                | 69       | Changing .....                               | 321      |
| Heating/ventilation system and manual air<br>conditioner ..... | 67       | Directional tread .....                      | 324      |
| Tethering .....  | 195      | Inflation pressure .....                     | 307      |
| Text messages .....  | 182      | Low-profile tyres .....                      | 309      |
| Tightening torque (wheel bolts) .....                          | 324      | quattro (four-wheel drive) .....             | 148      |
| Time .....   | 255      | Repair kit .....                             | 319      |
| tiptronic (automatic gearbox) .....                            | 85, 90   | Service life .....                           | 306      |
| TMC/TMCpro   |          | Tyre pressure loss indicator .....           | 309      |
| see Traffic information .....                                  | 225      | Tyre pressure (towing a trailer) .....       | 96       |
| Tools .....  | 319      | Wear indicator .....                         | 306      |
| Top tether and ISOFIX (securing child seats)                   | 271      |  |          |
| Torque   |          | <b>U</b>                                     |          |
| Engine .....   | 344      | Unlocking/locking                            |          |
| Wheel bolts .....  | 324      | By remote control .....                      | 39       |
| Touch pad  |          | Using the central locking switch .....       | 40       |
| see MMI touch .....  | 155      | With key .....                               | 41       |
| Tourist guide  |          | With the convenience key .....               | 39       |
| see Travel guide .....   | 200      | Updating station list (radio) .....          | 231      |
| Tow-starting .....   | 328      | USB charging socket .....                    | 60, 242  |
| Towing .....   | 96       | USB stick                                    |          |
| Parking aids .....   | 144      | see Audi music interface .....               | 240, 241 |
| Trailer weights .....  | 96, 343  |  |          |
| Towing away .....  | 328      | <b>V</b>                                     |          |
| Tow-away protection .....                                      | 42       | Vehicle                                      |          |
| Towline anchorage .....  | 330, 331 | Raising .....                                | 322      |
| TPMS   |          | Taking out of service .....                  | 317      |
| see Tyres .....  | 309      | Vehicle data                                 |          |
| Traction control system (ASR) .....                            | 145      | Identification data .....                    | 342      |
| Traffic announcements  |          | Version information .....                    | 259      |
| see Traffic programme (TP) .....                               | 229      | VIEW button .....                            | 15       |
| Traffic avoidance .....  | 217      |  |          |



- Voice guidance  
 see Multi-function steering wheel . 15, 17, 18
- Volume ..... 261
- W**
- Warning lamps ..... 26
- Warning triangle ..... 318
- Wash/wipe ..... 55
- Washing ..... 312
- Washing ornamental trim/mouldings 313, 314
- Washing rear lights ..... 313
- Washing tailpipes ..... 313
- Waveband ..... 228, 230  
 see also Waveband ..... 228
- Weights ..... 343
- Wheel bolt caps  
 Removing ..... 321
- Wheel bolts ..... 308  
 Anti-theft ..... 321  
 Loosening ..... 322  
 Torque ..... 324
- Wheel imbalance ..... 306
- Wheels ..... 305  
 Changing ..... 321, 323  
 Washing ..... 313
- Wi-Fi  
 Audi music stream ..... 238  
 Audio players ..... 238  
 Hotspot ..... 201  
 Online media ..... 239  
 see also Personal Wi-Fi hotspot ..... 195
- Windows ..... 46  
 Cleaning/de-icing ..... 314
- Windscreen  
 Washing ..... 55
- Windscreen washer system ..... 55, 303  
 Reservoir capacity ..... 343
- Windscreen wipers ..... 55  
 Changing the wiper blades ..... 56
- Winter conditions  
 Cooling system ..... 299  
 De-icing windows ..... 314  
 Defrosting windows (automatic air conditioner) ..... 70  
 Defrosting windows (heating/ventilation system and manual air conditioner) ..... 67
- Diesel ..... 289
- Seat heating (automatic air conditioner) .. 70
- Seat heating (heating/ventilation system and manual air conditioner) ..... 68
- Snow chains ..... 309
- Vehicle battery ..... 302
- Washing the vehicle ..... 312
- Windscreen washer system ..... 303
- Winter tyres ..... 308
- Wiper blades, changing ..... 57
- WLAN  
 see Wi-Fi ..... 238
- Wrench ..... 319
- Z**
- Zooming (map) ..... 209, 210, 219



AUDI AG works continuously to develop and further improve all products and models. AUDI AG reserves the right to alter any part of the vehicle and its equipment or technical specifications at any time. The Owner's Manual is based on the information available at the time of printing. No legal commitment can therefore be implied by the information, illustrations or descriptions in this publication.

No part of this publication may be reprinted, reproduced or translated without the written permission of AUDI AG. AUDI AG reserves the right

to change the information in this publication without prior notice. All rights under the laws of copyright are expressly reserved by AUDI AG.

AUDI AG, Auto-Union-Straße 1,  
85045 Ingolstadt, Germany

© 2016 AUDI AG



**For the sake of the environment**

This environmentally friendly paper was bleached without the use of chlorine.

**Owner's Manual**  
**Englisch 11.2016**  
**81A012720AB**



81A012720AB

[www.audi.com](http://www.audi.com)